

APM series Power Meters

Installation and Operation Instruction V2.5

ACREL CO.,LTD

DECLARATION

No part of this publication may be reproduced, stored in a retrieval system, or transmitted in any form by any means, electronic, mechanical photocopying, recording, or otherwise without prior permission of Acrel. All rights reserved.

This company reserves the power of revision of product specification described in this manual, without notice. Before ordering, please consult local agent for the latest specification of product.

CONTENTS

1. Overview.....	1
2. Type and specification.....	1
3. Technical Parameters.....	2
4. Installation and wiring instructions.....	4
4.1 Installation dimensions.....	4
4.2 Wiring method.....	4
5. Packaging.....	7
6. Engineering Construction Notes.....	7
6.1 Voltage input.....	7
6.2 Current input.....	7
6.3 Communication Wiring.....	7
6.4 supply voltage.....	8
7. Operation instructions.....	8
7.1 Display description.....	8
7.2 Panel description.....	9
7.3 Display overview.....	10
7.4 Measurement Parameters.....	13
7.5 System Settings.....	22
7.6 Resetting data.....	34
8. Modbus Communication instructions.....	35
8.1 Intruduction.....	35
8.2 Communication Address Table.....	35
8.3 Correspondence between communication value and actual value.....	53
9 Ethernet Communication Guide.....	57
9.1 Ethernet Parameter Modification.....	57
9.2 Extension of RS485 Communication.....	58
10 Description of multiple rate energy.....	61
10.1 Viewing the multiple rate energy.....	61
10.2 Multiple Rate Setting.....	62
10.3 Multiple rate electrical energy communication address table.....	64
11 DL/T-645 Communication Guide.....	69
11.1 DL/T645-2007 Brief description of the agreement.....	69
11.2 transmission method.....	69
11.3 protocol.....	69
12 Profibus-DP guide.....	80
12.1 Profibus-DP Protocol overview.....	80
12.2 Profibus Communication function configuration.....	82
13. Profinet.....	87
13.1 connection preparation.....	87
13.2 Configuration Configuration.....	89
13.3 mailing address list.....	92
14. Analysis of common fault.....	94

1. Overview

APM series power meters of ACREL are power meters that are designed according to IEC standards and synchronized with international advanced technology.

APM series meters have full power measurement, energy statistics, analysis of power quality and network communications and other functions, are mainly used for comprehensive monitoring of the quality of power supply network.

This series of meters use a modular design, with a rich function of the external DI / DO module, AI / AO module, event recording (SOE) module with T-Flash (TF) card, network communication module, Temperature and humidity measurement module, can achieve full power measurement of electrical circuit and monitoring of switch status, Dual RS485 with Ethernet interface can realize data copying of RS485 master station, eliminating the need for data switching exchange. PROFIBUS-DP interface can realize high-speed data transmission and networking function.

2. Type and specification

Function		APM800 (class 0.5s)	APM801 (class 0.2s)	APM810 (class 0.5s)
Measured parameters	Total electrical measurement	√	√	√
	Four-quadrant energy	√	√	√
Pulse output of energy	Pulse output of active/reactive energy	√	√	√
Demand	Three-phase current, active power, reactive power, real-time demand of apparent power, and maximum demand (including time stamp)	√	√	√
Extreme value statistics	Extremum of current, line voltage, phase voltage, active power, reactive power, apparent power, power factor, frequency, total harmonic of current, total harmonic of voltage in this month and last month (including time stamp)	√	√	√
Power quality	Unbalance of current, line voltage, phase voltage	√	√	√
	Voltage phase angle, current phase angle	√	√	√
	Voltage current phase Angle	√	√	√
	Total (odd, even) harmonic content of voltage and current	×	×	√
	Harmonic content of voltage and current (2-63 times)①	×	×	√
	Voltage crest factor	×	×	√
	Telephone waveform factor	×	×	√
Alarm records	Current K-factor	×	×	√
	A total of 66 kinds of alarm types, each type can record the most recent 16 alarm records, support extended records by TF card	√	√	√
Event log	Record the most recent 128 event records, support extended records by TF card	√	√	√
Communication	Modbus protocol	√	√	√
I/O	2 digital inputs + 2 digital outputs (2DI+2DO)	√	√	√
Extensions	MD82 8 digital inputs + 2 digital outputs with changeover contacts (8DI+2DO)	√	√	√

	MLOG	TF card storage (alarm records, event records, electrical parameters and energy timing records, etc.)	√	√	√
	MA84	8 analog inputs (class 0.5) + 4 analog outputs (class 0.5) (8AI+4AO)	√	√	√
	MCM	1 RS485/Modbus-RTU, support master mode or slave mode	√	√	√
	MCP	1 Profibus-DP	√	√	√
	MCE	1 Ethernet, support Modbus-TCP, http, SMTP, DHCP protocol	√	√	√
	MTH	4 ways 2m of temperature measurement, 1 way of temperature and humidity control	√	√	√
		4 ways 4m of temperature measurement, 1 way of temperature and humidity control	√	√	√
	MTP	2 ways of PT100 temperature measurement	√	√	√
	MTH	1 way of temperature and humidity control	√	√	√

Note : Accuracy of 2~42 times harmonic measurement in the frequency range of 45~65Hz is 1%, accuracy of 43~63 times harmonic measurement in frequency 50Hz is 2%.

3. Technical Parameters

Technical Parameters	Index		
Signal	Electrical network	Three-phase three-wire, three-phase four-wire, see the wiring diagram;	
	Frequency	45~65Hz;	
	Voltage	Rated value: AC 100V、110V、400V、690V;	
		Overload: 1.2 times rated value(continuous); 2 times rated value /1 second;	
		Power consumption: < 0.5VA (per channel);	
	Current	Rated value: AC 1A, 5A, support 4 mm ² line access;	
Overload: 1.2 times rated value(continuous); 10 times rated value/1 second;			
Power consumption: < 0.5VA (per channel);			
Measurement accuracy	Voltage、 current and power	class 0.5s/class 0.2s (APM800、 APM810/APM801)	
	Active power	class 0.5s/class 0.2s (APM800、 APM810/APM801)	
	Reactive power	class 2	
	Harmonic	1% (2rd~42nd) 、 2% (43rd~63rd)	
Switch inputs	Dry contact inputs, built-in power supply;		
Relay outputs	Contact type: open contact in main part, changeover contact in module; Contact capacity: AC 250V/3A DC 30V/3A;		
Pulse output of energy	Output mode: Optocoupler pulse with open collector; Pulse constant: 4000 (5A) 、 8000 (1A) imp/kWh;		

Analog outputs		DC 0mA~20mA、4mA~20mA、0V~5V、1V~5V output, accuracy class 0.5%, load resistance $\leq 500\Omega$;
Analog inputs		DC 0mA~20mA、4mA~20mA、0V~5V、1V~5V input, accuracy class 0.5%
Storage card		Standard Capacity:4G,TF Card Up to 32G Capacity;
Communication		RS485 interface/Modbus-RTU protocol and DLT645 protocol Profibus-DP interface/Profibus-DP protocol; RJ45 interface (Ethernet) / Modbus-TCP, http, DHCP and other protocols;
Power supply		Working range: AC/DC 85V~265V or AC/DC 115~415V(P2); Power consumption: Power consumption of the main part $\leq 15VA$;
Safety	Power frequency withstand voltage	The power frequency withstand voltage between the shell and the auxiliary power supply, each input and output terminal group is AC 4kV/1min; The power frequency withstand voltage between the auxiliary power supply and each input and each output terminal group is AC 2kV/1min; The power frequency withstand voltage between the voltage input and other input/output terminal groups is AC 2kV/1min; The power frequency withstand voltage between the current input and other input/output terminal groups is AC 2kV/1min; The power frequency withstand voltage between the relay output and other input/output terminal groups is AC 2kV/1min; The power frequency withstand voltage between each terminal group of switch input, communication, analog output and pulse output is AC 1kV/1min;
	Insulation resistance	Inputs、 outputs to the shell $>100M\Omega$;
Electromagnetic compatibility		Meet IEC 61000 standard (Level 4);
Protection level		Display panel IP52
Environment		Operating temperature: -20 °C ~ +65 °C; Storage temperature: -20°C~+70°C; Relative humidity: $\leq 95\%$ without condensation; Altitude: $\leq 2500m$;
Standards	IEC 60068-2-1 IEC 60068-2-2 IEC 60068-2-30	Environmental Testing-Part 2-1:Tests Test A:Cold IDA Part 2-1:Tests Test B:Dry heat Part 2-30:Tests Test Db:Damp heat,cyclic(12+12h)
	IEC 61000-4	Electromagnetic compatibility-Testing and measurement techniques
	IEC 61557-12	Electrical safety in low voltage distribution system up to 1000V a.c. and 1500V d.c –Equipment for testing,measuring or monitoring of protective measures- Part12: Performances measuring and monitoring devices(PMD)
	IEC 62053-22	Electricity metering equipment (a.c.)-Particular requirements - Part22:Static meter for active energy (class 0.2s and 0.5s)

4. Installation and wiring instructions

4.1 Installation dimensions

Meter and panel opening size(unit: mm(in))

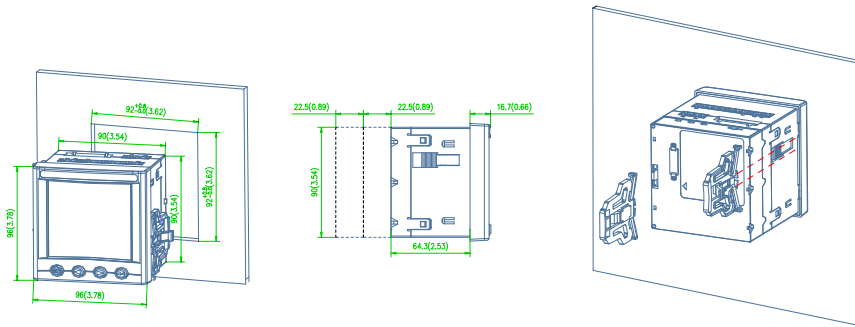

Note: The maximum clamshell Angle is 90°.

Multiple meter installation (unit: mm(in))

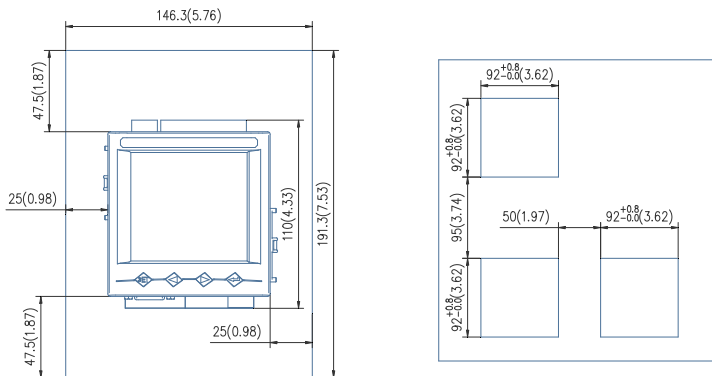

4.2 Wiring method

According to different design requirements, it is recommended to add a fuse (BS88 2A gG) to the power supply and voltage input terminals to meet the safety requirements of the relevant electrical specifications.

4.2.1 Main part

Terminal diagram: "4,5,6,7,8,9" is the current signal input terminal number; "11,12,13,14" the voltage signal input terminal number; "1, 2" is the meter auxiliary power terminal number. "21, 22" is the communication terminal number; "17, 18, 19, 20" is the energy pulse output terminal number; "30, 31, 39" is the switch input terminal number; "40, 41, 42, 43 " is the relay output terminal number. (Figure 1)

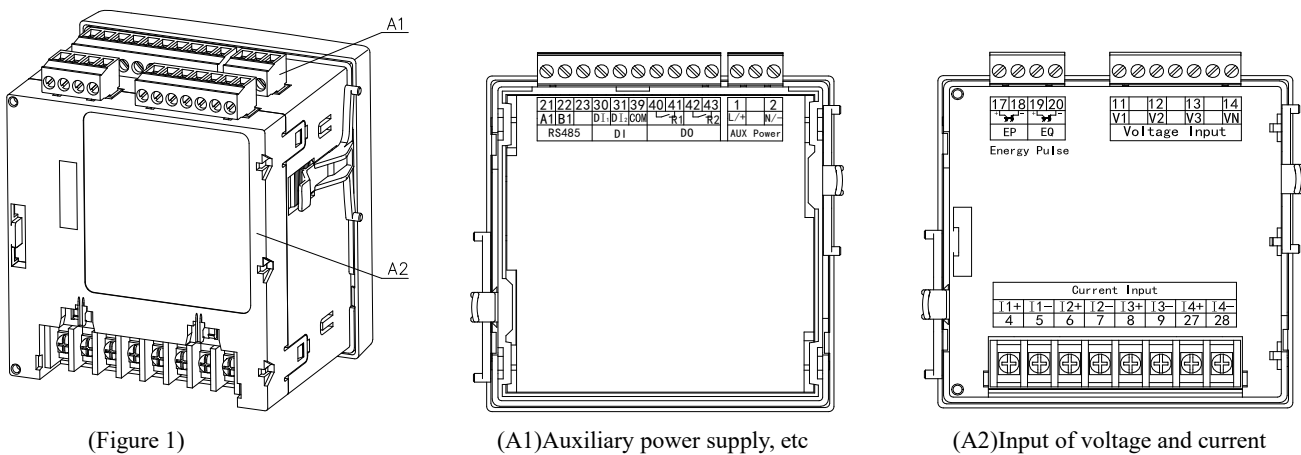

(Figure 1)

(A1)Auxiliary power supply, etc

(A2)Input of voltage and current

Wiring method of signal input:

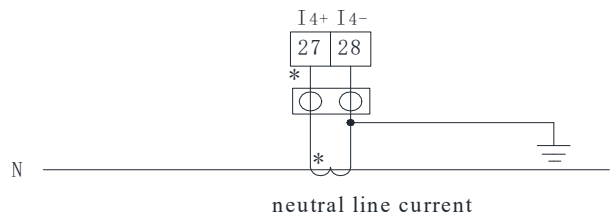
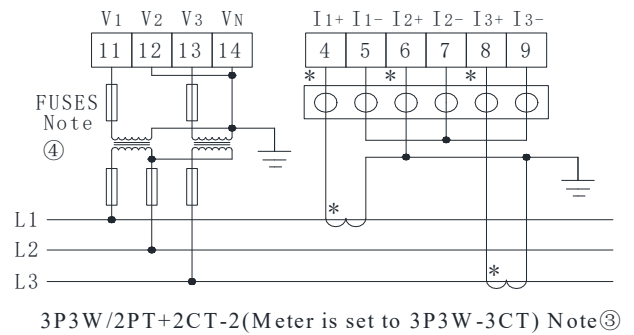
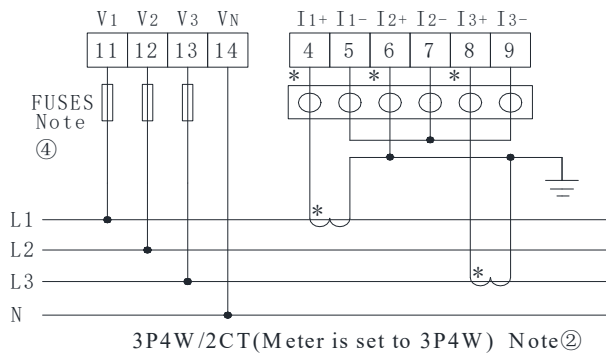
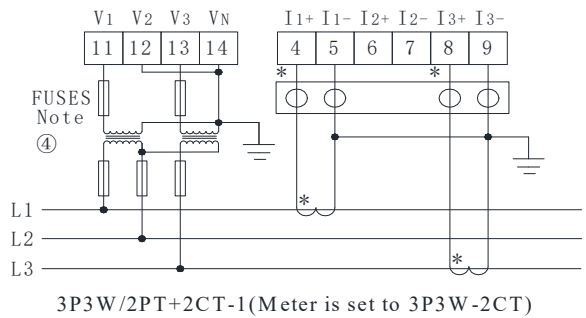
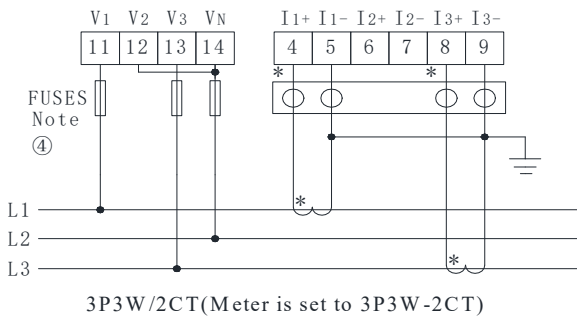
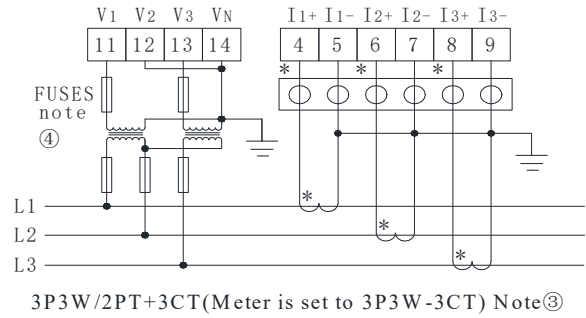
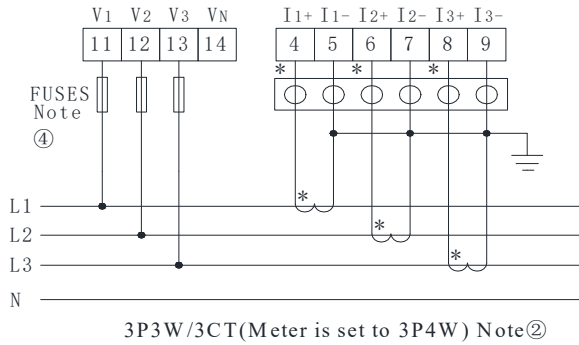
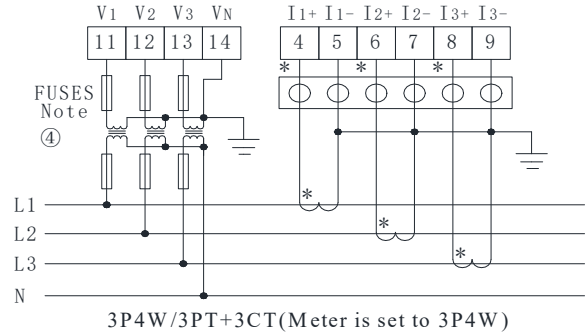
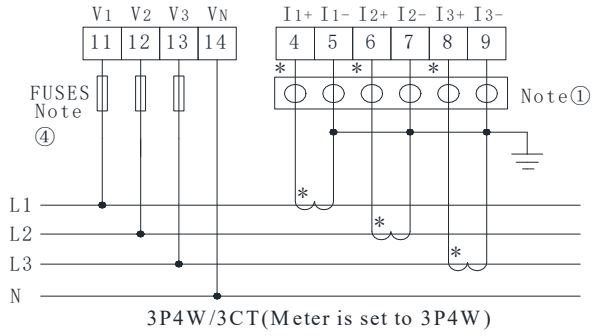

NOTE①: This is a test terminal for shorting the secondary side of the CT.



NOTE②: Only for balanced three-phase loads.

NOTE③: Phase B current is only displayed and does not participate in other calculations.

NOTE④: FUSES must be equipped with a fuse with a rated current of 1A.

4.2.2 Module parts

Switch module

70	77	71	72	78	73	30	31	32	33	34	35	36	37	39
 R1		 R2		DI ₁	DI ₂	DI ₃	DI ₄	DI ₅	DI ₆	DI ₇	DI ₈	COM ₄		
Relay Output						Digital Input								

Analog input and output module

60	61	62	63	64	65	66	67	69	50	51	52	53	59
AI ₁	AI ₂	AI ₃	AI ₄	AI ₅	AI ₆	AI ₇	AI ₈	COM ₂	AO ₁	AO ₂	AO ₃	AO ₄	COM ₃
Analog Input									Analog Output				

Ethernet module

24	25	26											
A2	B2												
RS485													

MTP Temperature module(2*PT100)

85	84	83	82	81	80
Thermometry					
PT2g	PT2b	PT2a	PT1g	PT1b	PT1a

MTN Temperature module(4*NTC)

87	86	85	84	83	82	81	80
Thermometry							
NTC4	NTC3	COM2	NTC2	NC	COM1	NTC1	NC

MTH Temperature module (WHD)

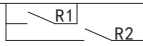
76	75	74	93	92	91	90	87	86	85	84	83	82	81	80
Relay			Sensor				Thermometry							
 R1 R2			V-	SDA	SCL	V+	NTC4	NTC3	COM2	NTC2	NC	COM1	NTC1	NC

Note: NTC1 and NTC2 share common terminal COM1, NTC3 and NTC4 share common terminal COM2.

An example of wiring for the communication is shown in the figure below:

Correct wiring method: Communication Cable shield is connected to earth.

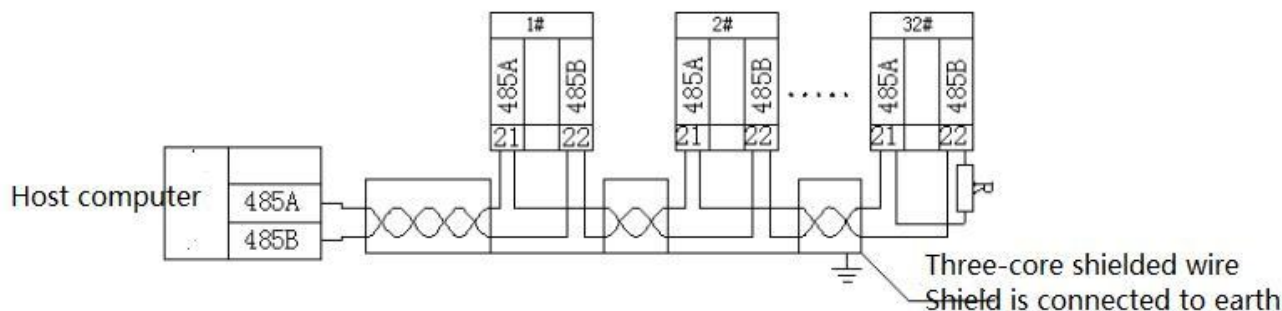

It is recommended to add a matching resistor between A and B at the end of the meter. The resistance range is 120Ω~10 kΩ.

Note: 1. When the meter has Profibus function, for the related communication configuration and GSD file, please refer to the CD delivered with the meter.

2. The second RS485 communication only supports Modbus 03 command.

5. Packaging

The package contains the following items: Host (including plug-in terminal block), mounting brackets, factory inspection report, certificate (anti-counterfeiting label), installation instructions.

When opening the product packaging, please check carefully whether there is any damage. If any damage occurs, please inform ACREL company or agent promptly, and keep the damaged external packaging. The company will promptly replace it.

6. Engineering Construction Notes

6.1 Voltage input

The input voltage should not exceed 120% of the rated input voltage of the product (100V or 110V or 400V or 690V). Otherwise, the PT should be used; a 1A fuse must be installed on the voltage input; the wiring method of the product must be set according to the PT wiring of the product. The wiring method is as follows:

Wiring method	Selection
2 elements	3P3W
3 elements	3P4W

6.2 Current input

The standard rated input current is 1A or 5A. It requires the use of an external CT (recommended to use a wiring strip, not directly connected to the CT, in order to facilitate disassembly); ensure that the input current corresponds to the voltage, the phase sequence is consistent and the direction is consistent; if There are other meters connected in the CT circuit used, the wiring should be connected in series.

Before removing the current input connection of the product, be sure to disconnect the CT primary circuit or short the secondary circuit!

6.3 Communication Wiring

The meter provides asynchronous half-duplex RS485 communication interface, using MODBUS-RTU protocol, various data information can be transmitted on the communication line.

Theoretically, up to 128 power meters can be connected simultaneously on a single line. Communication address of each power meter can be set. When wiring, keep communication lines away from power cables or other strong electric-magnetic field

6.4 supply voltage

The conventional power supply voltage of the instrument:AC/DC 85-265V;supply voltage with P2 funcion:AC/DC 115-415V.

7. Operation instructions

7.1 Display description

APM series uses LCD segment LCD display, the following table shows the segment codes for different characters.

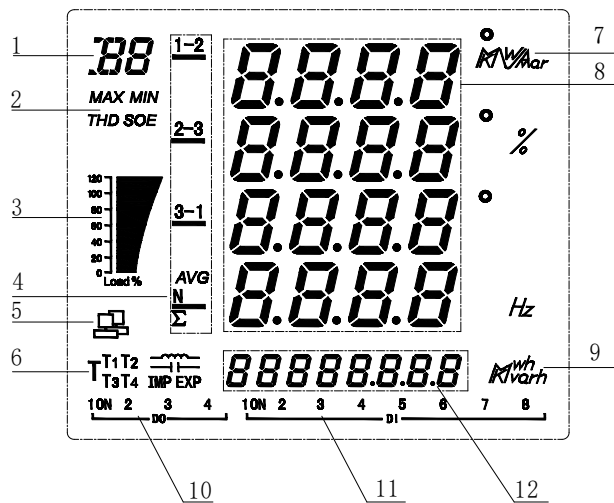

A	b	c	d	E	F	g	H	i/I	
R	b	c	d	E	F	9	H	,	l
J	K	L	M	n	o	P	q	r	S
J	K	L	ñ	n	o	P	q	r	S
t	U	v	W	X	y	Z	-	-	=
t	U	v	y	4	4	2	-	-	=

The following figure shows the screen when all character fields and indications are all lit.



The following table is a description of all the measurement and indication.

No.	Display content	Instruction
1	I/U/P/Q/S/PF/d	Identify what is displayed in the current measurement data display area 8: Current / Voltage / Active Power / Reactive Power / Apparent Power / Power Factor / Demand
	IO/AL/SD	DI, DO, AI, AO status/alarm log/TF card status
2	MAX/ MIN	Records of maximum / minimum
	THD	Total harmonic distortion

	SOE	Sequence Of Event
3	 Display of load size	Indicate the percentage of the current load current relative to the rated current, 90% to 110%, the histogram shows 100%, and so on.
4	1-2,2-3,3-1	1、2、3: Values of ABC three-phase, 1-2,2-3,3-1: Value of the AB, BC, CA three-line
	AVG	Average value
	N	Neutral current
	Σ	Total power
5	 Communication status symbol	Lights up to indicate that the current communication is being sent and received normally
6	IMP/ EXP/ 	Absorption total active energy / release total active energy / inductive reactive energy / capacitive reactive energy
	T1, T2, T3, T4, T5, T6, T7, T8, T	T1-T5: Correspond to tip, peak, flat, valley and deep valley respectively, T6-T8 reserved. T: Indicating the total energy for the month
7	Unit of measurement data	Current: A, kA; Voltage: V, kV; Active power: kW, MW; Reactive power: kVar, MVar; Apparent power: kVA, MVA; Percentage: %; Frequency: Hz
8	Display area of measurement data	Current, voltage, power, power factor, time, parameter settings, etc.
9	Units of energy	Active energy: kWh, MWh; Reactive energy: kVarh, Mvarh
10	DO status indication	The status of DO1-DO4. The remaining DO can be viewed under the main loop IO
11	DI status indication	The status of DI1-DI8. The remaining DI can be viewed under the main loop IO
12	Energy data area	Left and right navigation bar, corresponding to the left and right buttons menu; Electrical measurement display and parameter setting

The meter will display the model number and version information, and then the current interface will be displayed.

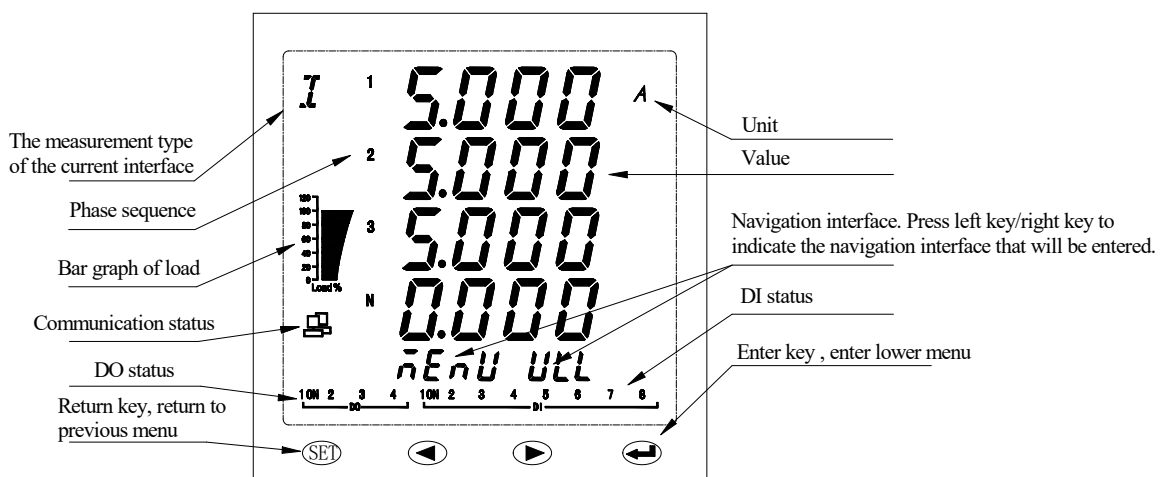

7.2 Panel description

Key description

The four keys are, the SET key, the left key, the right key, and the enter key from left to right.





Key	Function
SET	Return to previous menu

Left	Decrease parameter or switch navigation interface
Right	Increase parameter or switch navigation interface
Enter	Modify and confirm the parameters or enter the next menu



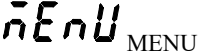

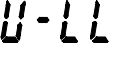
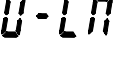
Extended module indicator light description

	Flashing (1s)	Flashing (0.2s)	Bright	Extinguished
(GREEN)	Module OK	Module error	/	Module is not running

7.3 Display overview

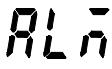
First level menu	Second level menu	Third level menu	Fourth level menu	Note	
 MENU	SET (Settings)			See the system settings for details	
	RST (Reset)	E (Clear energy)			See data reset for details
		dMd (Clear demand)			
		ALM (Clear alarm record)			
		SOE (Clear event record)			
		MAX MIN (Clear extremum)			
		SD (Format TF card)			
	DIAG (diagnosis)	Version, Software number, Module version			
 I (current)	I_Unablance (Unbalance of current)				
	Current phase angle				
	Voltage current phase Angle				
 In (neutral current)					
 ULL (line voltage)	U_Unablance (unbalance of line voltage)				
	Offset (Line voltage offset)				
 ULN (phase voltage)	V_Unablance (Unbalance of phase voltage)				
	offset (Phase voltage deviation)				
	Angle (Voltage phase angle)				
					

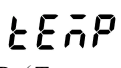

P (active power)				
Q Q (reactive power)				
S S (apparent power)				
E E (energy)	IMP (Absorb active energy)			See energy view for details
	EXP (Release active energy)			
	EQL (Inductive reactive energy)			
	EQC (Capacitive reactive energy)			
d d (current demand for three-phase current)	Current active power demand			See demand view for details
	Current reactive power demand			
	Current apparent power demand			
	Phase A current maximum demand and time of occurrence			
	Phase B current maximum demand and time of occurrence			
	Phase C current maximum demand and time of occurrence			
	Active power maximum demand and time of occurrence			
	Reactive power maximum demand and time of occurrence			
Apparent power maximum demand and time of occurrence				
PF PF (power factor)				
THD THD	UH THD (Total harmonic distortion of phase voltage)	2-63 harmonics of three phase voltage		See harmonics for details
	UH ODD (Total odd harmonic distortion of phase voltage)			
	UH EVEN (Total even harmonic distortion of phase voltage)			
	IH THD (Total harmonic distortion of current)	2-63 harmonics of three phase current		
	IH ODD (Total odd harmonic distortion of current)			
	IH EVEN (Total even harmonic distortion of current)			
	CF (Crest factor)			
THFF (Telephone waveform factor)				
KF (K factor)				
IO IO (Inputs and outputs)	DI (Digital input)			See IO for details
	DO (Digital output)			
	AI (Analog input)			

	AO (Analog output)			
 MAX/MIN (Maximum and minimum)	I (Current)	Maximum of this month and time of occurrence;		See the maximum and minimum for details
	U (Voltage)			
	P (Active power)	Minimum of this month and time of occurrence;		
	Q (Reactive power)			
	S (Apparent power)	Maximum of last month and time of occurrence;		
	PF (Power factor)			
	F (Frequency)	Minimum of last month and time of occurrence;		
THD (Total harmonic distortion)				
 ALM (Alarm record)	LAST ALM (last 16 alarm records)	Detailed alarm record		See the alarm for details
	AT01 (Overcurrent alarm)	1 A (Phase A overcurrent)	Alarm details	
		2 B (Phase B overcurrent)	...	
		3 C (Phase C overcurrent)	...	
		4 MAX (Maximum overcurrent)	...	
		5 N (Neutral overcurrent)	...	
	AT02 (Undercurrent alarm)	
...		
AT13 (Other alarm)		
 SOE (Event record)	Record of the last 128 events			
 TF (TF card capacity)				
 TIME (system time)				
 TEMP (Temperature)	4-way temperature			
	1-way temperature and humidity			
	Heated/blown state			

7.4 Measurement Parameters

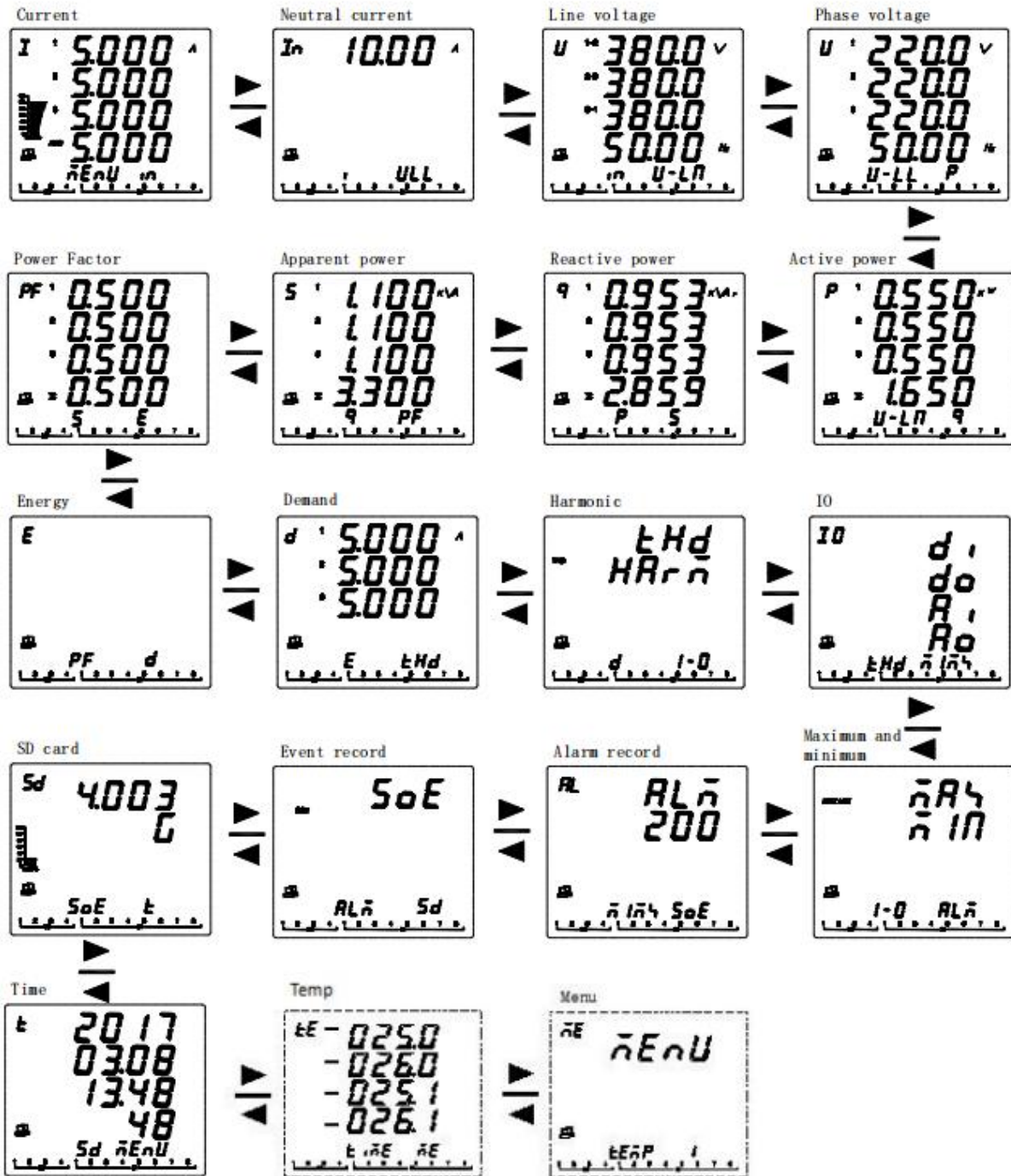
The power parameter overview: After the meter is powered on, the current is displayed. Press the left and right keys to switch the display to the following interface (some parameters need to press the enter key to enter the next level):



View energy: Press ◀▶ button in the main interface until the current measurement data display area shows E, then press ENTER, press ◀▶ button to switch the display: IMP (total absorbed active energy) ↔ EXP (total released active energy) ↔  EQL (total inductive reactive energy) ↔  EQC (capacitive reactive energy).

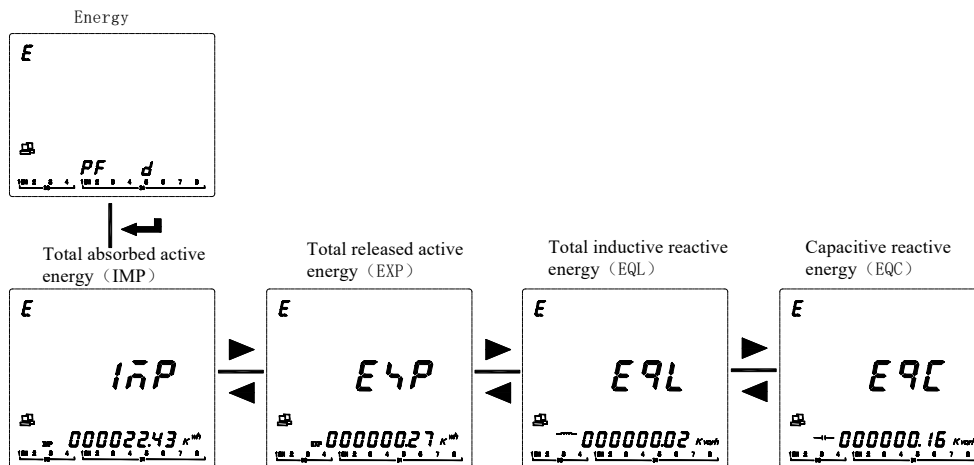

View demand: Press ◀▶ button on the main screen until the current measurement data display area shows d. The measurement data area displays the current demand of three-phase current and press the enter key. Press ◀▶ key to view the current demand of active power, the current demand of reactive power, the current demand of apparent power, the maximum demand of three-phase current and time of occurrence, and the maximum demand of three-phase power and time of occurrence.

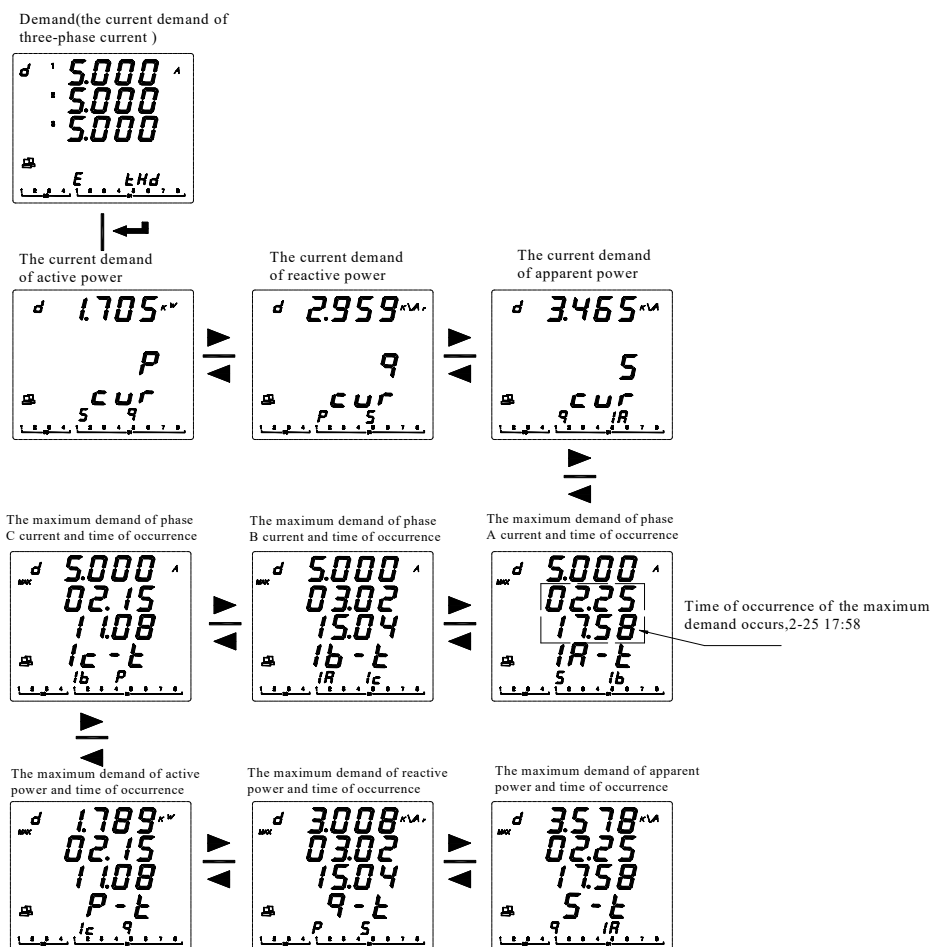

View harmonic (APM810 only): Press ◀▶ key on the main screen until the current measurement data display area shows THD, the measurement data area shows THD, HARM, and press the enter key. Press the ◀▶ key to view the total harmonic distortion of the

voltage, the total odd harmonic distortion of the voltage, the total even harmonic distortion of the voltage even, the total harmonic distortion of the current, the total odd harmonic distortion of the current, and the total even harmonic distortion of the current. After you press the enter key at the total harmonic distortion of voltage (or current) interface, you can view the subharmonics.

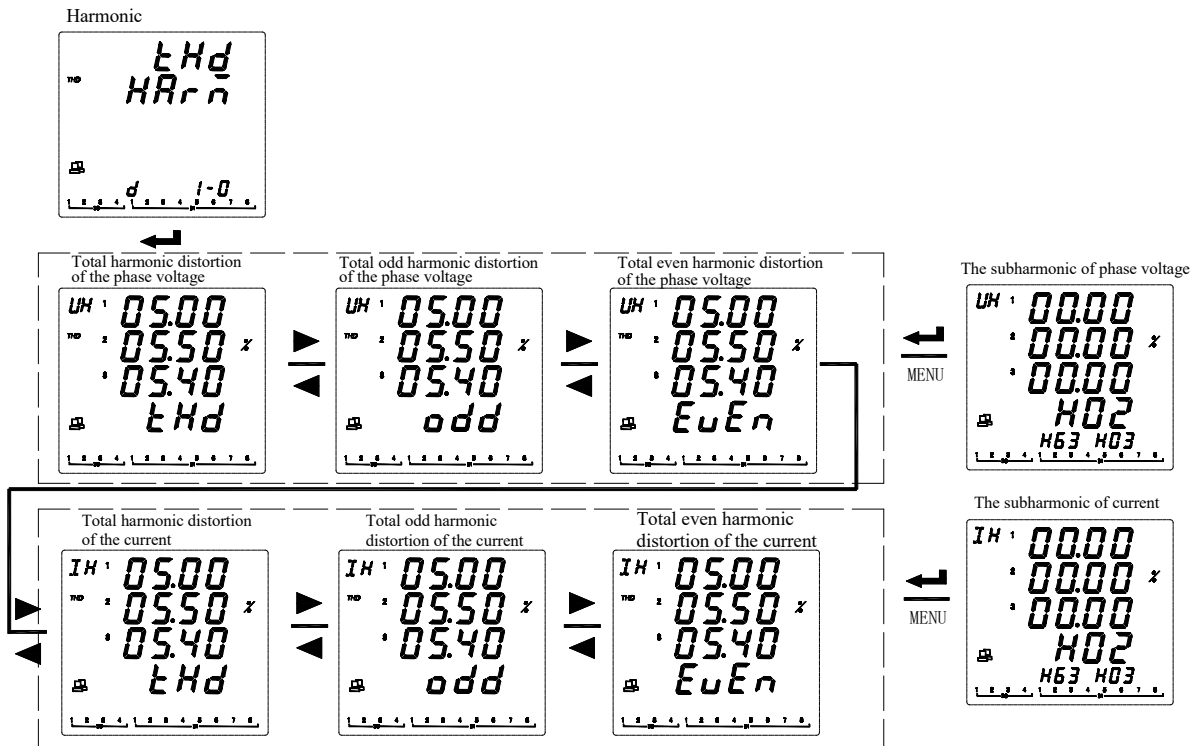

View IO (Input and output): Press ◀▶ key on the main screen until the current measurement data display area shows IO, and the measurement data area shows DI, DO, AI, AO, press enter. Press the ◀▶ keys to select the information to be viewed (DI: digital input, DO: digital output, AI: analog input, AO: analog output).

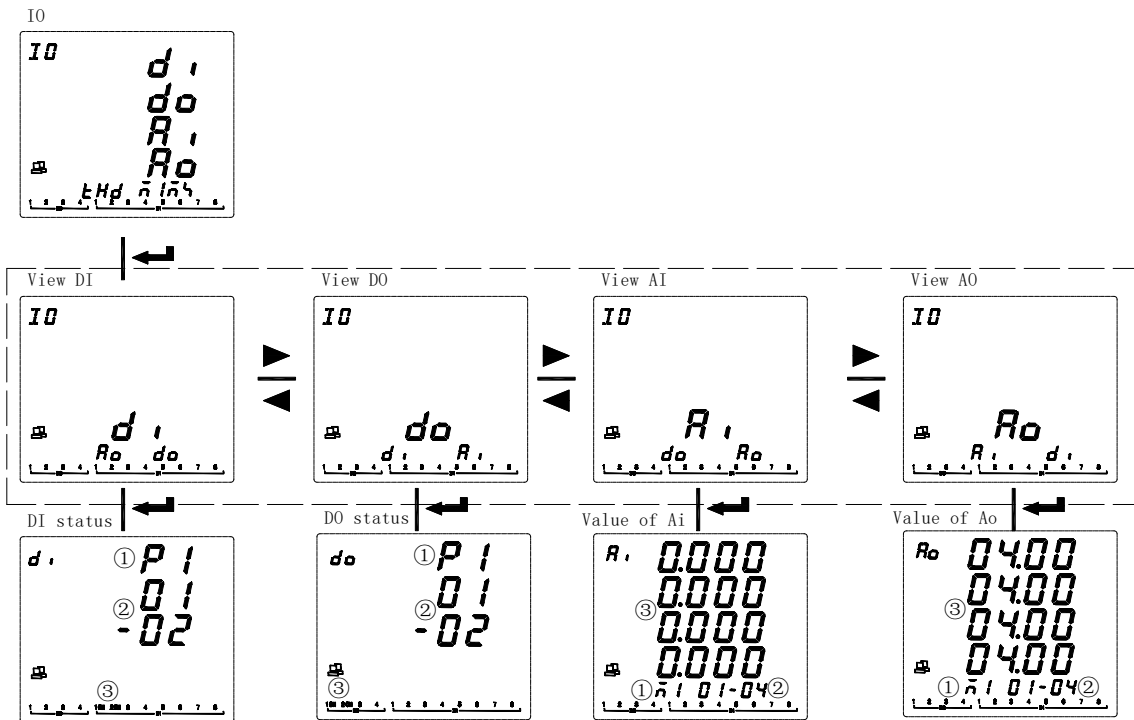

- ① P1:Main part; M1:Module 1 M2:Module 2, and so on.
- ② Take DI for example, DI1-DI2 status is indicated at ③,others is similar.
- ③ Indicate status or values of DI/DO/AI/AO.

View maximum and minimum values: Press ◀ key on the main screen until the current measurement data display area shows MAX MIN and press enter. Press ▶ key to select the extreme value record of the electric parameters (I, U, P, Q, S, PF, F, THD, etc.) to be viewed and press the Enter key. Press the ◀ key to view the current month's maximum value, the current month's minimum value, the previous month's maximum value, the previous month's minimum value, and the time of occurrence of the selected electrical parameter. When a month span occurs, the extreme value of this month is automatically deposited into the extreme value of the previous month.

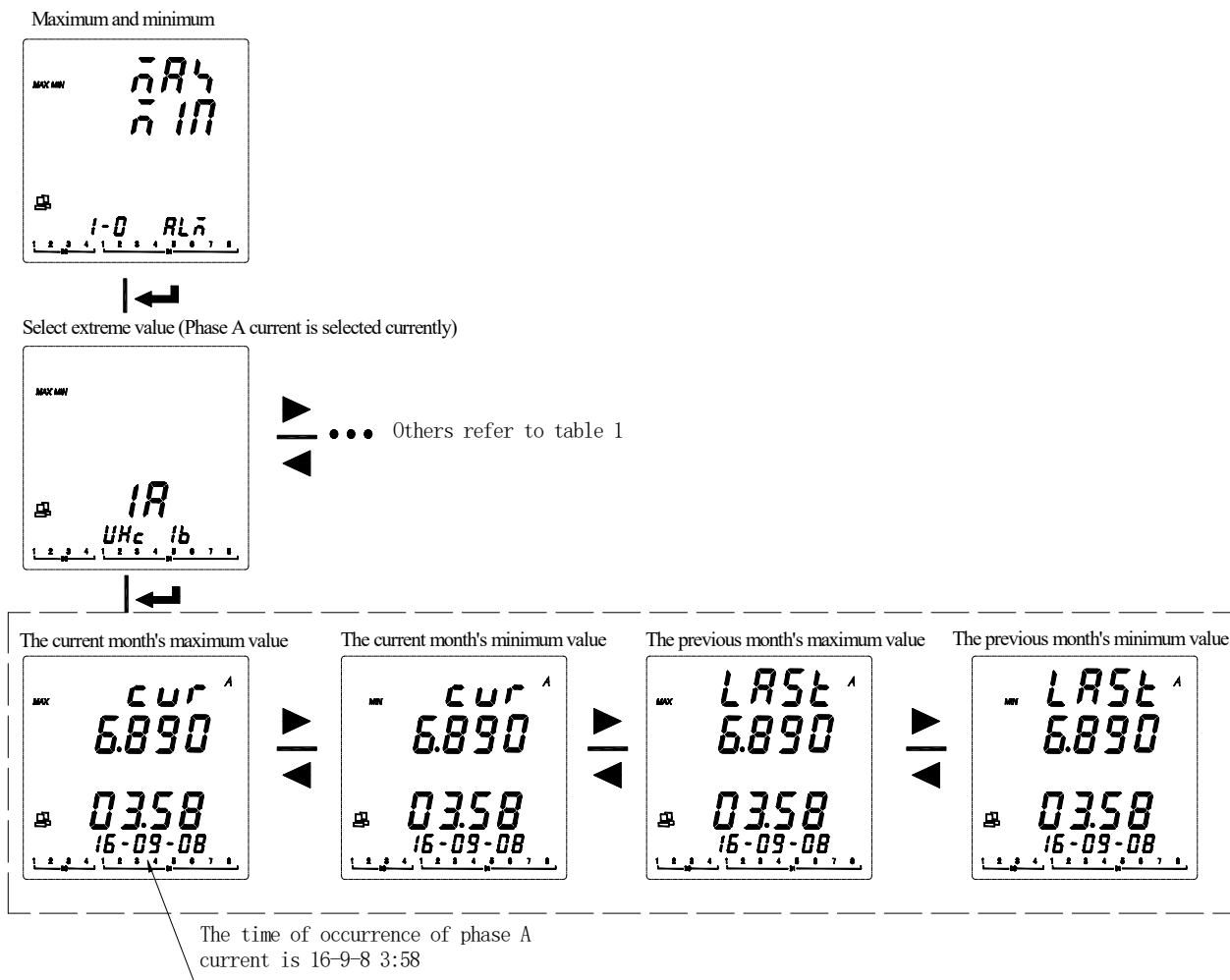

Table 1: Extreme Values and symbol description

Symbol	Instruction	Symbol	Instruction	Symbol	Instruction
IA	Phase A current	PT	Total active power	IHC	Total harmonic of Phase C current
IB	Phase B current	QA	Phase A reactive power	UHA	Total harmonic of Phase A voltage
IC	Phase C current	QB	Phase B reactive power	UHB	Total harmonic of Phase B voltage
IN	Neutral current	QC	Phase C reactive power	UHC	Total harmonic of Phase C voltage
IAV	Average current	QT	Total reactive power		
UA	Phase A voltage	SA	Phase A apparent power		
UB	Phase B voltage	SB	Phase B apparent power		
UC	Phase C voltage	SC	Phase C apparent power		
ULN (AVG)	Average phase voltage	ST	Total apparent power		
UAB	Phase AB line voltage	PFA	Phase A power factor		

UBC	Phase BC line voltage	PFB	Phase B power factor		
UCA	Phase CA line voltage	PFC	Phase C power factor		
ULL (AVG)	Average line voltage	PFT	Total power factor		
PA	Phase A active power	F	Frequency		
PB	Phase B active power	IHA	Total harmonic of Phase A current		
PC	Phase C active power	IHB	Total harmonic of Phase B current		

View the alarm: Press ◀▶ on the main screen until AL is displayed in the current measurement data display area, ALM is displayed in the measurement data area, and then press the Enter key. You can view the last 16 alarm records (Last Alm) in chronological order and view alarm records by alarm type.

APM series of meters can record 66 kinds of alarms, divided into 13 kinds of alarm categories (AT01 overcurrent, AT02 undercurrent, etc., see Table 2), each type of alarm includes a number of alarm subcategories (for example, the AT01 overcurrent alarm includes Phase A overcurrent, Phase B overcurrent, Phase C overcurrent, etc., see Table 2). Each alarm subclass can record up to 16 alarm records. When there are 16 or more alarm records, the principle of first in, first out is implemented. The newly generated alarm will automatically overwrite the oldest record. Each alarm record contains the alarm value, alarm group, alarm action (action or recovery), and alarm time. If an expansion module (including a TF card) is purchased, all alarm data will be automatically synchronized to the TF card for storage.

Note: The TF card cannot record all more than 16 alarm records that were simultaneously generated within 2 seconds.

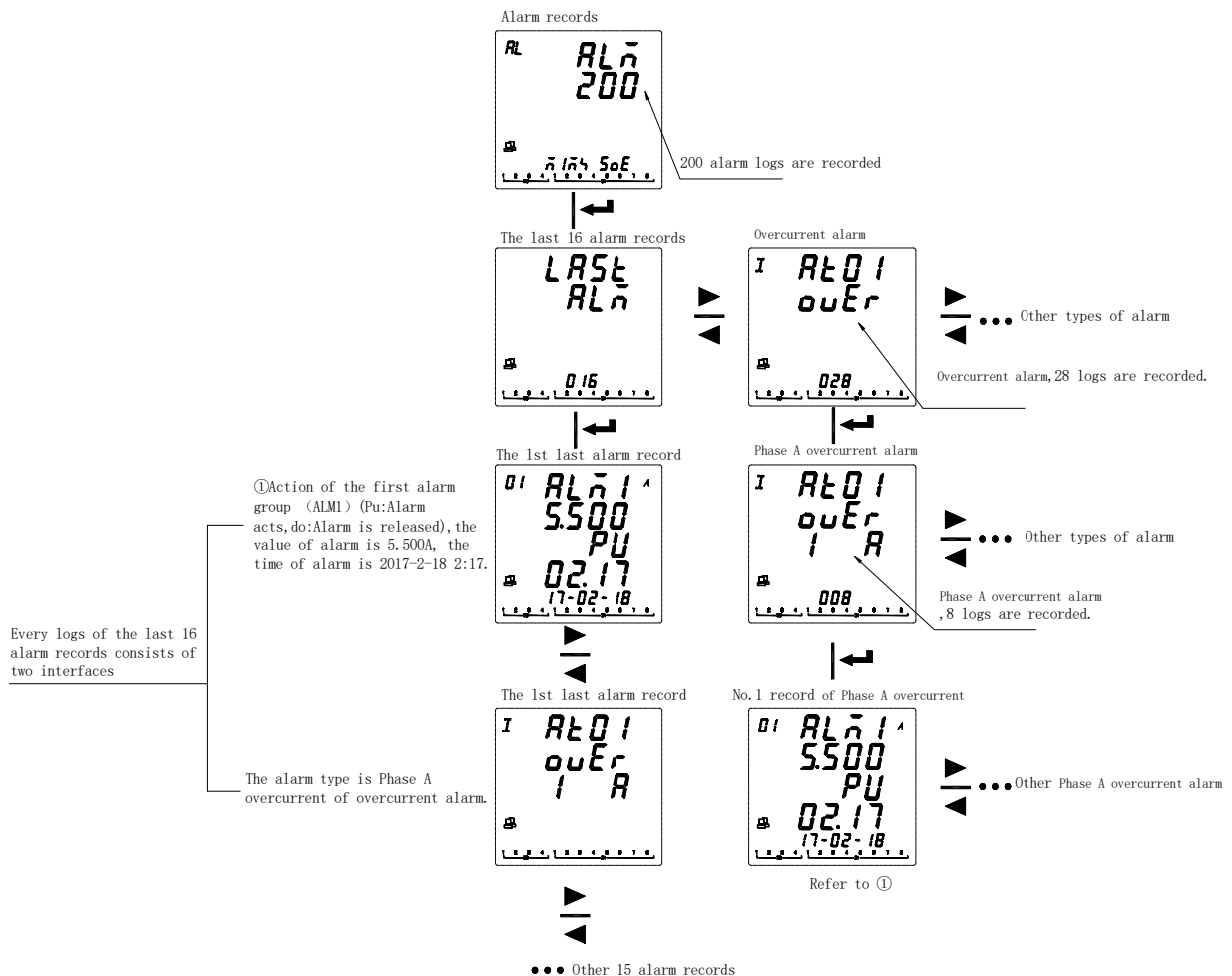
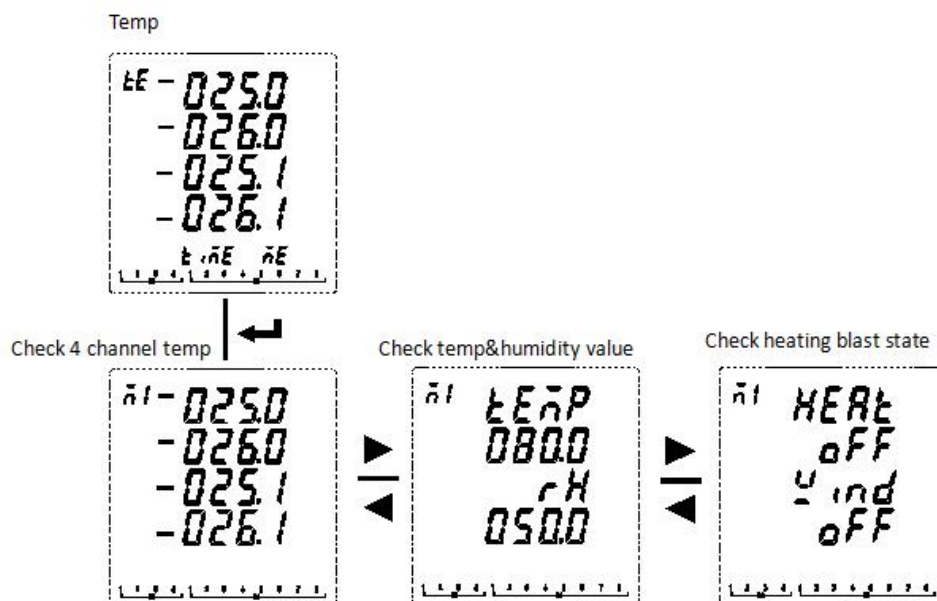

Table 2: Alarm classification description

Alarm categories	Alarm subcategories		Alarm content	Alarm communication code
	Symbol I	Symbol II		
AT01 (Overcurrent)	I Over	1 A	Phase A overcurrent	0
		2 B	Phase B overcurrent	1
		3 C	Phase C overcurrent	2
		4 MAX	Maximum overcurrent	3
		5 N	Neutral overcurrent	4
AT02 (Undercurrent)	I Unde	1 A	Phase A undercurrent	5
		2 B	Phase B undercurrent	6
		3 C	Phase C undercurrent	7
		4 MAX	Minimum undercurrent	8
		5 N	Neutral undercurrent I	9
AT03 (Overvoltage)	U Over	1 A	Phase A overvoltage	12
		2 B	Phase B overvoltage	13
		3 C	Phase C overvoltage	14
		4 L-N	Maximum phase overvoltage	15
		5 AB	Phase AB overvoltage	16
		6 BC	Phase BC overvoltage	17
		7 CA	Phase CA overvoltage	18
		8 L-L	Maximum line overvoltage	19
AT04 (Undervoltage)	U Unde	1 A	Phase A undervoltage	20
		2 B	Phase B undervoltage	21
		3 C	Phase C undervoltage	22
		4 L-N	Minimum phase undervoltage	23
		5 AB	Phase AB undervoltage	24
		6 BC	Phase BC undervoltage	25
		7 CA	Phase CA undervoltage	26
		8 L-L	Minimum line voltage undervoltage	27
AT05 (Overpower)	P Over	1 P	Total active overpower	31
		2 Q	Total reactive overpower	32
		3 S	Total apparent overpower	33
AT06 (Underpower)	P Unde	1 P	Total active underpower	34
		2 Q	Total reactive underpower	35
		3 S	Total apparent underpower	36
AT07 (Demand alarm)	Pd dMd	1 Over	Overdemand alarm of active power	59
		2 Unde	Underdemand alarm of active power	60
AT08 (Power factor alarm)	PF PF	1 Over	Total over power factor	37
		2 Unde	Total under power factor	38
AT09 (Total Harmonic Alarm)	THD	1 IA	Over THD of Phase A current	41
		2 IB	Over THD of Phase B current	42
		3 IC	Over THD of Phase C current	43
		4 UA	Over THD of phase A voltage	44
		5 UB	Over THD of phase B voltage	45
		6 UC	Over THD of phase C voltage	46
AT10 (Total Even	EVEN	1 IA	Over TEHD of Phase A current	47

Harmonic Alarm)		2 IB	Over TEHD of Phase B current	48
		3 IC	Over TEHD of Phase C current	49
		4 UA	Over TEHD of Phase A voltage	50
		5 UB	Over TEHD of Phase B voltage	51
		6 UC	Over TEHD of Phase C voltage	52
AT11 (Total odd harmonics Alarm)	Odd	1 IA	Over TOHD of Phase A current	53
		2 IB	Over TOHD of Phase B current	54
		3 IC	Over TOHD of Phase C current	55
		4 UA	Over TOHD of Phase A voltage	56
		5 UB	Over TOHD of Phase B voltage	57
		6 UC	Over TOHD of Phase C voltage	58
AT12	di	1 di1	DI1 ON/OFF	62
		2 di2	DI2 ON/OFF	63
		3 di3	DI3 ON/OFF	64
		4 di4	DI4 ON/OFF	65
AT13 (Other)	Oth	1 I-Ubl	Max unbalanced current	10
		2 U-Ubl L-N	Max unbalanced phase voltage	28
		3 U-Ubl L-L	Max unbalanced line voltage	29
		4 F Over	Over Frequency	39
		5 F Unde	Under Frequency	40
		6 I Loss	Current Loss	11
		7 U Loss	Voltage Loss	30
		8 PHA Rev	Phase Reversal	61
AT14(Temperature)	Temp	1	1 st way temperature	66
		2	2 nd way temperature	67
		3	3 rd way temperature	68
		4	4 th way temperature	69

To check the temperature and humidity: Press < ▶ > key in the main interface, until the current measurement data display area displays TE, the measurement data area displays temperature, then press < ENTER > key. You can check the four channel temperature. At the temperature interface press < ▶ > Key to check the temperature and humidity sensor value and the state of the heating blast.



View event record (SOE): When the DI/DO status is changed, event records can be generated. The main body can store up to 128 event records. If you purchased an expansion module (including a TF card), all event log data will be automatically synchronized to the TF card for storage.

Note: The TF card cannot record all more than 16 alarm records that were simultaneously generated within 2 seconds.

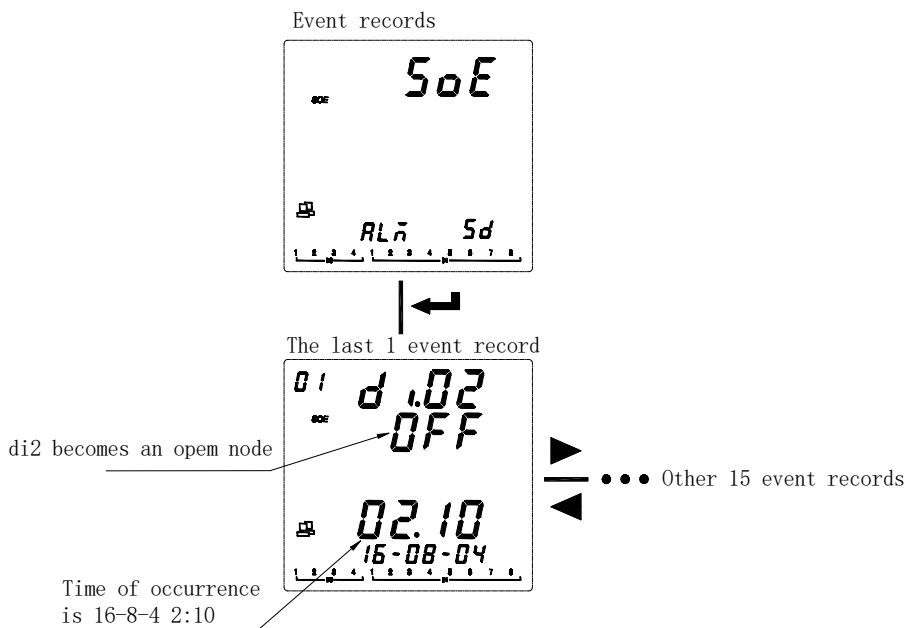

See the TF card data record: After power off, remove the TF card and use a card reader or other device to plug it into the computer for reading.

The data log files included in the TF card are: Alarm (Alarm data), Energy (Timed recording energy data), Harmonic (Harmonic data), Maintain (Basic parameter data), Record (Timed recording electrical parameter data), SOE (Event log data), APM800Config.ini (Parameter log file settings), Temperature (Temp&Humidity data) ReadMe.txt (Guide).

Note: If the system time is set incorrectly, the TF card will not be recognized.

① Alarm data: Open the Alarm folder. The folder contains subfolders named "Year_Month" (For example: 2018_02). The subfolder contains the .csv record file named "Alarm Type" (eg: Over THD. Csv), you can view the alarm data. The log file contains: date; time; alarm group; alarm type; alarm value; alarm status.

② View the timed energy record data: Open the Energy folder, and the folder contains the .csv record file (2018_02.csv) named "Year_Month" to view the timed energy record data. The log file contains: date; time; positive active energy; reverse active energy; inductive reactive energy; capacitive reactive energy; positive active energy in T1 period; positive active energy in T2 period; positive active energy in T3 period; positive active energy in T4 period.

Note: The meter records 1 time energy data (primary side) by default for 1 hour. It also includes the positive active energy in each time period. The time interval can be set. The time interval unit is Hour.

Symbol	Content	Symbol	Content
IMP	Positive active energy	IMP(T1)	Positive active energy in T1 period
EXP	Reverse active energy	IMP(T2)	Positive active energy in T2 period
EQL	Inductive reactive energy	IMP(T3)	Positive active energy in T3 period
EQC	Capacitive reactive energy	IMP(T4)	Positive active energy in T4 period

③ View harmonic data: Open the Harmonic folder, which contains subfolders named "Year_Month" (For example: 2018_03), and the subfolder contains a .csv log file named "Year_Month_Date" (eg :2018_03_31.csv), you can view harmonic data. The log file contains:

date; time; three-phase phase-separated voltage, current total harmonic value (maximum, minimum); three-phase phase-separated voltage, total odd current harmonic, total even harmonic value (maximum, minimum)); three-phase phase-separated voltage and current fractional harmonic values (maximum, minimum, recorded 2-63 harmonic data).

Note: The meter records 1 time harmonic data (primary side) by default for 1 minute, the time interval can be set, and the time interval unit is minute.

④View the main parameter change record: Open the Maintain folder, the folder contains the "Maintain.csv" log file, you can view the parameter change record. The log file contains: date; time; parameter type (such as: primary side voltage and current value; secondary side voltage and current value; 485 communication address and baud rate); new parameter value.

⑤View timed electrical parameter record data: Open the Record folder, which contains subfolders named "Year_Month" (eg 2018_03), and the subfolder contains the .csv log file named "Year_Month_Date" (Example: 2018_03_31.csv), you can view the timed electrical parameter record data. The log file is as follows:

Note: The meter records 1 time electric parameter data (primary side) by default for 1 minute, the time interval can be set, and the time interval unit is minute.

Symbol	Content	Symbol	Content	Symbol	Content
IA(A)	Phase A current	UBC(V)	Phase BC line voltage	PT(W)	Total active power
IB(A)	Phase B current	UCA(V)	Phase CA line voltage	QA(Var)	Phase A reactive power
IC(A)	Phase C current	U_LL_AVG(V)	Average line voltage	QB(Var)	Phase B reactive power
IN(A)	Neutral current	UA_UBL(%)	Unbalance of Phase A voltage	QC(Var)	Phase C reactive power
I_AVG(A)	Average current	UB_UBL(%)	Unbalance of Phase B voltage	QT(Var)	Total reactive power
IA_UBL(%)	Unbalance of Phase A current	UC_UBL(%)	Unbalance of Phase C voltage	SA(VA)	Phase A apparent power
IB_UBL(%)	Unbalance of Phase B current	U_LN_UBL(%)	Unbalance of phase voltage	SB(VA)	Phase B apparent power
IC_UBL(%)	Unbalance of Phase C current	UAB_UBL(%)	Unbalance of AB line voltage	SC(VA)	Phase C apparent power
I_UBL(%)	Unbalance of current	UBC_UBL(%)	Unbalance of BC line voltage	ST(VA)	Total apparent power
UA(V)	Phase A voltage	UCA_UBL(%)	Unbalance of CA line voltage	F(Hz)	Frequency
UB(V)	Phase B voltage	U_LL_UBL(%)	Unbalance of line voltage	PFA	Phase A power factor
UC(V)	Phase C voltage	PA(W)	Phase A active power	PFB	Phase B power factor
U_LN_AVG(V)	Average phase voltage	PB(W)	Phase B active power	PFC	Phase C power factor
UAB(V)	AB line voltage	PC(W)	Phase C active power	PF	Total power factor

⑥View event log data: Open the SOE folder, which contains the .csv log file named "Year_Month" (for example: 2018_03.csv) to view the event log data. The log file contains: date; time; DIDO serial number; action type.

⑦Check the Temperature and humidity data: open the Temperature folder, folder containing "year _ month _ date" named. CSV record file (such as :2020_03_31. CSV), you can see the Temperature and humidity data.The record file contains: date;Time;Temperature and humidity measurement;Maximum and minimum.

Note: The data in the TF card is read-only, and the file record data is excel. Please open it with Microsoft Office Excel07 version and above 07 version. If it is lower than Microsoft Office Excel07 version or WPS, there will be some data loss.

7.5 System Settings

To set up the APM series meter, follow the instructions below:

- ① Press ◀▶ at the measurement screen until Menu is selected and press ENTER.
- ② Press ◀▶ until Set is selected and press ENTER.
- ③ Enter your password. The default password is 0001 and the universal password is 0008.
- ④ Select the parameters to be modified.

Modify the parameters as follows:

- ① When a value or character is selected, flashing indicates that it can be modified.
- ② 1) For values that do not need to distinguish ones, tens, hundreds, thousands, use the ◀▶ keys to change the currently selected value.
2) To achieve the method to increase or decrease the value of ones, tens, hundreds, thousands, you need to press ◀ to select the bit that need to be modified, and press ▶ to change the value of the selected bit.
- ③ Press Enter to save the changes and move to the next area.
- ④ Press the SET button before saving, prompt for saving will appear. Press the left or right key to select yes/no. When you select yes, press Enter to save the setting parameters. When you select no, press Enter will not to save the setting parameters.

7.5.1 System Settings Overview (SET):

First level	Second level	Third level	Range	
Bus (communication)	BUS 1 (First way)	Addr	Address: 1-247	
		Baud	Baud rate: 1200,2400,4800,9600,19200,38400	
		Mode	Mode: None 1sp (No parity, 1 stop bit) None 2sp (No parity, 2 stop bits) Odd 1sp (Odd check, 1 stop bit) Even 1sp (Even parity, 1 stop bit)	
	BUS2	Same as BUS1	Extended RS485 module	
	DLT 645	Addr	645 Address: 0-999999999999	
	Profibus	Addr	Profibus Address: 1-127	
SYS (System)	Rto.i	I Pri	Primary rated current: 1A-32760A =Pri*Scale (See current ratio setting)	
		I Scal		
		I Sec	Secondary rated current rating: 1A, 5A	
		In Pri	Primary neutral rated current: 1A-32760A =Pri*Scal	
		In Scal		
		In Sec	Secondary neutral rated current rating: 1A, 5A	
	Rto.u	U Pri	Primary rated voltage: 100V-1200kV =Pri*Scal	
		U Scal		
		U Sec	Secondary rated voltage rating: 100V, 110V, 400V, 690V	
	Line		Wiring: 3P3W_3CT: Three-phase three-wire 3CT 3P3W_2CT: Three-phase three-wire 2CT 3P4W: Three-phase four-wire	
	nom	U.nom	Nominal value of secondary voltage, used to calculate voltage deviation	
		F.nom	Nominal value of frequency used to calculate frequency deviation.	

	Puls		Pulse constant: 0-9999, see system setup section
ALM (Alarm)	AL1		The first group of alarms: see the alarm setting section for details.
	AL2		The second group of alarms
dMd (Demand)	Wid		Window sliding time: 1, 2, 3, 5 minutes
	Pd		Period: 5-60 minutes
Ubl (Unbalance)	Meth		Calculation method of unbalance: Absolute (Absolute value algorithm) (The difference between the maximum value deviating from the average and average value) / average *100% Rated (Rated algorithm) If the average value of the denominator in the above equation is less than the rated value, the denominator is the rated value.
Di-o (Digital inputs and outputs)	DI	Init	Initial state: N-O (Normally open) / N-C (Normally closed)
	DO	Init	Initial state: N-O (Normally open) / N-C (Normally closed)
		TYPE	ALM1 (Associated with alarm 1, see DO setting) ALM2 (Associated with alarm 2, see DO setting) COM (Communication control)
		DLY	Effective when controlled by communication. When it is set to 0, it is the level control mode. If it is not 0, it is the pulse control mode. After the delay time is set, it will be disconnected. Unit: 1 second.
Ai-o (Analog inputs and outputs)	AI	TYPE	Input Type: 0-20mA, 4-20mA, 0-5V, 1-5V
		Dot	Decimal point: 0-3
		High	High value of display: 0-9999
		Low	Low value of display: 0-9999
	AO	TYPE	Output Type: 0-20mA, 4-20mA, 0-5V, 1-5V
		SEL	Select the corresponding signal, and see the analog output set.
		High	Corresponding value of high point of analog output (Primary value)
		Low	Corresponding value of low point of analog output (Primary value)
	ofs	Offset (Based on 16mA/4V)	
nET (Ethernet)	IP		IP address
	SUB		Subnet mask
	GATE		Gateway
	PORT		Port number: 1-9999
Time	Minute, second, year, month, day		See the time setting section
PASS (Password)	set		Password of parameter setting: 0-9999
	rst		Reset password: 0-9999
LCD (Backlight)			0: Always bright Non-zero: After delaying the setted value, the backlight goes off in units of seconds.
WHD (Temp&Humidity)	No X	H.dry	Heat to remove moisture, can set the temperature, Amount of hysteresis(Hys), delay (DLY).
		Heat	Heating up, can set the temperature, Amount of hysteresis(Hys), delay (DLY).
		Fanc	Air blast cooling, humidity can be set, Amount of hysteresis (Hys), delay (DLY).

Hysteresis: In the process of temperature and humidity control, the difference between the temperature or humidity value of the actuator

(heater or fan) when it starts working and the temperature or humidity value when it stops working is called hysteresis.

7.5.2 Communication settings

1. After entering setup mode (the same settings below), press ◀ until BUS is selected and press Enter.
2. Press the ▶ keys to select the communication parameters (bus1/bus2/DLT645/Profibus) and press the Enter key.
3. Set ADDR (communication address), range: 1-247 and press the Enter key.
4. Select bAUd (baud rate) and press the Enter key.
5. Select Mode (check mode and stop bit) and press the Enter key.
6. Press the SET button to return to the R485 BUS interface.

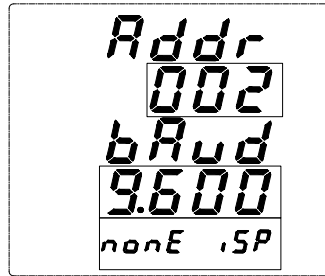

7.5.3 System setting (Current ratio)

1. Press ▶ until SYS is selected and press the Enter key.
2. Press ▶ until Rto.i is selected and press the Enter key.
3. Input the rated value of primary side current(I Pri) and press the Enter key.
4. Enter the ratio of primary side current (SCALE), optional *01, *10 times, used to set the primary side current greater than 9999A, the actual rated value of primary side current is Pri*SCAL, If you need to set the primary side current to 10000A, you can set Pri=1000, SCAL=10;
5. Select the value of rated secondary side current (I Sec) and press the Enter key.
6. Enter the the rated value of primary side (In Pri), the ratio of primary side (SCAL), and the rated value of secondary side (In Sec) for the neutral current. Refer to steps 3, 4, and 5.

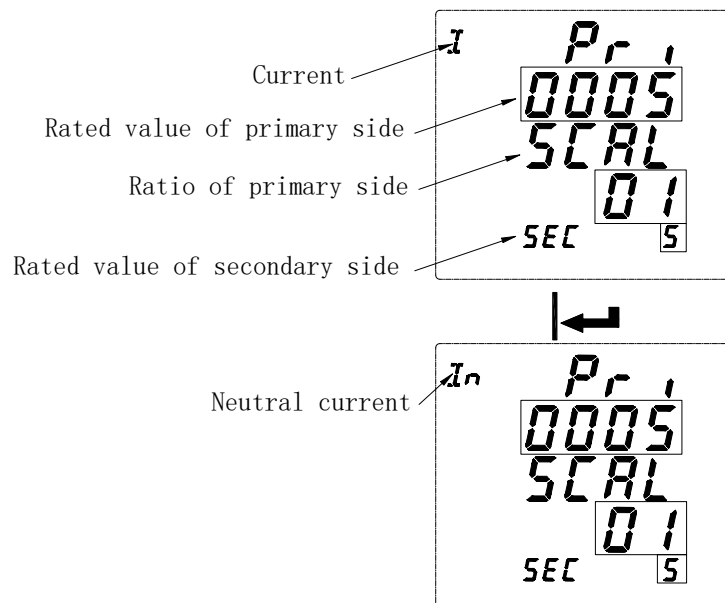

7.5.4 Voltage ratio setting refers to current ratio setting

For example: If the current input is connected by external CT and the rated value is 40A/5A, set the rated value of primary side current to 40A, the scale value to 1, and the rated value of secondary current to 5A. Neutral current setting is the same. If the voltage input is connected by external PT and the rated value is: 6000V/400V, then set the rated value of the primary voltage to 6000V, the scale value to 1, and the rated value of secondary voltage to 400V.

7.5.5 Pulse constant setting (Only APM801 can be set)

When the pulse constant is set to 0, the default is 8000 when the rated value of the secondary side current is 1A, and the default is 4000 when the rated value of the secondary side current is 5A. When the pulse constant is set to non-zero, the actual pulse constant is the setted value*100. For example, if the set value is 50, the actual pulse constant is 5000.

Note: ① The primary value must be greater than or equal to the secondary value.

② Only the APM801 can set the pulse constant.

7.5.6 Alarm Settings

1. Press ◀▶ until ALM is selected and press the Enter key.
2. Press ◀▶ key to select the alarm group (a total of two groups of alarms) and press the Enter key.
3. Press the ◀▶ keys to select the alarm category (Refer to Table 2 of 7.4 Alarm View) and press the Enter key.
4. Under the alarm category, select the alarm subclass (Refer to Table 2 of 7.4 Alarm View) and press Enter key.
5. Enable selected alarm type (ENABLE or disable selected alarm type (DISABLE) and press the enter key.
6. Input the value of alarm action (primary value). For some parameters, you can set the negative value. Press the ◀▶ key at the same time to switch the positive and negative signs and press the enter key.
7. Enter the delay time of alarm action and press the enter key.
8. Enter the recovery value of alarm (primary value) and press the enter key.
9. Enter the delay time of alarm recovery and press the enter key.
10. Enable alarm in zero value(low value of alarm is effective) and press the enter key.
11. Return to the third step and make other alarm settings.
12. Press the SET button to return.

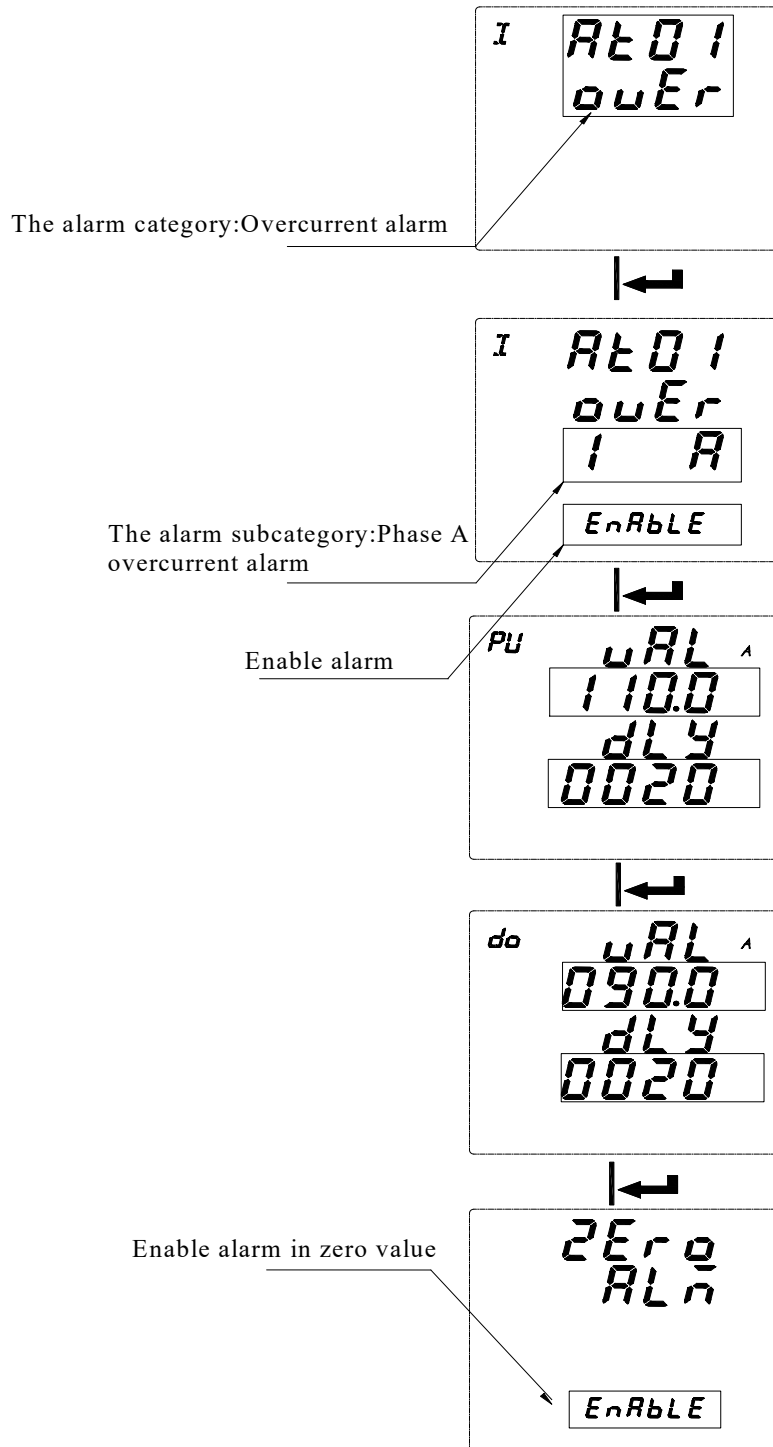

The parameter symbol description for settings

	Indication area symbol	Symbols of display area	Range
Enable settings			ENABLE,DISABLE
Parameter settings	PU (Pick Up)	VAL (Alarm value)	0-9999
		dLy (Alarm delay value, accurate to second)	0-9999
	Do(Drop Out)	VAL (Recovery value)	0-9999
		dLy (Recovery delay value, accurate to second)	0-9999
			ZERO ALM (Enable or disable zero alarm)

Note: For high alarm types, the recovered value must be less than the alarm value. For low alarm types, the recovered value must be greater than the alarm value.

The following is a schematic of how the meter handles alarm parameters.

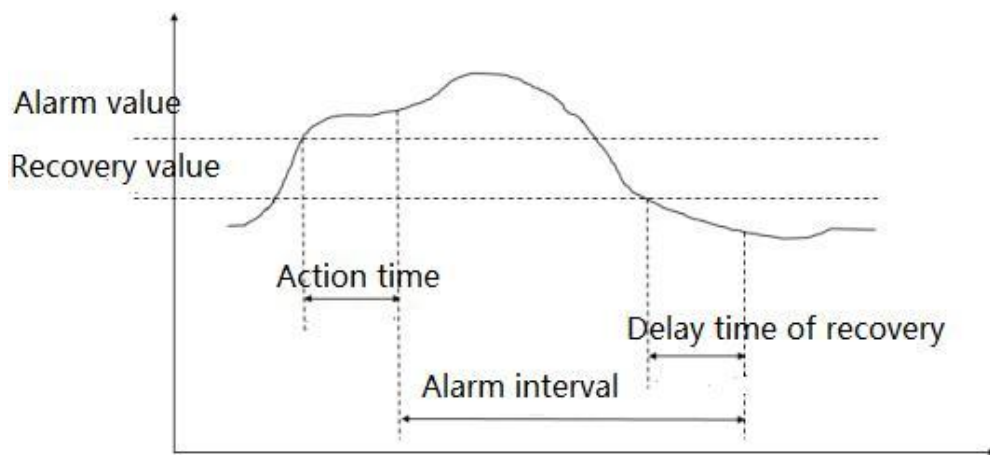

Alarm description:

The meter has two groups of alarms. Each group of alarms can detect a variety of alarm conditions, including changes in the inputs of the electronic parameters, phase loss, reverse phase sequence, unbalance, and harmonics. The switch input and reverse phase sequence only need to set the enable bit, and other alarms need to set the alarm condition.

7.5.7 Alarm Type Description

7.5.7.1 Electric parameter alarm

Overcurrent: Zero alarm setting does not apply to overcurrent alarm. When the single phase current is greater than or equal to the action value and meets the set action delay time, the single phase overcurrent alarm starts; when the single phase current is lower than the set recovered value and meets the delay time. The single phase overcurrent alarm is released.

Undercurrent: When the single phase current is lower than or equal to the action value and meets the set action delay time, the single phase undercurrent alarm starts; when the single phase current is greater than the recovered value and meets the delay time, the single phase undercurrent alarm is released.

Note: When undercurrent alarm and zero alarm is enabled, single phase current is equal to 0, the alarm is valid; when undercurrent is enabled and zero alarm is forbidden, when single phase current is equal to 0, the alarm is invalid.

7.5.7.2 Phase current loss alarm

When any current (not all current) is equal to or lower than the action value and meets the delay time, phase A current loss alarm occurs; and when any of the following conditions occurs, the alarm is released:

The three-phase current is greater than the recovered value and meets the delay time

The three-phase current is lower than the phase loss action value.

7.5.7.3 Reverse phase sequence alarm:

The values of action and recovery and delay time are not applicable to the reverse phase sequence alarm. When the phase sequence is not ABC normal phase sequence, an inverse phase sequence alarm is generated.

7.5.7.4 DI alarm

When the DI state changes from the initial state, an alarm is generated.

Examples are as follows:

Set Phase A overcurrent alarm of the first group of alarm enabled.

Action value: The action value is a primary value. For example, if the alarm value is set to 5.500A, when Phase A current value exceeds 5.500A, the alarm condition is triggered and the timer starts.

Action delay time: When the alarm condition is triggered, if Phase A current value exceeds 5.500A, an alarm record will be generated after the setted delay time (accurate to the second), Alarm group (alarm 1), alarm type (Phase A overcurrent), alarm time (eg: 2017-5-12 14:15:20) will be recorded. If DO is associated with this alarm, the DO acts (see DO settings).

Recovered value: The recovered value is a primary value. For example, if the recovered value is set to 5.400A, after Phase A overcurrent alarm has occurred, when Phase A current value is lower than 5.400A, the released alarm condition is triggered and the timer starts. .

Recovered delay time: When the triggered alarm condition is released, if Phase A current value has been lower than 5.400A, the released alarm record will be generated after the setted delay time (accurate to second), and the alarm group (Alarm1), alarm type (Phase A overcurrent), the released alarm time (eg 2017-5-12 14:17:20) will be recorded. If DO is associated with this alarm, the DO returns to its initial state. It can be calculated that the alarm duration is 2 minutes.

Note: The alarm is invalid when both the action value and the recovered value are zero.

7.5.8 Demand setting

1. Press ◀▶ until you select dMd and press the Enter key.
2. Set the window time (Wid) (1, 2, 3, 5) and press the Enter key.
3. Set the demand period (Pd) (1-60), which must be set to an integral multiple of the sliding window time and press the Enter key.
4. Press the SET button to return.

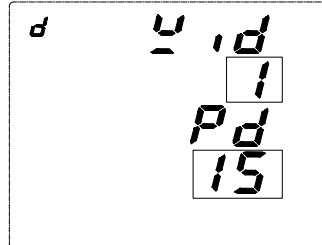

Demand calculation method:

APM series meters use the sliding window method to calculate the demand. In the sliding window calculation cycle, select a calculation period (Period) and a sliding window (Width). The calculation cycle of sliding window must be divided equally. For example, three 5-minute sliding windows (Wid = 5, Pd = 15) are set in a 15 minute calculation cycle. Refresh the current demand at the end of each sliding window. The schematic diagram is as follows:

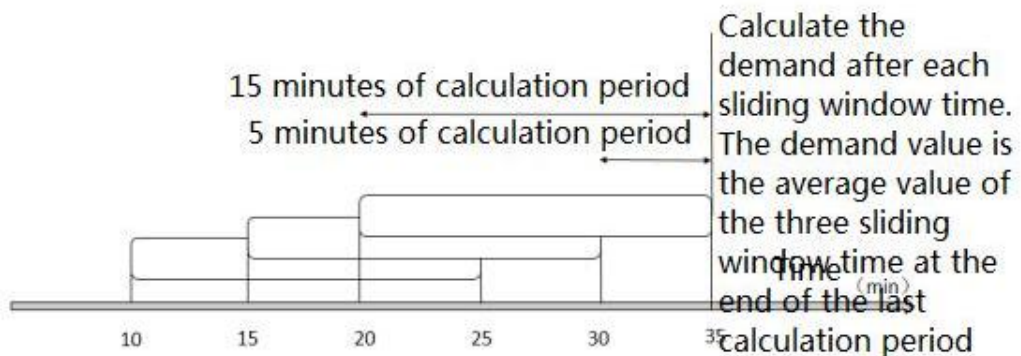

7.5.9 do settings

1. Press ◀ until dio is selected and press the Enter key.
2. Press ▶ until do is selected and press the Enter key.
3. Press the ◀▶ keys to select the do number (each main part contains 2 DO outputs and each MD82LOG module adds 2 DO outputs) and press the Enter key.
4. Press the ◀▶ keys to select Normally Open (N-O) or Normally Closed (N-C) and press the Enter key.
5. Press ◀▶ key to select the do output control mode. ALM1 (alarm group 1) and ALM2 (alarm group 2) are the alarm controls, and COM is the communication control. Press the Enter key.
6. 1) If you select the alarm (ALM1 or ALM2) control, press ◀▶ key to select the alarm category, press the Enter key. Select the alarm subclass, press the Enter key. Select whether to enable, press the Enter key. A DO can select multiple alarms for combined alarms.
2) If communication (COM) control is selected, modify the delay (DLY) time ranged 0-9999, unit 1 second. When it is set to 0, it is a level control. When it is not 0, it is a pulse mode control, and it is disconnected after the delay time is set.
7. Press the SET button to return.

Note: ① When the output control mode of do1 is selected as ALM (ALM1 or ALM2), and is not associated (DISABLE) with any alarm of ALM or associated with all alarms (ENABLE), When any alarm of this group (ALM1 or ALM2) is generated, do1 will act.

② When the output control mode of do1 is selected as ALM (ALM1 or ALM2) and associated (ENABLE) with Phase A overcurrent alarm and Phase A overpower alarm and not associated (DISABLE) with the other alarms. After the setting is completed, do1 acts when Phase A overcurrent or Phase A overpower alarm occurs.

③ Before selecting the alarm type associated with do, make sure that the alarm type is enabled in the alarm setting. If it is not enabled, the do does not act when this alarm condition occurs.

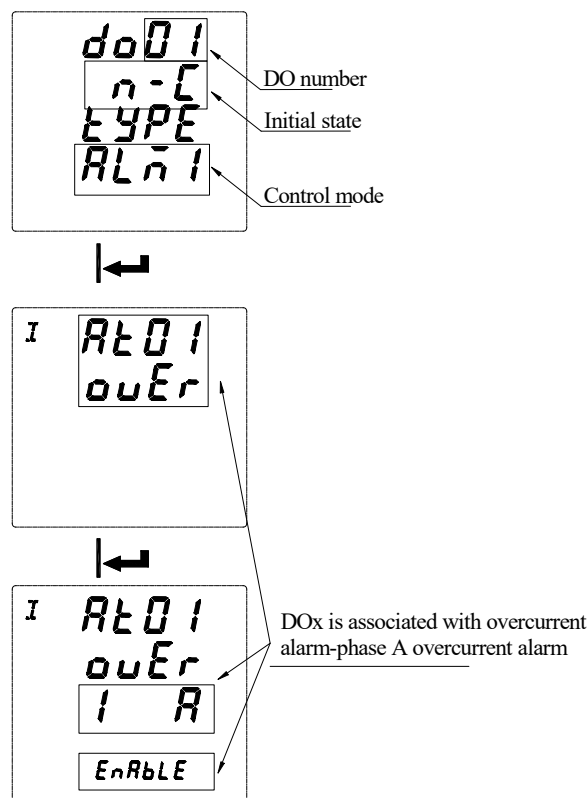

7.5.10 Analog input setting (valid with analog module)

1. Press **◀▶** until Aio is selected and press the Enter key.
2. Press **◀▶** until Ai is selected and press the Enter key.
3. Press **◀▶** until the Ai channel to be modified is selected and press the Enter key.
4. Select the input type (make sure the input type is current input or voltage input, current input can choose 0-20mA, 4-20mA, voltage input can choose 0-5V, 1-5V). Press the Enter key.
5. Select the decimal point of display and press the Enter key.
6. Set the high value of the signal input corresponding to displayed value and press the Enter key.
7. Set the low value of the signal input corresponding to displayed value and press the Enter key.
8. Press the SET button to return.

For example: Ai1 is set to 4-20mA input and the decimal point is set to 1. The displayed value of high point of is set to 1000 and the displayed value of low point is set to 0. When the Ai1 signal input is 20mA, the displayed value is 100.0. When the signal input is 4mA, the displayed value is 0. When the signal input is 12mA, the displayed value is 50.0.

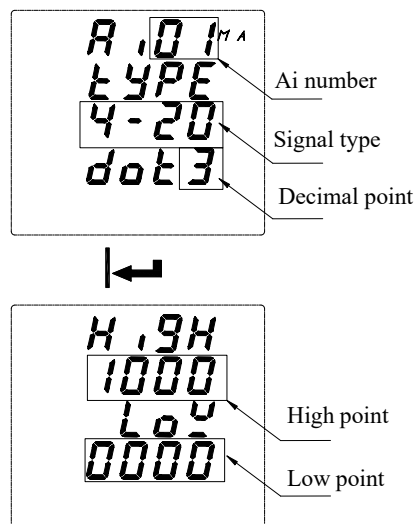

7.5.11 Analog output setting (Valid with analog module)

1. Press **◀▶** until Aio is selected and press the Enter key.
2. Press **◀▶** until Ao is selected and press the Enter key.
3. Press **◀▶** until the Ao channel to be modified is selected and press the Enter key.
4. Select the output type and press the Enter key.
5. Select the output corresponding signal (see Table 3) and press the Enter key.
6. Set the actual value of high point of the output corresponding to the signal and press the Enter key.
7. Set the actual value of low point of the output corresponding to the signal and press the Enter key.
8. Output offset, as a percentage of the reference value of 16mA (current output) or 4V (voltage output) and press the Enter key.
9. Press the SET button to return.

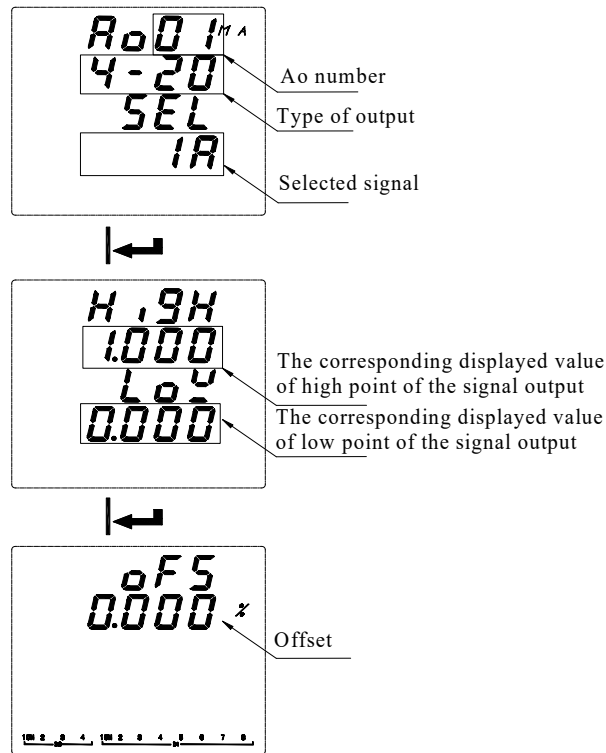

Table 3: Output Signals

No.	Symbol	Instruction	No.	Symbol	Instruction
0	IA	Phase A current	13	QA	Phase A reactive power
1	IB	Phase B current	14	QB	Phase B reactive power
2	IC	Phase C current	15	QC	Phase C reactive power
3	UA	Phase A voltage	16	QT	Total reactive power
4	UB	Phase B voltage	17	SA	Phase A apparent power
5	UC	Phase C voltage	18	SB	Phase B apparent power
6	UAB	Phase AB line voltage	19	SC	Phase C apparent power
7	UBC	Phase BC line voltage	20	ST	Total apparent power
8	UCA	Phase CA line voltage	21	PFA	Phase A power factor
9	PA	Phase A active power	22	PFB	Phase B power factor
10	PB	Phase B active power	23	PFC	Phase C power factor
11	PC	Phase C active power	24	PF	Total power factor
12	PT	Total active power	25	F	Frequency

For example:

When Ao1 is set to 4-20mA output, the signal is selected as IA (Phase A current), the corresponding signal of output high point is 5.000A, and the corresponding signal of output low point is 0.000A. When Phase A current value is 5A, Ao1 output is 20mA; when Phase A current value is 0A, Ao1 output is 4mA; when Phase A current value is 2.5A, Ao1 output is 12mA. If the actual output is 3.99mA at 0A, then the offset can be set to $(4-3.99)/16 = 0.062\%$ to make the zero output be 4mA.

7.5.12 Time setting

1. Press ◀▶ until Time is selected and press the Enter key.
2. Set hour (H), press the Enter key.
3. Set minute (M), press the Enter key.
4. Set second (S), press the Enter key.
5. Set year and press the Enter key.
6. Set month and press the Enter key.
7. Set day and press the Enter key.
8. Press the SET button to return.

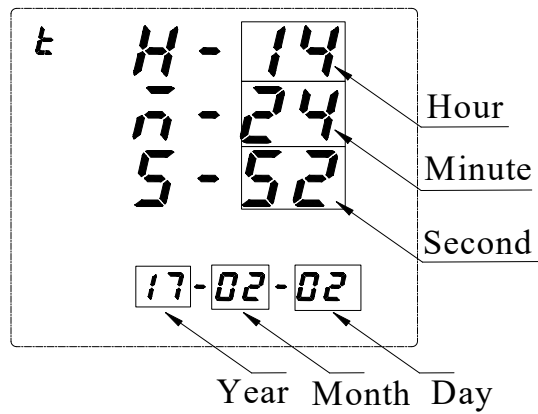

7.5.13 Network settings

1. Press ◀▶ until NET is selected and press the Enter key.
2. Enter the IP address and press the Enter key.
3. Enter the Subnet Mask (SUB) address and press the Enter key.
4. Enter the gateway address (GAT) and press the Enter key.
5. Enter the port address and press the Enter key.
6. Set the acquisition mode of IP address, MANU for manual acquisition, DHCP for automatic acquisition, press the Enter key.
7. Press the SET button to return.

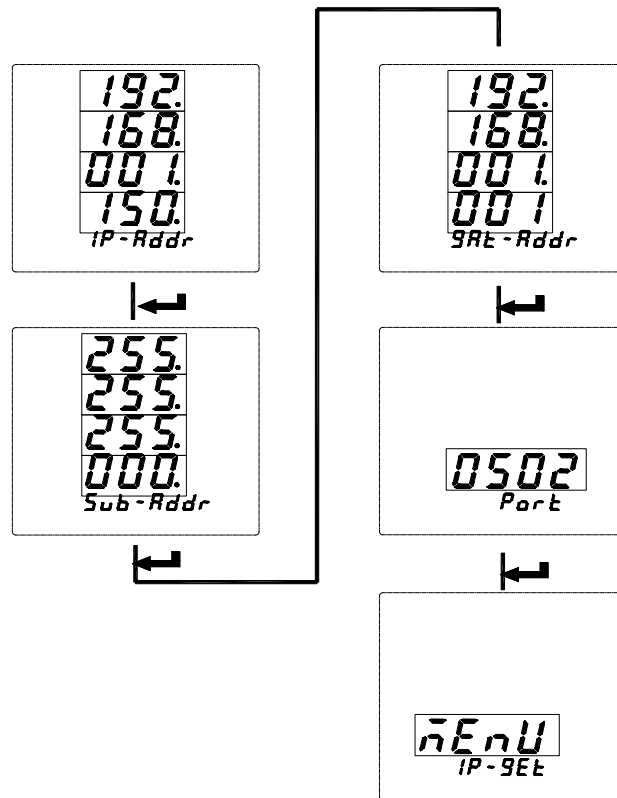

7.5.14 Setting of temp&humidity controlling

1. Press < ▶ > Key until WHD is selected, press < ENTER > key.
2. Input temperature and humidity channel to modify, press < ENTER > key.
3. Input the humidity to heat to dehumidify, press < ENTER > key.
4. Input amount of hysteresis to heat to dehumidify, press < ENTER > key.
5. Input alarm delay time of heating to dehumidify, press < ENTER > key.
6. Input temp to heating up, press < ENTER > key.
7. Input amount of hysteresis to heating up, press < ENTER > key.
8. Input alarm delay time of heating up, press < ENTER > key.
9. Input temp of air blast cooling, press < ENTER > key.
10. Input amount of hysteresis to air blast cooling, press < ENTER > key.
11. Input alarm delay time of air blast cooling, press < ENTER > key.

Note: Actual temperature > blowing air cooling value, open the blowing air;

Actual temperature < heating up value, open heating;

Actual humidity > heating dehumidification value, turn on heating.

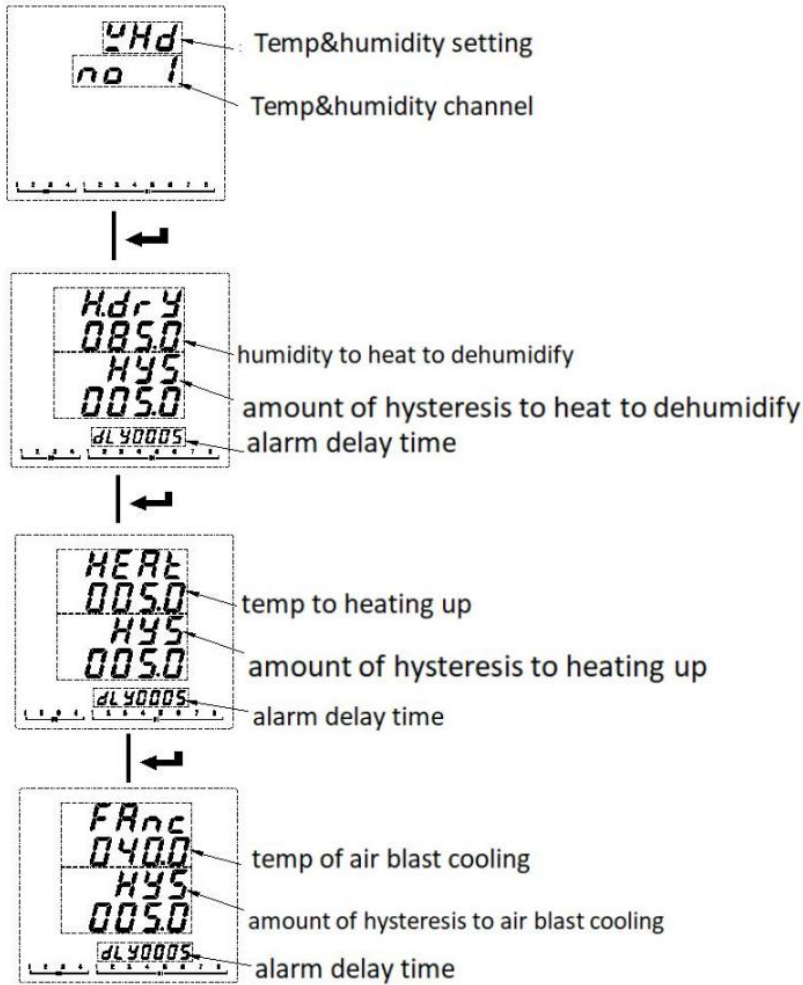

7.5.15 Recording configuration of TF card

1. Insert the TF card into the computer, find the corresponding drive letter and open it.
2. Double-click to open APM800Config.ini.
3. [INTERVAL] is a configuration area of sampling interval.

Parameter (minute), indicates the recording interval of electrical parameter in minutes and range (1-30).

Energy (hour), indicates the recording interval of energy in hours and range (1-12).

[PARAMETER] is the configuration area to record the electrical parameter. For example: IA=1 means to record Phase A current, IA=0 means not to record Phase A current.

[ENERGY] is the configuration area to record energy configuration. For example: IMP = 1 means to record absorbed active energy, and IMP = 0 means not to record absorbed active energy.

4. Save after configuration is complete.

7.6 Resetting data

In order to reset the data of APM series meter, please follow the instructions below:

- ① Press \blacktriangleleft at the measurement screen until Mune is selected and press the ENTER key.
- ② Press \blacktriangleleft until Rst is selected and press the ENTER key.
- ③ Enter your password. The default password is 0001 and the universal password is 0008.
- ④ Select the data to be reset and press the ENTER key. Refer to the following table.

⑤ Press left or right key to select yes to clear the corresponding data, and select no to cancel.

Symbol	Instruction
E	Clear energy
dMd	Clear demand
ALM	Clear alarm records
SOE	Clear event records
MIMX	Clear maximum and minimum
SD	Format TF card

The following is an example of clearing energy:

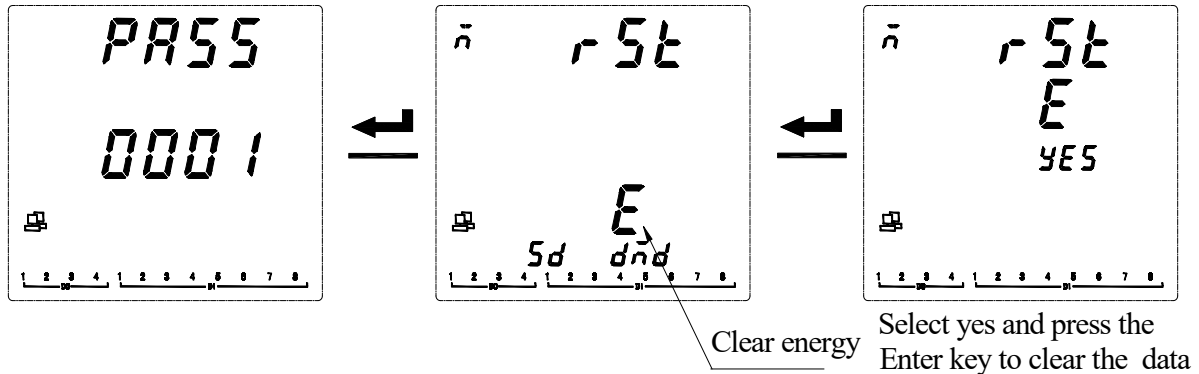

8. Modbus Communication instructions

8.1 Introduction

The APM series network power meter communication uses the MODBUS-RTU communication protocol. The MODBUS protocol defines the check code and data sequence in detail. These are the necessary contents for specific data exchange.

The first communication supports 0x03 (read holding register), 0x16 (write multiple registers), 0x01 (read coil status), 0x02 (read input status), 0x05 (write single coil) function code.

If the second communication or Ethernet communication (MODBUS-TCP) is extended, only the 0x03 (read holding register) function code is supported.

8.2 Communication Address Table

Register	Description	unit	Data Type	Parameters
0	Meter address(COMM1)		Int16 (RW)	Range :1-247
1	Baud rate(COMM1)		Int16 (RW)	0: 38400 1: 19200 2: 9600(default) 3: 4800 4: 2400 5: 1200
2	Parity(COMM1)		Int16 (RW)	0: None Parity with one stop bit(default) 1: None Parity with two stop bits 2: Odd Parity with one stop bit 3: Even Parity with one stop bit
3	System Type		Int16 (RW)	Lower 7 bit: 0:3P3W_2CT, 1:3P4W, 2:3P3W_3CT

4	Nominal Secondary Current		Int16 (RW)	1A or 5A
5	Nominal Secondary Voltage L-L		Int16 (RW)	100V、110V、400V、690V
6	Nominal Primary Current	1A	Int16 (RW)	0-32760A
7-8	Nominal Primary Voltage L-L	1V	Int32 (RW)	0-1200KV
	Meter address(COMM2)			
10	Baud rate(COMM2,slave)		Int16 (RW)	0: 38400 1: 19200 2: 9600 3: 4800 4: 2400 5: 1200
11	Parity(COMM2,slave)		Int16 (RW)	0: None Parity with one stop bit 1: None Parity with two stop bits 2: Odd Parity with one stop bit 3: Even Parity with one stop bit
13	Neutral current secondary side rating		Int16 (RW)	1A or 5A
14	Neutral current primary side rating	1A	Int16 (RW)	1A-32760A
15	Pulse constant	100	Int16 (RW)	0-9999(APM801 is valid) (When it is 0, default value is used, 1A: 8000, 5A: 4000; When it is not 0, pulse constant = register value *100)
16	Unbalance algorithm		Int16 (RW)	Unbalance algorithm(0: Rated, 1: Absolute)
18	Profibus address		Int16 (RW)	1-127
20	Year		Int16 (RW)	0-99
21	Month		Int16 (RW)	1-12
22	Day		Int16 (RW)	1-31
23	Hour		Int16 (RW)	0-23
24	Minute		Int16 (RW)	0-59
25	Second		Int16 (RW)	0-59
29	Enable change parameter of Ethernet from RS485 Port		Int16 (RW)	code: 0XABCD
30-31	IP Address		Int32 (RW)	Sample: 192.168.3.8 ADDR 30: C0A8H ADDR 31: 0308H
32-33	Subnet Mask		Int32 (RW)	Sample: 255.255.255.0 ADDR 32: FFFFH; ADDR 33: FF00H
34-35	Gateway		Int32 (RW)	Sample: 192.168.3.1 ADDR 34: C0A8H; ADDR 35: 0301H
36	Port Number		Int16 (RW)	0-9999
37	IP address allocation		Int16 (RW)	0: Manual; 1: Automatic (DHCP)
38	The code for Save the parameter of Ethernet		Int16 (RW)	code: 0XABCD
40	SD Storage State		Int16 (RO)	0,0x11: No SD Card 0x22: Bad SD Card

				0x33: SD work well 0x44: Full storage 0x55: Formating 0x66: Error in Configuration File
41	SD Total capacity	1M	Int16 (RO)	Unit : Megabytes
42	SD Residual capacity	1M	Int16 (RO)	Unit : Megabytes
61	Nominal voltage	0.1V	Int16 (RO)	Secondary side nominal voltage for calculating voltage deviation
62	Nominal frequency	0.01Hz	Int16 (RO)	Nominal frequency used to calculate frequency deviation
120	Blast cooling value (Module 1)	0.1°C	Int16 (RW)	0-9999
121	Blast cooling hysteresis	0.1°C	Int16 (RW)	0-9999
122	Blast cooling delay	1s	Int16 (RW)	0-9999
123	Heating up value	0.1°C	Int16 (RW)	0-9999
124	Heating up hysteresis	0.1°C	Int16 (RW)	0-9999
125	Heating up delay	1s	Int16 (RW)	0-9999
126	Heat dehumidification value	0.1%	Int16 (RW)	0-9999
127	Heat dehumidification hysteresis	0.1%	Int16 (RW)	0-9999
128	Hysteresis delay	1s	Int16 (RW)	0-9999
242	Neutral current,	0.001A	Int16 (RO)	Secondary
243	Voltage A-N	0.1	Int16 (RO)	Secondary
244	Voltage B-N	0.1	Int16 (RO)	Secondary
245	Voltage C-N	0.1	Int16 (RO)	Secondary
246	Voltage A-B	0.1	Int16 (RO)	Secondary
247	Voltage B-C	0.1	Int16 (RO)	Secondary
248	Voltage C-A	0.1	Int16 (RO)	Secondary
249	Current, Phase A	0.001	Int16 (RO)	Secondary
250	Current, Phase B	0.001	Int16 (RO)	Secondary
251	Current, Phase C	0.001	Int16 (RO)	Secondary
252	Nominal Frequency	0.01Hz	Int16 (RO)	
253-254	Active Power, Phase A	0.01W	Int32 (RO)	Secondary
255-256	Active Power, Phase B	0.01W	Int32 (RO)	Secondary
257-258	Active Power, Phase C	0.01W	Int32 (RO)	Secondary
259-260	Active Power, Total	0.01W	Int32 (RO)	Secondary
261-262	Reactive Power, Phase A	0.01Var	Int32 (RO)	Secondary
263-264	Reactive Power, Phase B	0.01Var	Int32 (RO)	Secondary
265-266	Reactive Power, Phase C	0.01Var	Int32 (RO)	Secondary
267-268	Reactive Power, Total	0.01Var	Int32 (RO)	Secondary
269-270	Real Power, Phase A	0.01VA	Int32 (RO)	Secondary
271-272	Real Power, Phase B	0.01VA	Int32 (RO)	Secondary
273-274	Real Power, Phase C	0.01VA	Int32 (RO)	Secondary
275-276	Real Power, Total	0.01VA	Int32 (RO)	Secondary
277	Active Power Factor, Phase A	0.001	Int16 (RO)	Secondary
278	Active Power Factor, Phase B	0.001	Int16 (RO)	Secondary
279	Active Power Factor, Phase C	0.001	Int16 (RO)	Secondary
280	Active Power Factor, Total	0.001	Int16 (RO)	Secondary

300-301	Active Energy In (EPI)	1WH	Int32 (RO)	Secondary
302-303	Active Energy Out (EPE)	1WH	Int32 (RO)	Secondary
304-305	Reactive Energy In(EQL)	1WH	Int32 (RO)	Secondary
306-307	Reactive Energy Out (EQC)	1WH	Int32 (RO)	Secondary
1000	Temp1	0.1°C	Int16 (RO)	1st way temp
1001	Temp2	0.1°C	Int16 (RO)	2nd way temp
1002	Temp3	0.1°C	Int16 (RO)	3rd way temp
1003	Temp4	0.1°C	Int16 (RO)	4th way temp
1004	whd_temp	0.1°C	Int16 (RO)	Temperature and humidity sensor temperature
1005	whd_rh	0.1%	Int16 (RO)	Temperature and humidity sensor humidity
1006	Temperature and humidity sensor status		Int16 (RO)	Bit0: high temperature BIT1: low temperature BIT2: high humidity Bit3: Heating BIT4: blast bit7: Sensor status
1007-1021	Corresponding to the second and third module		Int16 (RO)	

Register	Description	Unit	Data Type	Parameters
1100-1101	Current, Phase A	0.001A	Int32 (RO)	Primary
1102-1103	Current, Phase B	0.001A	Int32 (RO)	Primary
1104-1105	Current, Phase C	0.001A	Int32 (RO)	Primary
1106-1107	Current, Neutral	0.001A	Int32 (RO)	Primary
1108-1109	Current, Average	0.001A	Int32 (RO)	Primary
1110	Current Unbalance, Phase A	0.1%	Int16 (RO)	Primary
1111	Current Unbalance, Phase B	0.1%	Int16 (RO)	Primary
1112	Current Unbalance, Phase C	0.1%	Int16 (RO)	Primary
1113	Current Unbalance, Max	0.1%	Int16 (RO)	Primary
1114	Current angle between IA and IB	0.1°	Int16 (RO)	
1115	Current angle between IB and IC	0.1°	Int16 (RO)	
1116	Current angle between IC and IA	0.1°	Int16 (RO)	
1120-1121	Voltage Phase A-N	0.1V	Int32 (RO)	Primary
1122-1123	Voltage Phase B-N	0.1V	Int32 (RO)	Primary
1124-1125	Voltage Phase C-N	0.1V	Int32 (RO)	Primary
1126-1127	Voltage Average L-N	0.1V	Int32 (RO)	Primary
1128-1129	Voltage Phase A-B	0.1V	Int32 (RO)	Primary
1130-1131	Voltage Phase B-C	0.1V	Int32 (RO)	Primary
1132-1133	Voltage Phase C-A	0.1V	Int32 (RO)	Primary
1134-1135	Voltage Average (L-L)	0.1V	Int32 (RO)	Primary
1136	Voltage Unbalance Phase A-N	0.1%	Int16 (RO)	Primary
1137	Voltage Unbalance Phase B-N	0.1%	Int16 (RO)	Primary
1138	Voltage Unbalance Phase C-N	0.1%	Int16 (RO)	Primary
1139	Voltage Unbalance, L-N	0.1%	Int16 (RO)	Primary
1140	Voltage Unbalance, Phase A-B	0.1%	Int16 (RO)	Primary
1141	Voltage Unbalance, Phase B-C	0.1%	Int16 (RO)	Primary
1142	Voltage Unbalance, Phase C-A	0.1%	Int16 (RO)	Primary
1143	Voltage Unbalance,L-L	0.1%	Int16 (RO)	Primary
1144	Voltage angle between UA and UB	0.1°	Int16 (RO)	

1145	Voltage angle between UB and UC	0.1°	Int16 (RO)	
1146	Voltage angle between UC and UA	0.1°	Int16 (RO)	
1150-1151	Active Power, Phase A	0.01W	Float (RO)	Primary
1152-1153	Active Power, Phase B	0.01W	Float (RO)	Primary
1154-1155	Active Power, Phase C	0.01W	Float (RO)	Primary
1156-1157	Active Power, Total	0.01W	Float (RO)	Primary
1158-1159	Reactive Power, Phase A	0.01Var	Float (RO)	Primary
1160-1161	Reactive Power, Phase B	0.01Var	Float (RO)	Primary
1162-1163	Reactive Power, Phase C	0.01Var	Float (RO)	Primary
1164-1165	Reactive Power, Total	0.01Var	Float (RO)	Primary
1166-1167	Real Power, Phase A	0.01VA	Float (RO)	Primary
1168-1169	Real Power, Phase B	0.01VA	Float (RO)	Primary
1170-1171	Real Power, Phase C	0.01VA	Float (RO)	Primary
1172-1173	Real Power, Total	0.01VA	Float (RO)	Primary
1174	Phase Angle between UA and IA	0.1°	Int16 (RO)	
1175	UB and IB phase Angle	0.1°	Int16 (RO)	
1176	Phase Angle between UC and IC	0.1°	Int16 (RO)	
1179	Nominal Frequency	0.01Hz	Int16 (RO)	Same as Address 252
1180	Active Power Factor, Phase A	0.001	Int16 (RO)	Same as Address 277
1181	Active Power Factor, Phase B	0.001	Int16 (RO)	Same as Address 278
1182	Active Power Factor, Phase C	0.001	Int16 (RO)	Same as Address 279
1183	Active Power Factor, Total	0.001	Int16 (RO)	Same as Address 280
1190	voltage crest factor,phase A	0.001	Int16 (RO)	
1191	voltage crest factor,phase B	0.001	Int16 (RO)	
1192	voltage crest factor,phase C	0.001	Int16 (RO)	
1193	Telephone waveform factor,phase A	0.01	Int16 (RO)	
1194	Telephone waveform factor,phase B	0.01	Int16 (RO)	
1195	Telephone waveform factor,phase C	0.01	Int16 (RO)	
1196	Phase A current K factor	0.01	Int16 (RO)	
1197	Phase B current K factor	0.01	Int16 (RO)	
1198	Phase C current K factor	0.01	Int16 (RO)	
1200-1201	Current Demand MAX, Phase A	0.001A	Int32 (RO)	Primary
1202-1203	Data and time the Current Demand MAX, Phase A		Int16 (RO)	BIT12~BIT15:Year BIT8~BIT12:Month BIT0~BIT7:Day
			Int16 (RO)	BIT8~BIT12:Hour BIT0~BIT7: Minute
1204-1207	Current Demand MAX, Phase B			Same phase A current
1208-1211	Current Demand MAX, Phase C			Same phase A current
1212-1213	Active Power Demand MAX, Total	0.01W	Float (RO)	Primary

1214-1215	Data and time the Active Power Demand MAX ,Total		Int16 (RO)	BIT12~BIT15:Year BIT8~BIT12:Month BIT0~BIT7:Day
			Int16 (RO)	BIT8~BIT12:Hour BIT0~BIT7: Minute
1216-1219	Reactive Power Demand MAX, Total	0.01Var	Float (RO)	Same phase A current
1220-1223	Real Power Demand MAX, Total	0.01VA	Float (RO)	Same phase A current
1250-1251	Current Demand MAX, Phase A	0.001A	Int32 (RO)	Primary
1252-1253	Current Demand MAX, Phase B	0.001A	Int32 (RO)	Primary
1254-1255	Current Demand MAX, Phase C	0.001A	Int32 (RO)	Primary
1260-1261	Active Power Demand , Total	0.01W	Float (RO)	Primary
1262-1263	Reactive Power Demand , Total	0.01Var	Float (RO)	Primary
1264-1265	Real Power Demand, Total	0.01VA	Float (RO)	Primary
1266-1267	A phase voltage positive sequence	0.1V	Int32 (RO)	Primary
1268-1269	Phase B voltage negative sequence	0.1V	Int32 (RO)	Primary
1270-1271	Phase C voltage zero sequence	0.1V	Int32 (RO)	Primary
1272-1273	A phase current positive sequence	0.001A	Int32 (RO)	Primary
1274-1275	B phase current negative sequence	0.001A	Int32 (RO)	Primary
1276-1277	C phase current zero sequence	0.001A	Int32 (RO)	Primary
1288	Current coefficient		Int16 (RW)	Used to set the alarm value and read the alarm record value. If the current coefficient is -3, the Phase A overcurrent alarm action value (register 1301) is set to 6000, then the actual alarm value is $6000 * 10^{(-3)} = 6.000A$
1289	Neutral current coefficient		Int16 (RW)	Refer to register 1288
1290	Voltage coefficient		Int16 (RW)	Refer to register 1288
1291	Power coefficient		Int16 (RW)	Refer to register 1288
1300	The first group of alarms: Phase A overcurrent alarm		Int16 (RW)	When Bit0 is 1, the alarm is enabled, when Bit0 is 0, the alarm is disabled; When Bit1 is 1, the zero-value alarm is disabled, when Bit1 is 0, the zero-value alarm is enabled.
1301	Alarm action value		Int16 (RW)	Primary. Range: 0 ~ 9999. If the current coefficient is -3, Phase A overcurrent alarm action value is set to 6000, then the actual

				alarm value is $6000 \times 10^{-3} = 6.000A$, other situation is similar..
1302	Alarm delay time	1s	Int16 (RW)	Range: 0 ~ 9999.
1303	Alarm recovery value		Int16 (RW)	Primary. Range: 0~9999
1304	Delay time of Recovery	1s	Int16 (RW)	Range: 0 ~ 9999.

Offset Address Table

Register	Description	unit	Data Type	Parameters
1117-1119	Current Offset	0.01%	Int16	(Actual value - nominal value)/nominal value
1270-1275	Voltage Offset	0.01%	Int16	(Actual value - nominal value)/nominal value
1276	Frequency Offse	0.01%	Int16	(Actual value - nominal value)/nominal value

The first group of other alarm settings: refer to Phase A overcurrent alarm

1305	Phase B overcurrent alarm	1310	Phase C overcurrent alarm	1315	Maximum overcurrent alarm
1320	Neutral overcurrent alarm	1325	Phase A undercurrent alarm	1330	Phase B undercurrent alarm
1335	Phase C undercurrent alarm	1340	Minimum undercurrent alarm	1345	Neutral undercurrent alarm
1350	Maximum current unbalance alarm	1355	Current loss alarm	1360	Phase A overvoltage alarm
1365	Phase B overvoltage alarm	1370	Phase C overvoltage alarm	1375	Maximum phase overvoltage alarm
1380	AB line overvoltage alarm	1385	BC line overvoltage alarm	1390	CA line overvoltage alarm
1395	Maximum line overvoltage alarm	1400	Phase A undervoltage alarm	1405	Phase B undervoltage alarm
1410	Phase C undervoltage alarm	1415	Minimum phase undervoltage alarm	1420	AB line undervoltage alarm
1425	BC line undervoltage alarm	1430	CA line undervoltage alarm	1435	Minimum line undervoltage alarm
1440	Maximum phase voltage unbalance alarm	1445	Maximum line voltage unbalance alarm	1450	Line voltage loss alarm
1455	Total active overpower alarm	1460	Total reactive overpower alarm	1465	Total apparent overpower alarm
1470	Total active underpower alarm	1475	Total reactive underpower alarm	1480	Total apparent underpower alarm
1485	Over power factor alarm	1490	Under power factor alarm	1495	Over frequency alarm
1500	Under frequency alarm	1505	Over total harmonic of Phase A current alarm	1510	Over total harmonic of Phase B current alarm
1515	Over total harmonic of Phase C current alarm	1520	Over total harmonic of Phase A voltage alarm	1525	Over total harmonic of Phase B voltage alarm
1530	Over total harmonic of Phase C voltage alarm	1535	Over total even harmonic of Phase A current alarm	1540	Over total even harmonic of Phase B current alarm
1545	Over total even harmonic of Phase C current alarm	1550	Over total even harmonic of Phase A voltage alarm	1555	Over total even harmonic of Phase B voltage alarm
1560	Over total even harmonic of Phase C voltage alarm	1565	Over total odd harmonic of Phase A current alarm	1570	Over total odd harmonic of Phase B current alarm
1575	Over total odd harmonic of Phase C current alarm	1580	Over total odd harmonic of Phase A voltage alarm	1585	Over total odd harmonic of Phase B voltage alarm
1590	Over total odd harmonic of Phase C voltage alarm	1595	Over total demand of active power alarm	1600	Under total demand of active power alarm
1605	Reverse phase sequence alarm	1610	DI1 digital input alarm	1615	DI2 digital input alarm

1620	DI3 digital input alarm	1625	DI4 digital input alarm	1630	1 st temp alarm
1635	2 nd temp alarm	1640	3 rd temp alarm	1645	4 th temp alarm

The second group of alarm settings: refer to Phase A overcurrent alarm

1750	Phase A overcurrent alarm	1755	Phase B overcurrent alarm	1760	Phase C overcurrent alarm
1765	Maximum overcurrent alarm	1770	Neutral overcurrent alarm	1775	Phase A undercurrent alarm
1780	Phase B undercurrent alarm	1785	Phase C undercurrent alarm	1790	Minimum undercurrent alarm
1795	Neutral undercurrent alarm	1800	Maximum current unbalance alarm	1805	Current loss alarm
1810	Phase A overvoltage alarm	1815	Phase B overvoltage alarm	1820	Phase C overvoltage alarm
1825	Maximum phase overvoltage alarm	1830	AB line overvoltage alarm	1835	BC line overvoltage alarm
1840	CA line overvoltage alarm	1845	Maximum line overvoltage alarm	1850	Phase A undervoltage alarm
1855	Phase B undervoltage alarm	1860	Phase C undervoltage alarm	1865	Minimum phase undervoltage alarm
1870	AB line undervoltage alarm	1875	BC line undervoltage alarm	1880	CA line undervoltage alarm
1885	Minimum line undervoltage alarm	1890	Maximum phase voltage unbalance alarm	1895	Maximum line voltage unbalance alarm
1900	Line voltage loss alarm	1905	Total active overpower alarm	1910	Total reactive overpower alarm
1915	Total apparent overpower alarm	1920	Total active underpower alarm	1925	Total reactive underpower alarm
1930	Total apparent underpower alarm	1935	Over power factor alarm	1940	Under power factor alarm
1945	Over frequency alarm	1950	Under frequency alarm	1955	Over total harmonic of Phase A current alarm
1960	Over total harmonic of Phase B current alarm	1965	Over total harmonic of Phase C current alarm	1970	Over total harmonic of Phase A voltage alarm
1975	Over total harmonic of Phase B voltage alarm	1980	Over total harmonic of Phase C voltage alarm	1985	Over total even harmonic of Phase A current alarm
1990	Over total even harmonic of Phase B current alarm	1995	Over total even harmonic of Phase C voltage alarm	2000	Over total even harmonic of Phase A voltage alarm
2005	Over total even harmonic of Phase B voltage alarm	2010	Over total even harmonic of Phase C voltage alarm	2015	Over total odd harmonic of Phase A current alarm
2020	Over total odd harmonic of Phase B current alarm	2025	Over total odd harmonic of Phase C current alarm	2030	Over total odd harmonic of Phase A voltage alarm
2035	Over total odd harmonic of Phase B voltage alarm	2040	Over total odd harmonic of Phase C voltage alarm	2045	Over total demand of active power alarm
2050	Under total demand of active power alarm	2055	Reverse phase sequence alarm	2060	DI1 digital input alarm
2065	DI2 digital input alarm	2070	DI3 digital input alarm	2075	DI4 digital input alarm
2080	1 st way temp alarm	2085	2 nd way temp alarm	2090	3 rd way temp alarm
2095	4 th way temp alarm				

Note: The action value of unbalance is the register value *0.1%, the action value of power factor is the register value *0.001, the action value of harmonic alarm is the register value *0.01%, and the action value of frequency alarm is the register value *0.01Hz.

Register (WORD)	Description	Unit	Data Type	Note
2200	Event record 1		UInt16 (RO)	When Bit15 is 1, it means DI. When it is 0, it

					means DO. When Bit14 is 1, it means ON. When it is 0, it means OFF. Low byte indicates DI/DO number.
2201		Year、 Month		UInt16 (RO)	High byte:Year; Low byte: Month
2202		Day、 Hour		UInt16 (RO)	High byte: Day ; Low byte: Hour
2203		Minute、 second		UInt16 (RO)	High byte:Year; Low byte: Month

Other event records: Refer to event record 1

2204	Event record 2	2208	Event record 3	2212	Event record 4	2216	Event record 5	2220	Event record 6
2224	Event record 7	2228	Event record 8	2232	Event record 9	2236	Event record 10	2240	Event record 11
2244	Event record 12	2248	Event record 13	2252	Event record 14	2256	Event record 15	2260	Event record 16

Note: To read the most recent 128 event records, you can read the register 20000-20513, refer to the format of register 2200-2203.

Register (WORD)	Name	Resolution	Data(Read and write attribute)	Remarks
2280	1ST group alarm state		UInt16 (RO)	Bit0-bit15 (the lowest digit is Bit0) corresponds to alarm number 0-15.For example: BIT0 corresponds to A phase overcurrent alarm, and so on
2281			UInt16 (RO)	Corresponding alarm number 16-31
2282			UInt16 (RO)	Corresponding alarm number 32-47
2283			UInt16 (RO)	Corresponding alarm number48-63
2284			UInt16 (RO)	Corresponding alarm number64-79
2285			UInt16 (RO)	Corresponding alarm number80-95
2286-2291	2nd group alarm state			Same with 1ST group alarm state

Register (WORD)	Description	Unit	Data Type	Note
2300	Recent alarm record 1	Alarm type	UInt16 (RO)	High byte: Alarm group; Low byte: Alarm type (refer to 7.4 to view alarms - Communication number of alarm classification description)
2301		Year、 Month	UInt16 (RO)	High byte: Year; Low byte: Month
2302		Day、 Hour	UInt16 (RO)	High byte: Day ; Low byte: Hour
2303		Minute、 second	UInt16 (RO)	High byte:Year; Low byte: Month
2304		Alarm value	UInt16 (RO)	Primary
2305		Alarm status	UInt16 (RO)	1: Alarm acts 0: Alarm released

Other recent alarm records: Refer to recent alarm record 1

2306	Alarm record 2	2312	Alarm record 3	2318	Alarm record 4	2324	Alarm record 5	2330	Alarm record 6
2336	Alarm record 7	2342	Alarm record 8	2348	Alarm record 9	2354	Alarm record 10	2360	Alarm record 11
2366	Alarm record 12	2372	Alarm record 13	2378	Alarm record 14	2384	Alarm record 15	2390	Alarm record 16

Classification of alarm records (16 for each type of alarm, polling display, latest record covers the earliest record automatically): Refer to recent alarm record 1 for data format.

10000	Phase A overcurrent alarm (16 in	10096	Phase B overcurrent alarm	10192	Phase C overcurrent alarm
-------	----------------------------------	-------	---------------------------	-------	---------------------------

	total, the same below)				
10288	Maximum overcurrent alarm	10384	Neutral overcurrent alarm	10480	Phase A undercurrent alarm
10576	Phase B undercurrent alarm	10672	Phase C undercurrent alarm	10768	Minimum undercurrent alarm
10864	Neutral undercurrent alarm	10960	Maximum current unbalance alarm	11056	Current loss alarm
11152	Phase A overvoltage alarm	11248	Phase B overvoltage alarm	11344	Phase C overvoltage alarm
11440	Maximum phase overvoltage alarm	11536	AB line overvoltage alarm	11632	BC line overvoltage alarm
11728	CA line overvoltage alarm	11824	Maximum line overvoltage alarm	11920	Phase A undervoltage alarm
12016	Phase B undervoltage alarm	12112	Phase C undervoltage alarm	12208	Minimum phase undervoltage alarm
12304	AB line undervoltage alarm	12400	BC line undervoltage alarm	12496	CA line undervoltage alarm
12592	Minimum line undervoltage alarm	12688	Maximum phase voltage unbalance alarm	12784	Maximum line voltage unbalance alarm
12880	Line voltage loss alarm	12976	Total active overpower alarm	13072	Total reactive overpower alarm
13168	Total apparent overpower alarm	13264	Total active underpower alarm	13360	Total reactive underpower alarm
13456	Total apparent underpower alarm	13552	Over power factor alarm	13648	Under power factor alarm
13744	Over frequency alarm	13840	Under frequency alarm	13936	Over total harmonic of Phase A current alarm
14032	Over total harmonic of Phase B current alarm	14128	Over total harmonic of Phase C current alarm	14224	Over total harmonic of Phase A voltage alarm
14320	Over total harmonic of Phase B voltage alarm	14416	Over total harmonic of Phase C voltage alarm	14512	Over total even harmonic of Phase A current alarm
14608	Over total even harmonic of Phase B current alarm	14704	Over total even harmonic of Phase C current alarm	14800	Over total even harmonic of Phase A voltage alarm
14896	Over total even harmonic of Phase B voltage alarm	14992	Over total even harmonic of Phase C voltage alarm	15088	Over total odd harmonic of Phase A current alarm
15184	Over total odd harmonic of Phase B current alarm	15280	Over total odd harmonic of Phase C current alarm	15376	Over total odd harmonic of Phase A voltage alarm
15472	Over total odd harmonic of Phase B voltage alarm	15568	Over total odd harmonic of Phase C voltage alarm	15664	Over total demand of active power alarm
15760	Under total demand of active power alarm	15856	Reverse phase sequence alarm	15952	DI1 digital input alarm
16048	DI2 digital input alarm	16144	DI3 digital input alarm	16240	DI4 digital input alarm
16336	1 st way temp alarm	16432	2 nd way temp alarm	16528	3 rd way temp alarm
16624	4 th way temp alarm				

Register (WORD)	Description	Unit	Data Type	Note
2500	Function selection of relay 1		UInt16 (RW)	0: Remote control; 1: First group alarm; 2: Second group alarm
2501-2531	Function selection of relay 2-32			Same as function selection of relay 1
2532	Output pulse width of relay 1 (effective by remote control)	1s	Int16 (RW)	When the delay time 0, it is a level trigger mode; when it is greater than 0, it is a pulse trigger mode.
2533-2563	Output pulse width of relay 2-32 (effective by remote control)			Same as output pulse width of relay 1

2564-2569	Reserve			
2570-2571	Initial state of switch input		Int32 (RW)	Bits0:DI1, and so on, Bits31:DI32; 1: Initial state is ON; 0: Initial state is OFF
2572-2573	Initial state of switch output		Int32 (RW)	Bits0:DO1, and so on, Bits31:DO32; 1: Initial state is ON; 0: Initial state is OFF
2574-2579	Reserve			
2580-2581	Current status of switch input		Int32 (RO)	Bits0:DI1, and so on, Bits31:DI32; 1: Initial state is ON; 0: Initial state is OFF
2582-2583	Current status of switch output		Int32 (RW)	Bits0:DO1, and so on, Bits31:DO32; 1: Initial state is ON; 0: Initial state is OFF
2584-2589	Reserve			
2590-2601	Associated alarm configuration of relay 1		Int32(RW)*6	See 2.9 DO settings in the instructions

Associated alarm configuration of other relays: Refer to associated alarm configuration of relay 1.

2602	Associated alarm configuration of relay 2	2614	Associated alarm configuration of relay 3	2626	Associated alarm configuration of relay 4
2638	Associated alarm configuration of relay 5	2650	Associated alarm configuration of relay 6	2662	Associated alarm configuration of relay 7
2674	Associated alarm configuration of relay 8	2686	Associated alarm configuration of relay 9	2698	Associated alarm configuration of relay 10
2710	Associated alarm configuration of relay 11	2722	Associated alarm configuration of relay 12	2734	Associated alarm configuration of relay 13
2746	Associated alarm configuration of relay 14	2758	Associated alarm configuration of relay 15	2770	Associated alarm configuration of relay 16
2782	Associated alarm configuration of relay 17	2794	Associated alarm configuration of relay 18	2806	Associated alarm configuration of relay 19
2818	Associated alarm configuration of relay 20	2830	Associated alarm configuration of relay 21	2842	Associated alarm configuration of relay 22
2854	Associated alarm configuration of relay 23	2866	Associated alarm configuration of relay 24	2878	Associated alarm configuration of relay 25
2890	Associated alarm configuration of relay 26	2902	Associated alarm configuration of relay 27	2914	Associated alarm configuration of relay 28
2926	Associated alarm configuration of relay 29	2938	Associated alarm configuration of relay 30	2950	Associated alarm configuration of relay 31
2962	Associated alarm configuration of relay 32				

Register (WORD)	Description	Unit	Data Type	Note	
3000-3001	Positive active energy(IMP)	1Wh	Float (RO)	Primary energy	
3002-3003	Reverse active energy (EXP)	1Wh	Float (RO)	Primary energy	
3004-3005	Inductive reactive energy (EQL)	1varh	Float (RO)	Primary energy	
3006-3007	Capacitive reactive energy (EQC)	1varh	Float (RO)	Primary energy	
3500-3501	Maximum of	Maximum	0.001A	Int32 (RO)	Primary
3502	Phase A current in	Year and month of occurrence		Int16 (RO)	High byte: Year; Low byte: Month

3503	this month	Day and hour of occurrence		Int16 (RO)	High byte: Day; Low byte: Hour
3504		Minute and second of occurrence		Int16 (RO)	High byte: Minute; Low byte: Second
3505-3509	Maximum of Phase B current in this month				Same as maximum of Phase A current in this month
3510-3514	Maximum of Phase C current in this month				Same as maximum of Phase A current in this month
3515-3519	Maximum of neutral current in this month				Same as maximum of Phase A current in this month
3520-3524	Maximum of average current in this month				Same as maximum of Phase A current in this month
3525-3526	Maximum of Phase A voltage in this month	Maximum	0.1V	Int32 (RO)	Primary
3527		Year and month of occurrence		Int16 (RO)	High byte: Year; Low byte: Month
3528		Day and hour of occurrence		Int16 (RO)	High byte: Day; Low byte: Hour
3529		Minute and second of occurrence		Int16 (RO)	High byte: Minute; Low byte: Second
3530-3534	Maximum of Phase B voltage in this month				Same as maximum of Phase A current in this month
3535-3539	Maximum of Phase C voltage in this month				Same as maximum of Phase A current in this month
3540-3544	Maximum of average phase voltage in this month				Same as maximum of Phase A current in this month
3545-3549	Maximum of AB line voltage in this month				Same as maximum of Phase A current in this month
3550-3554	Maximum of BC line voltage in this month				Same as maximum of Phase A current in this month
3555-3559	Maximum of CA line voltage in this month				Same as maximum of Phase A current in this month
3560-3564	Maximum of average line voltage in this month				Same as maximum of Phase A current in this month
3565-3566	Maximum of Phase A active power in this month	Maximum	0.01W	Float (RO)	Primary
3567		Year and month of occurrence		Int16 (RO)	High byte: Year; Low byte: Month
3568		Day and hour of occurrence		Int16 (RO)	High byte: Day; Low byte: Hour
3569		Minute and second of occurrence		Int16 (RO)	High byte: Minute; Low byte: Second
3570-3574	Maximum of Phase B active power in this month				Same as maximum of Phase A active power in this month
3575-3579	Maximum of Phase C active				Same as maximum of Phase A active power in

	power in this month				this month
3580-3584	Maximum of total phase active power in this month				Same as maximum of Phase A active power in this month
3585-3586	Maximum of Phase A reactive power in this month	Maximum	0.01Var	Float (RO)	Primary
3587		Year and month of occurrence		Int16 (RO)	High byte: Year; Low byte: Month
3588		Day and hour of occurrence		Int16 (RO)	High byte: Day; Low byte: Hour
3589		Minute and second of occurrence		Int16 (RO)	High byte: Minute; Low byte: Second
3590-3594	Maximum of Phase B reactive power in this month				Same as maximum of Phase A reactive power in this month
3595-3599	Maximum of Phase C reactive power in this month				Same as maximum of Phase A reactive power in this month
3600-3604	Maximum of total reactive power in this month				Same as maximum of Phase A reactive power in this month
3605-3606	Maximum of Phase A apparent power in this month	Maximum	0.01VA	Float (RO)	Primary
3607		Year and month of occurrence		Int16 (RO)	High byte: Year; Low byte: Month
3608		Day and hour of occurrence		Int16 (RO)	High byte: Day; Low byte: Hour
3609		Minute and second of occurrence		Int16 (RO)	High byte: Minute; Low byte: Second
3610-3614	Maximum of Phase B apparent power in this month				Same as maximum of Phase A apparent power in this month
3615-3619	Maximum of Phase C apparent power in this month				Same as maximum of Phase A apparent power in this month
3620-3624	Maximum of total apparent power in this month				Same as maximum of Phase A apparent power in this month
3625-3626	Phase A power factor in this month	Maximum	0.001	Int32 (RO)	Primary
3627		Year and month of occurrence		Int16 (RO)	High byte: Year; Low byte: Month
3628		Day and hour of occurrence		Int16 (RO)	High byte: Day; Low byte: Hour
3629		Minute and second of occurrence		Int16 (RO)	High byte: Minute; Low byte: Second
3630-3634	Phase B power factor in this month				Same with Phase A power factor in this month
3635-3639	Phase C power factor in this month				Same with Phase A power factor in this month
3640-3644	Total power factor in this month				Same with Phase A power factor in this month
3645-3646	Frequency in this month	Maximum	0.01	Int32 (RO)	Primary
3647		Year and month of occurrence		Int16 (RO)	High byte: Year; Low byte: Month

3648		Day and hour of occurrence		Int16 (RO)	High byte: Day; Low byte: Hour
3649		Minute and second of occurrence		Int16 (RO)	High byte: Minute; Low byte: Second
3650-3651		Maximum	0.01%	Int32 (RO)	
3652	THD of Phase A current in this month	Year and month of occurrence		Int16 (RO)	High byte: Year; Low byte: Month
3653		Day and hour of occurrence		Int16 (RO)	High byte: Day; Low byte: Hour
3654		Minute and second of occurrence		Int16 (RO)	High byte: Minute; Low byte: Second
3655-3659	Maximum THD of Phase B current in this month				Same as THD of Phase A current in this month
3660-3664	Maximum THD of Phase C current in this month				Same as THD of Phase A current in this month
3665-3669	Maximum THD of Phase A voltage in this month				Same as THD of Phase A current in this month
3670-3674	Maximum THD of Phase B voltage in this month				Same as THD of Phase A current in this month
3675-3679	Maximum THD of Phase C voltage in this month				Same as THD of Phase A current in this month

Minimum in this month, maximum in previous month, minimum in last month: Refer to maximum in this month.

3680	Minimum of Phase A current in this month	3685	Minimum of Phase B current in this month	3690	Minimum of Phase C current in this month
3695	Minimum of neutral current in this month	3700	Minimum of average current in this month	3705	Minimum of Phase A voltage in this month
3710	Minimum of Phase B voltage in this month	3715	Minimum of Phase C voltage in this month	3720	Minimum of average voltage in this month
3725	Minimum of AB line voltage in this month	3730	Minimum of BC line voltage in this month	3735	Minimum of CA line voltage in this month
3740	Minimum of average line voltage in this month	3745	Minimum of Phase A active power in this month	3750	Minimum of Phase B active power in this month
3755	Minimum of Phase C active power in this month	3760	Minimum of total active power in this month	3765	Minimum of Phase A reactive power in this month
3770	Minimum of Phase B reactive power in this month	3775	Minimum of Phase C reactive power in this month	3780	Minimum of total reactive power in this month
3785	Minimum of Phase A apparent power in this month	3790	Minimum of Phase B apparent power in this month	3795	Minimum of Phase C apparent power in this month
3800	Minimum of total apparent power in this month	3805	Minimum of Phase A power factor in this month	3810	Minimum of Phase B power factor in this month
3815	Minimum of Phase C power factor in this month	3820	Minimum of total power factor in this month	3825	Minimum of frequency in this month
3830	Minimum THD of Phase A current in this month	3835	Minimum THD of Phase B current in this month	3840	Minimum THD of phase current in this month

3845	Minimum THD of Phase A voltage in this month	3850	Minimum THD of Phase B voltage in this month	3855	Minimum THD of Phase C voltage in this month
3860	Maximum of Phase A current in last month	3865	Maximum of phase current in last month	3870	Maximum of Phase C current in last month
3875	Maximum of neutral current in last month	3880	Maximum of avreage current in last month	3885	Maximum of Phase A voltage in last month
3890	Maximum of Phase B voltage in last month	3895	Maximum of Phase C voltage in last month	3900	Maximum of average voltage in last month
3905	Maximum of AB line voltage in last month	3910	Maximum of BC line voltage in last month	3915	Maximum of CA line voltage in last month
3920	Maximum of average line voltage in last month	3925	Maximum of Phase A active power in last month	3930	Maximum of Phase B active power in last month
3935	Maximum of Phase C active power in last month	3940	Maximum of total active power in last month	3945	Maximum of Phase A reactive power in last month
3950	Maximum of Phase B reactive power in last month	3955	Maximum of Phase C reactive power in last month	3960	Maximum of total reactive power in last month
3965	Maximum of Phase A apparent power in last month	3970	Maximum of Phase B apparent power in last month	3975	Maximum of Phase C apparent power in last month
3980	Maximum of total apparent power in last month	3985	Maximum of Phase A power factor in last month	3990	Maximum of Phase B power factor in last month
3995	Maximum of Phase C power factor in last month	4000	Maximum of total power factor in last month	4005	Maximum of frequency in last month
4010	Maximum THD of Phase A current in last month	4015	Maximum THD of Phase B current in last month	4020	Maximum THD of Phase C current in last month
4025	Maximum THD of Phase A voltage in last month	4030	Maximum THD of Phase B voltage in last month	4035	Maximum THD of Phase C voltage in last month
4040	Minimum of Phase A current in last month	4045	Minimum of Phase B current in last month	4050	Minimum of Phase C current in last month
4055	Minimum of neutral current in last month	4060	Minimum of average current in last month	4065	Minimum of Phase A voltage in last month
4070	Minimum of Phase B voltage in last month	4075	Minimum of Phase C voltage in last month	4080	Minimum of average voltage in last month
4085	Minimum of AB line voltage in last month	4090	Minimum of BC line voltage in last month	4095	Minimum of CA line voltage in last month
4100	Minimum of average line voltage in last month	4105	Minimum of Phase A active power in last month	4110	Minimum of Phase B active power in last month
4115	Minimum of Phase C active power in last month	4120	Minimum of total active power in last month	4125	Minimum of Phase A reactive power in last month
4130	Minimum of Phase B reactive power in last month	4135	Minimum of Phase C reactive power in last month	4140	Minimum of total reactive power in last month
4145	Minimum of Phase A apparent power in last month	4150	Minimum of Phase B apparent power in last month	4155	Minimum of Phase C apparent power in last month
4160	Minimum of total apparent power in last month	4165	Minimum of Phase A power factor in last month	4170	Minimum of Phase B power factor in last month
4175	Minimum of Phase C power factor in last month	4180	Minimum of total power factor in last month	4185	Minimum of frequency in last month
4190	Minimum THD of Phase A	4195	Minimum THD of Phase B current	4200	Minimum THD of Phase C

	current in last month		in last month		current in last month
4205	Minimum THD of Phase A voltage in last month	4210	Minimum THD of Phase B voltage in last month	4215	Minimum THD of Phase C voltage in last month

Register (WORD)	Description	Unit	Data Type	Note
4500-4561	2nd-63rd harmonic of Phase A current	0.01%	Int16 (RO)	
4562-4623	2nd-63rd harmonic of Phase B current	0.01%	Int16 (RO)	
4624-4685	2nd-63rd harmonic of Phase C current	0.01%	Int16 (RO)	
4686-4747	2nd-63rd harmonic of Phase A voltage	0.01%	Int16 (RO)	
4748-4809	2nd-63rd harmonic of Phase B voltage	0.01%	Int16 (RO)	
4810-4871	2nd-63rd harmonic of Phase C voltage	0.01%	Int16 (RO)	
4872	THD of Phase A current	0.01%	Int16 (RO)	
4873	THD of Phase B current	0.01%	Int16 (RO)	
4874	THD of Phase B current	0.01%	Int16 (RO)	
4875	THD of Phase A voltage	0.01%	Int16 (RO)	
4876	THD of Phase B voltage	0.01%	Int16 (RO)	
4877	THD of Phase C voltage	0.01%	Int16 (RO)	
4878	Total odd harmonic distortion (TOHD) of Phase A current	0.01%	Int16 (RO)	
4879	TOHD of Phase B current	0.01%	Int16 (RO)	
4880	TOHD of Phase C current	0.01%	Int16 (RO)	
4881	TOHD of Phase A voltage	0.01%	Int16 (RO)	
4882	TOHD of Phase B voltage	0.01%	Int16 (RO)	
4883	TOHD of Phase C voltage	0.01%	Int16 (RO)	
4884	Total even harmonic distortion (TEHD) of Phase A current	0.01%	Int16 (RO)	
4885	TEHD of Phase B current	0.01%	Int16 (RO)	
4886	TEHD of Phase C current	0.01%	Int16 (RO)	
4887	TEHD of Phase A voltage	0.01%	Int16 (RO)	
4888	TEHD of Phase B voltage	0.01%	Int16 (RO)	
4889	TEHD of Phase C voltage	0.01%	Int16 (RO)	
4890-4891	Total RMS value of phase A fundamental current	0.001A	Int32 (RO)	Primary
4892-4893	Total RMS value of phase B fundamental current	0.001A	Int32 (RO)	Primary
4894-4895	Total RMS value of phase C fundamental current	0.001A	Int32 (RO)	Primary
4896-4897	Total RMS value of phase A fundamental voltage	0.1V	Int32 (RO)	Primary

4898-4899	Total RMS value of phase B fundamental voltage	0.1V	Int32 (RO)	Primary	
4900-4901	Total RMS value of phase C fundamental voltage	0.1V	Int32 (RO)	Primary	
4902-4903	Total RMS value of Phase A harmonic current	0.001A	Int32 (RO)	Primary	
4904-4905	Total RMS value of Phase B harmonic current	0.001A	Int32 (RO)	Primary	
4906-4907	Total RMS value of Phase C harmonic current	0.001A	Int32 (RO)	Primary	
4908-4909	Total RMS value of Phase A harmonic voltage	0.1V	Int32 (RO)	Primary	
4910-4911	Total RMS value of Phase B harmonic voltage	0.1V	Int32 (RO)	Primary	
4912-4913	Total RMS value of Phase C harmonic voltage	0.1V	Int32 (RO)	Primary	
4914-5399	Reserve				
5400	Setting of the 1st transmission output	Transmission type and signal selection	Int16 (RW)	High byte: Transmission type (1:4-20mA, 2:0-20mA, 3:1-5V, 4:0-5V) Low Byte: Signal Selection (Refer to Table 3 in 7.5 System Setup - Analog Output Settings)	For example: 4-20mA is selected for the transmission type, and phase A current is selected for the signal. The corresponding value of the high point is 5000, and the corresponding value of the low point is 0, and the actual decimal point of the current display is 3 bits. When the actual current value of phase A is 5.000A, the transmission output is 20mA. When the actual current value of phase A current is 0, the output is 4 mA. When the actual current value of phase A is 2.500 A, the transmission output is 12 mA.
5401		Corresponding value of the high point	Int16 (RW)	Primary	
5402		Corresponding value of the low point	Int16 (RW)	Primary	

Other settings of transmission output: refer to setting of the 1st transmission output

5403	Setting of the 2nd transmission output	5406	Setting of the 3rd transmission output	5409	Setting of the 4th transmission output
5412	Setting of the 5th transmission output	5415	Setting of the 6th transmission output	5418	Setting of the 7th transmission output
5421	Setting of the 8th transmission output	5424	Setting of the 9th transmission output	5427	Setting of the 10th transmission output

5430	Setting of the 11th transmission output	5433	Setting of the 12th transmission output	5436	Setting of the 13th transmission output
5439	Setting of the 14th transmission output	5442	Setting of the 15th transmission output	5445	Setting of the 16th transmission output
5448	Setting of the 17th transmission output	5451	Setting of the 18th transmission output	5454	Setting of the 19th transmission output
5457	Setting of the 20th transmission output	5460	Setting of the 21st transmission output	5463	Setting of the 22nd transmission output
5466	Setting of the 23rd transmission output	5469	Setting of the 24th transmission output	5472	Setting of the 25th transmission output
5475	Setting of the 26th transmission output	5478	Setting of the 27th transmission output	5481	Setting of the 28th transmission output
5484	Setting of the 29th transmission output	5487	Setting of the 30th transmission output	5490	Setting of the 31st transmission output
5493	Setting of the 32nd transmission output	5496		5499	

Register (WORD)	Description		Unit	Data Type	Note	
5600	Setting of the 1st analog input	Input type and decimal point of display		Int16 (RW)	High byte: Input type (1:4-20mA, 2:0-20mA, 3:1-5V, 4:0-5V) Low Byte: Decimal point of display (0-3)	For example: 4-20mA is selected for the input type, and decimal point is 3 digits. The display value of input high point is set to 5000, and the display value of input low point is 0. When the analog input is 20mA, the display value is 5.000, when the analog input is 4mA, the display value is 0.000, and when the analog input is 12mA, the display value is 2.500.
5601		Display value of input high point		Int16 (RW)	The display value of input high point (0-9999)	
5602		Display value of input low point		Int16 (RW)	The display value of input low point (0-9999)	

Other settings of analog input: Refer to the 1st analog input settings

5603	Setting of the 2nd analog input	5606	Setting of the 3rd analog input	5609	Setting of the 4th analog input
5612	Setting of the 5th analog input	5615	Setting of the 6th analog input	5618	Setting of the 7th analog input
5621	Setting of the 8th analog input	5624	Setting of the 9th analog input	5627	Setting of the 10th analog input
5630	Setting of the 11th analog input	5633	Setting of the 12th analog input	5636	Setting of the 13th analog input
5639	Setting of the 14th analog input	5642	Setting of the 15th analog input	5645	Setting of the 16th analog input
5648	Setting of the 17th analog input	5651	Setting of the 18th analog input	5654	Setting of the 19th analog input
5657	Setting of the 20th analog input	5660	Setting of the 21st analog input	5663	Setting of the 22nd analog input
5666	Setting of the 23rd analog input	5669	Setting of the 24th analog input	5672	Setting of the 25th analog input
5675	Setting of the 26th analog input	5678	Setting of the 27th analog input	5681	Setting of the 28th analog input
5684	Setting of the 29th analog input	5687	Setting of the 30th analog input	5690	Setting of the 31st analog input
5693	Setting of the 32nd analog input				

Register (WORD)	Description	Unit	Data Type	Note
5696-5727	Inverse value of No.1-32 analog Input		Int16 (RO)	Inverse value of No.1-32 analog Input
5728-5759	The actual value of No.1-32 analog Input	0.001	Int16 (RO)	The unit is mA when the input selection is 4-20mA or 0-20mA, and the unit is V when 1-5V or 0-5V is selected.

Note: 1. Read-write property: "RO" is read-only, parameter is read with 0X03H command; "R/W" is readable and writable, and system parameter is written with 0X10H command. Do not write data to unlisted or unwritable Address.

2、 For Int32 type data, the high bits are in the front and the low bits are in the back

8.3 Correspondence between communication value and actual value

It is agreed that Val_t is the communication readout value and Val_s is the actual value.

8.3.1 Voltage, Current, Power Factor, Frequency, Unbalance (Secondary)

The series of measured values are read with 03 command of the Modbus-RTU communication protocol. Each item occupies 1 word. The correspondence between the communication value and the actual secondary measurement value is shown in the following table:

Applicable parameters	Resolution	Correspondence	Unit
Voltage ,Uan、 Ubn、 Ucn、 Uab、 Ubc、 Uca	0.1V	Val_s=Val_t*0.1	V
Current ,I _A 、 I _B 、 I _C	0.001A	Val_s=Val_t*0.001	A
Power factor, PF _A 、 PF _B 、 PF _C 、 PF _Σ	0.001	Val_s=Val_t*0.001	No unit
Frequency, F	0.01Hz	Val_s=Val_t*0.01	Hz
Unbalance ,I(ubl), ULL(ubl),ULN(ubl)	0.1	Val_s=Val_t*0.1	%

For example: To read phase A voltage Uan, the data can be read at address 243 in Int16eger reading mode by MODSCAN, the communication read-out value Val_t is 2200,then Val_s = 2200*0.1=220V.

8.3.2 Voltage, Current, Power Factor, Frequency, Unbalance (Primary)

The series of measured values are read with 03 command of the Modbus-RTU communication protocol. The voltage and current occupy 2 words, and the power factor, frequency, and unbalance occupy 1 byte. The correspondence between the communication value and the actual secondary measurement value is shown in the following table:

Applicable parameters	Resolution	Correspondence	Unit
Voltage,Uan、 Ubn、 Ucn、 Uab、 Ubc、 Uca	0.1V	Val_s=Val_t*0.1	V
Current ,I _A 、 I _B 、 I _C	0.001A	Val_s=Val_t*0.001	A
Power factor, PF _A 、 PF _B 、 PF _C 、 PF _{Total}	0.001	Val_s=Val_t*0.001	No unit
Frequency, F	0.01Hz	Val_s=Val_t*0.01	Hz
Unbalance ,I(ubl), ULL(ubl),ULN(ubl)	0.1	Val_s=Val_t*0.1	%

For example: To read phase A voltage Uan, the data can be read at address 1120-1121 in Int16eger reading mode by MODSCAN,the communication read-out value is 9 at address 1120, communication read-out value is 10176 at address 1121,that is, communication read-out value Val_t is 9*65536+10176 = 600000, then Val_s = Val_t*0.1=600000*0.1=60kV.

8.3.3 Active power, reactive power, apparent power and energy (Secondary side; W/Var/VA/kWh)

The series of measured values are read with 03 command of the Modbus-RTU communication protocol. Each item occupies 1 word. The power resolution 0.01, the correspondence between the communication value and the actual value is as follows: Val_s=Val_t*0.01; The energy resolution is 1, and the correspondence between the communication value and the actual value is as follows: Val_s=Val_t*1; where Val_t=first word*65536+second word.

For example: To read phase A active power Pa, the data can be read at address 253-254 in Int16eger reading mode by MODSCAN ,the communication read-out value is 1 at address 253 and 26000 at address 254, that is ,Val_t=1*65536+26000=91536, then Val_s = Val_t*0.01 = 915.36W.

For example: To read positive active energy IMP, the data can be read at address 300-301 MODSCAN in Int16eger reading mode by MODSCAN , the communication read-out

value is 0 at address 300 and 19000 at address 301, that is, $Val_t=0x65536+19000=19000$, then $Val_s=Val_t*1=19000Wh=19kWh$.

8.3.4 Active power, reactive power, apparent power and energy (primary side; W/Var/VA/kWh)

The series of measured values are read with 03 command of the Modbus-RTU communication protocol. Each item occupies a float (two words). The power resolution is 0.01, and the correspondence between the communication value and the actual value is as follows: $Val_s=Val_t*0.01$; the energy resolution is 1, and the correspondence between the communication value and the actual value is as follows: $Val_s=Val_t*1$; Val_t is calculated as follows:

For example: To read phase A active power PA, the data can be read at address 1150-1151 in Floating Pt reading mode by MODSCAN,the read-out value $Val_t=110000$, then $Val_s=Val_t*0.01=1100W$.

For example: To read phase positive active energy IMP, the data can be read at address 3050-3051 in Floating Pt reading mode by MODSCAN,the read-out value $Val_t=589000$, then $Val_s =Val_t*1=589000Wh=589kWh$.

8.3.5 Harmonic data of voltage and current

The series of measured values are read with 03 command of the Modbus-RTU communication protocol. Each item occupies 1 word. The resolution is 0.01, and the correspondence between the communication value and the actual value is as follows: $Val_s=(Val_t*0.01)$.

For example: To read current 3rd harmonic content, the data can be read at address 4501 in Integer reading mode by MODSCAN, the communication readout Val_t is 157, then $Val_s = (Val_t*0.01)\%=1.57\%$.

8.3.6 Demand

Demand includes three phase currents and active power, reactive power, and the maximum demand of apparent power and time of occurrence. The demand data format is as follows:

Address	Address 1	Address 2	Address 3				Address 4	
Content	H16	L16	H8			L8	H8	L8
	INT32		H4		L4			
	Demand value		Year (Only a bit is reserved, ten bit needs to be filled in according to the current time)			Month	Day	Hour

Note: H8 indicates eight high bits, L8 indicates eight low bits,and others are similar.

Take reading the maximum demand of phase A current (1200~1203) as an example, the read-out value is 0x0000 0x157C 0x7512 0x0E16

Address	1200	1201	1202				1203		
Content	H16	L16	H8			L8	H8	L8	
			H4		L4				
	Demand value		Year			Month	Day	Hour	Minute
Analysis	0*65536+0x157C=5500		17 (ten bit needs to be filled in according to the current time)			5	18	14	22

The maximum demand for Phase A current is: At 14:22 on May 18, 2017, the demand value is 5.500A.

8.3.7 Event Record

Event record 1 - event record 16, recorded in order of time, that is, event record 1 records the data of the most recent event, and event record 16 records the data of the earliest event, the data format of each event record is as follows:

Address	Address 1								Address 2		Address 3		Address 4		
内容 Content	H8								L8	H8	L8	H8	L8	H8	L8
	B7	B6	B5	B4	B3	B2	B1	B0							
	0: DO	0:Open							Switch number	Year	Month	Day	Hour	Minute	Second

	1: DI	1:Closed												
--	-------	----------	--	--	--	--	--	--	--	--	--	--	--	--

Take reading the event record 1 (2200~2203) as an example, the read-out value is **0x4000 0x1101 0x160D 0x3820**.

Address	2200								2201		2202		2203		
Content	H8								L8		H8	L8	H8	L8	
	B7	B6	B5	B4	B3	B2	B1	B0							
	0	1	0	0	0	0	0	0	0	0x11	0x01	0x16	0x0D	0x38	0x20
	0: DO 1: DI	0:Open 1:Closed							Switch number	年 Year	Month	Day	Hour	Minute	Second
Analysis	DO	Closed							DO1	17	1	22	14	56	32

DO1 changed from open to closed at 14:56:32 on January 22,2017.

8.3.8 Alarm Record

The data format of the alarm record is as follows:

Address	Address 1				Address 2		Address 3		Address 4		Address 5	Address 6
Content	H8		L8		H8	L8	H8	L8	H8	L8		
	Alarm group 0: The alarms of the first group 1: The alarms of the second group		Alarm type (Refer to 7.4 Alarms viewing - entry number for alarm classification description)		Year	Month	Day	Hour	Minute	Second	Alarm value	Alarm status

Take reading the latest alarm record (2300-2305) as an example, the read-out value is **0x000C 0x1101 0x160E 0x3820 0x0960 0x0001**.

Address	2300		2301		2302		2303		2304	2305
Content	H8		L8		H8	L8	H8	L8		
	0x00		0x0C		0x11	0x01	0x16	0x0E	0x38	0x20
	Alarm group		Alarm type		Year	Month	Day	Hour	Minute	Second
Analysis	The alarms of the first group		Phase A overvoltage alarm		17	1	22	14	56	32
									2400	Act

Phase A overvoltage alarm (the first group of alarms) occurs at 14:56:32, January 22, 2017, the alarm value is 240.0V.

8.3.9 DO Settings

Associated alarm configuration format of do settings is as follows:

Address	Address 1				Address 2			
Content	H16				L16			
	INT32							
	B31		B30	B29	...	B2	B1	B0
	Associated with the alarm number 31 of the first group (Alarm of over active power)				...and so on			Associated with the alarm number 0 of the first group (phase A

									overcurrent alarm) (1: valid; 0: invalid)	
Address	Address 3				Address 4					
Content	H16				L16					
	INT32									
	B31			B14	B13	...	B2	B1	B0	
	Associated with the alarm number 63 of the first group (DI2 alarm)					...and so on			Associated with the alarm number 32 of the first group (Alarm of over reactive power)	
Address	Address 5				Address 6					
Content	H16				L16					
	INT32									
	B31	...	B6	B5	B4	B3	B2	B1	B0	
		...		Associated first group alarm No. 69(Fourth channel temperature alarm)					Associated with the alarm number 64 of the first group (DI3 alarm)	
Address	Address 7				Address 8					
Content	H16				L16					
	INT32									
	B31				B30	B29	...	B2	B1	B0
	Associated with the alarm number 31 of the second group (Alarm of over active power)						...and so on			Associated with the alarm number 0 of the second group (phase A overcurrent alarm)
Address	Address 9				Address 10					
Content	H16				L16					
	INT32									
	B31				B14	B13	...	B2	B1	B0
	Associated with the alarm number 63 of the second group (DI2 alarm)						...and so on			Associated with the alarm number 31 of the second group (Alarm of over reactive power)
Address	Address 11				Address 12					
Content	H16				L16					
	INT32									
	B31	...	B6	B1	B4	B3	B2	B1	B0	
		...		Associated second group alarm No.					Associated with the alarm number 64 of the second	

				69(Fourth channel temperature alarm)					group (DI3 alarm)
--	--	--	--	--------------------------------------	--	--	--	--	-------------------

Take reading the associated alarm settings of DO1 (2590-2601) as an example, the read-out value is 0x0000 0x0007 0x0000 0x0000 0x0000 0x0000 0x0000 0x0000 0x0000 0x0000

Address	2590				2591			
	H16				L16			
	INT32							
	B31	B30	B29	...	B2	B1	B0	
	0	0	0	0	1	1	1	
Content	Associated with the alarm number 31 of the first group (Alarm of over active power)		and so on		Associated with the alarm number 0 of the first group (phase A overcurrent alarm)	

The remaining addresses in this example are all 0 and are no longer listed.

If the current DO1 function is controlled by the alarm of the first group, in this example, DO1 is associated with the phase A overcurrent alarm, the phase B overcurrent alarm, and the phase C overcurrent alarm of the first group.

9 Ethernet Communication Guide

9.1 Ethernet Parameter Modification

9.1.1 Modification by Button

Refer to 7.5 Network Settings of System Settings

9.1.2 Modification by Modbus Communication

Follow these steps to modify the Ethernet parameters:

- 1) Send the command 0xABCD to the register with the address 29 to enter the Ethernet setting mode; Send the command 0 to the register with the address 29 to exit the Ethernet setting mode, and the modified parameters are not saved at this time.
- 2) The new value can be written to the register after entering the Ethernet setting mode. If the Ethernet mode is not entered, the modification is invalid.
- 3) Send the command 0XABCD to the the register with the address 37 to save the changes. After it is written successfully, the Ethernet module enters the restart mode. After the Ethernet module restarts successfully, the host can read the Ethernet parameters correctly.

9.1.3 Modification by Web Pages

Local network settings

Firstly, enter the operating system (take win7 as an example), use the mouse to click on the network icon on the bottom right corner, click on "Open Network and Sharing Center", click on the change adapter settings, right-click the local connection, click properties, double-click Internet Protocol Version 4 (TCP / IPv4), you will see the page shown below. Please follow the instructions, select "Use the following IP address", and fill in the IP address 192.168.1.110 (the same subnet), the subnet mask 255.255.255.0, the default gateway 192.168.1.1 (The DNS part can be left blank). Click OK on the page and click OK on the Local Area Connection Properties page to wait for system to complete configuration.

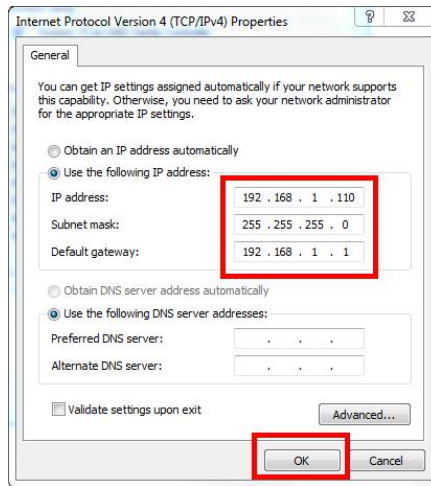

Connect the Ethernet module and the computer with a twisted-pair B cable, power the meter. If the local connection on the bottom right corner of the computer monitor is connected at this point, you can continue to the next step. Otherwise, power off the meter, check the network cable and network settings.

WEB page configuration

Open Internet Explorer, enter the Ethernet IP address in the address bar (http://192.168.1.150/, factory default setting), and the login screen shown in the figure below will appear.

Parameter	Minimum	Present	Maximum
Load Current (A)			
Ia	0.000	0.000	0.000
Ib	0.000	0.000	0.000
Ic	0.000	0.000	0.000
Voltage, L-N(V)			
Ua	0.0	0.0	0.0
Ub	0.0	0.0	0.0
Uc	0.0	0.0	0.0
Voltage, L-L(V)			
Uab	0.0	0.0	0.0
Ubc	0.0	0.0	0.0
Uca	0.0	0.0	0.0
Power Real (W)			
Pa	0.05	0.05	0.05
Pb	0.05	0.05	0.05
Pc	0.05	0.05	0.05
PT Power	0.05	0.05	0.05
Reactive (VAR)			
Qa	0.05	0.05	0.05
Qb	0.05	0.05	0.05
Qc	0.05	0.05	0.05
QT	0.05	0.05	0.05
Power Apparent (VA)			
Sa	0.05	0.05	0.05
Sb	0.05	0.05	0.05
Sc	0.05	0.05	0.05
ST	0.05	0.05	0.05
Power Factor			
PFa	0.000	1.000	1.000
PFb	0.000	1.000	1.000
PFc	0.000	1.000	1.000
PF	0.400	1.000	1.000
Frequency (Hz)	0.00	0.00	0.00

Click Setup to enter the Ethernet & TCP/IP configuration interface, as shown below:

After the modification is completed, click Apply to wait for it to take effect.

9.2 Extension of RS485 Communication

Extended 485 communication does not support the DLT-645 protocol and only supports the Modbus-RTU protocol.

9.2.1 Extending RS485 Communication as a Modbus Slave Station

When the second communication serves as a slave station, as the first channel RS485 communication, only supports the 0x03 command and does not support the 0x10 command. Refer to Chapter 8 for the address table.

9.2.2 Modbus TCP communication (Using ModScan software)

When using the Ethernet Modbus_TCP protocol, it supports 0x01 (read coil status), 0x02 (read input status), 03 (read hold register), 0x05 (write single coil). (Note: When using the 01, 02, and 05 commands, they all correspond to the APM8xx meter's own information. DI1 and DO1 correspond to the starting address 0.)

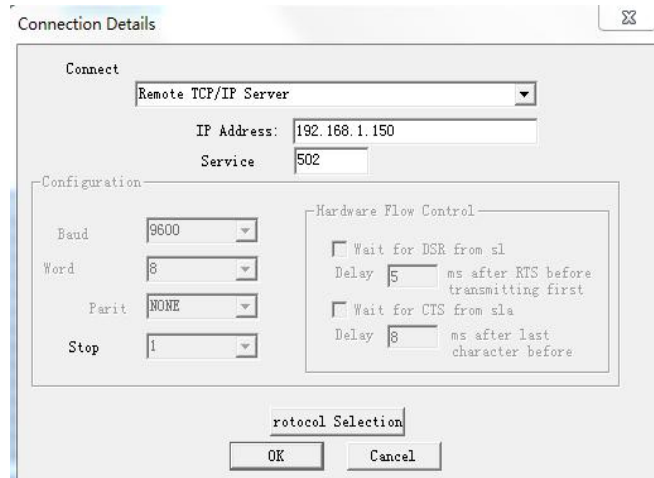

The contents of the following address table are for Modbus TCP operation only. (Related to the slave information read by the user)

Register (WORD)	Name	Resolution	Data type (Read-write attribute)	Note
39992-39993	Group 32-1 slave status		Int32 (RO)	The high byte is first, the low byte is after, bit0 is the first group state, and 1 is the read failure, and the corresponding cache is cleared.
39994-39995	Group 64-33 slave status		Int32 (RO)	The same as above
39996-39997	Group 96-65 slave status		Int32 (RO)	The same as above
39998-39999	Group 128-97 slave status		Int32 (RO)	The same as above
40000-57999	Information area read from slave station		RO	Example is as follow
58000	Read slave station timeout	1ms	UInt16(RW)	Example is as follow
58001	Slave station access interval time	1ms	UInt16(RW)	Example is as follow
58002	Group 1 slave station address		UInt16(RW)	1-247 (Slave address station, does not take effect when set to 0)
58003	Group 1 communication start address		UInt16(RW)	0-65535
58004	Group 1 communication length		UInt16(RW)	(Does not take effect when set to 0)
58005-58385	Group 2-128 slave station settings		UInt16(RW)	Same as 58002-58004
58386-58399	Reserved			
58400-58527	Failure rate		UInt16(RO)	Communication reads state of each group, the slave access failure rate of last 20 visits, 100% means the disconnection and clear cache

58600-58728	Number of errors		UInt16(RO)	The cumulative number of failures used to debug slave access
58800-58928	Number of transmissions		UInt16(RO)	The cumulative number of transmissions used to debug slave access

E.g:

The settings are as follows: The first group slave station address is 1, the start address is set to 0, the communication length is 125, the second group slave station address is 2, the start address is 20, and the communication length is 125, the read information area 40000-40124 corresponds to the information of the first group of slave station addresses 0-125, 40125-40249 corresponds to the information of the second group of slaves station 20-144, and so on, when the communication length of the 128 groups of devices is 125, the corresponding information area is 40000 -55999. If fail to read the information from the slave station, the read information area corresponding to the slave station is 0.

Baud rate (bps)	Read slave station timeout (Recommended setting time)	Slave station access interval time (recommended setting time)
1200	2500ms	10-20ms
2400	2000ms	10-20ms
4800	1500ms	10-20ms
≥9600	1000ms	10-20ms

9.2.3 Extending RS485 Communication as modbus Master

When the extended communication is used as a master station, a small serial port server can be implemented in conjunction with the Ethernet interface.

Extended serial port parameter configuration

Method 1:

Refer to bus1 in the communication settings of 7.5 system settings to modify the parameters of bus2.

Method 2:

According to the operation method of 9.1.3, after connecting the Ethernet module, click Setup->Serial Port to enter the serial port setting, and set the baud rate, check digit and response time. Click Apply when you are done to wait for it to take effect. As shown below:

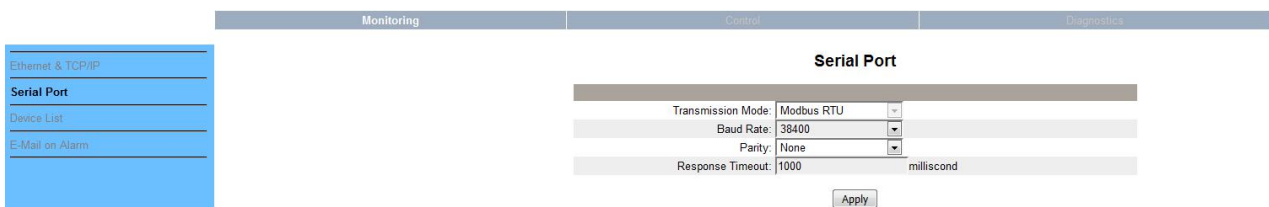

Modbus master parameter reading

According to the operation method of 9.1.3, after connecting the Ethernet module, click Setup->Device List to enter the Modbus master parameter reading, as shown below.

1. Number of Viewable: Users can configure up to 128 groups of 03 read commands of slaves.
2. Local ID: Meter Slave Address
3. Starting Register: Start Register Address
4. Number Of Register: The length of the register.

Note: If you need to modify the above parameters, please refer to 9.2.2 to modify the settings with the corresponding address by Modbus-TCP. After the 9.2.2 setting is completed, click Device List to refresh again.

The module will read the data from the slave according to this configuration. The read data is stored in registers starting with address 40000, which can be read by Modbus-Tcp.

For example: Read by Modbus-Tcp, the first one is to read 10 data starting from register 0 with slave address 1 and read 40000-40009, the second is to read 10 data starting from register 0 with slave address 2, read 40010-40019, and so on.

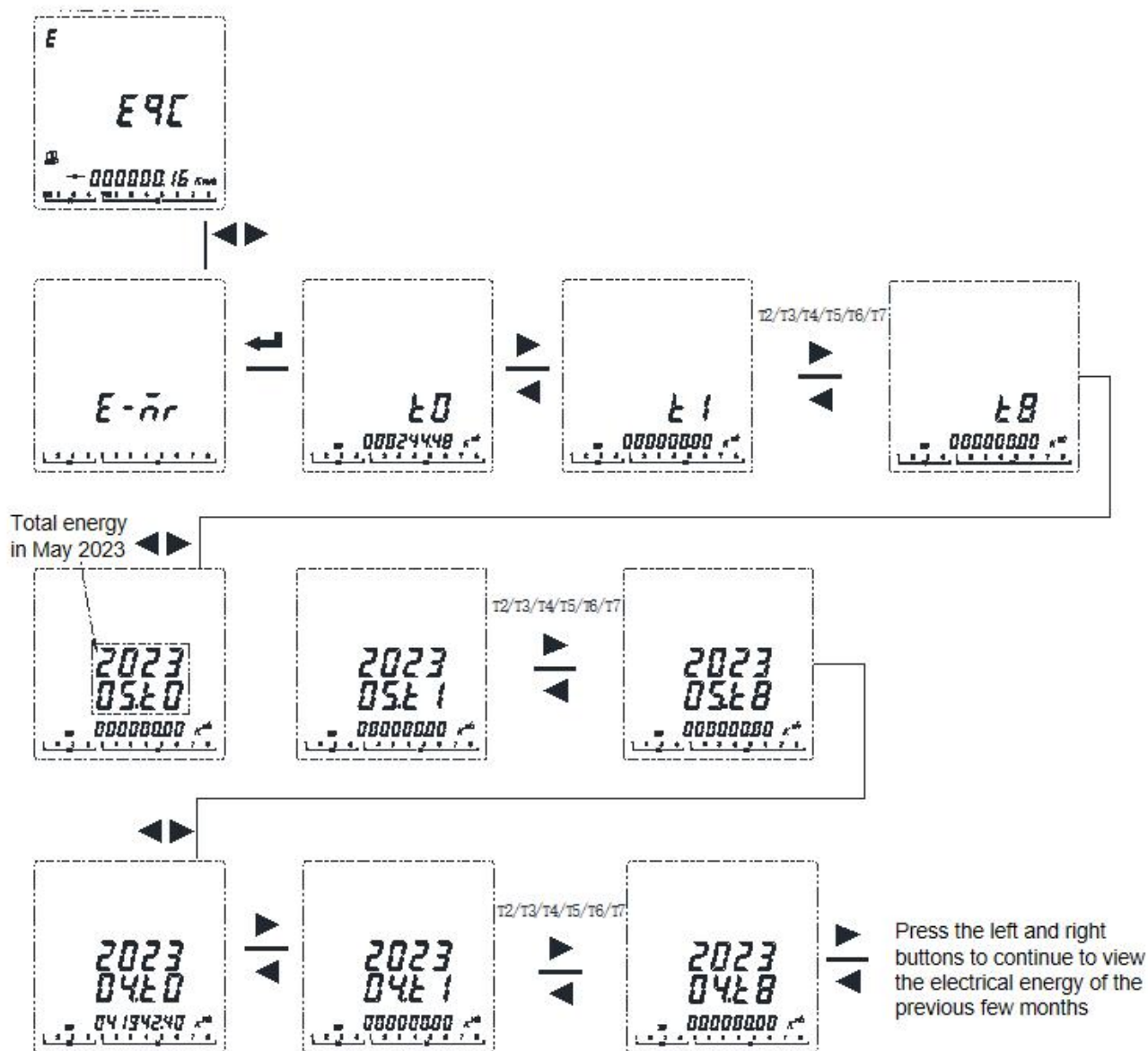

10.2 Multiple Rate Setting

Refer to Chapter 7 Parameter Setting to enter the setting mode.

Multiple rate rate setting

1. Press < ▶ > key until COST is selected, and then press the <ENTER> key.

2. Press < ▶ > key until Rate is selected, and then Press the <ENTER> key.

3. Press < ▶ > Key, select the time zone you want to modify (such as ZONE 1, which represents the first time zone), and then press the <ENTER> key.

4. Press < ▶ > Key, select the time period to modify, totaling 10 time periods, and then press the <ENTER> key.

5. Press < ▶ > Key, select the rate for the current period (the rate can be set to T1 (tip), T2 (peak), T3 (flat), T4 (valley), T5 (deep valley), T6 (reserved), T7 (reserved), T8 (reserved)), and press the <ENTER> key.

6. When setting the start time of the period, press the <ENTER> key.

7. Set the starting time of the period and press the <ENTER> key.

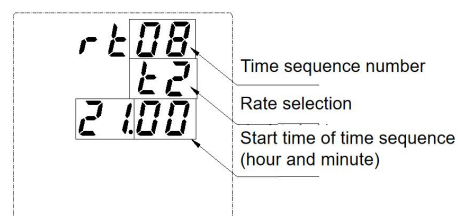

8. Repeat step 4 to modify other time periods, as detailed in the table below.

9. Press the<ESC>key to return to the COST interface.

SN	Rate	Time	Description
1	3	00.00	During the period from 00:00 to 03:00, the rate is T3 (flat)
2	2	03.00	During the period from 03:00 to 06:00, the rate is T2 (peak)
3	2	06.00	During the period from 06:00 to 09:00, the rate is T2 (peak)
4	1	09.00	During the period from 09:00 to 12:00, the rate is T1 (tip)
5	2	12.00	During the period from 12:00 to 15:00, the rate is T2 (peak)
6	1	15.00	During the period from 15:00 to 18:00, the rate is T1 (tip)
7	2	18.00	During the period from 18:00 to 21:00, the rate is T2 (peak)
8	2	21.00	During the period from 21:00 to 22:00, the rate is T2 (peak)
9	2	22.00	During the period from 22:00 to 23:00, the rate is T2 (peak)
10	2	23.00	During the period from 23:00 to 24:00, the rate is T2 (peak)

Note: When manually setting or writing the rate period through communication, it is necessary to ensure that the time set for the next period is greater than the time set for the previous period.

Multiple rate time zone selection settings

1. Press< ▶ > key until COST is selected, and then press the<ENTER>key

2. Press< ▶ > key until SEL (time zone selection) is selected,

and then press the <ENTER>key.

3. Press< ▶ > Key, select the SEG (6 segments in total) that you

want to modify (such as SEG.1, which represents the first segment), and then press the<ENTER>key.

4. Set the time zone (TZ, Time Zone), with 4 optional time zones.

Press the<ENTER>key.

5. Set the start date month and press the<ENTER>key.

6. Set the start date by pressing the<ENTER>key.

7. Repeat step three to modify other time periods. Please refer to the table below for a detailed description.

8. Press the<ESC>key until you return to the COST interface.

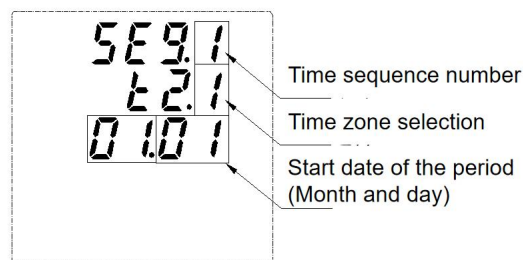

SN	Zone	Time	Description
1	1	01.01	Indicates that from January 1st to February 1st, time zone 1 is used to calculate the compound rate electricity energy
2	1	02.01	Indicates that from February 1st to April 1st, time zone 1 is used to calculate the compound rate electricity energy
3	2	04.01	Indicates that from April 1st to June 1st, time zone 2 is used to calculate the compound rate electricity energy
4	3	06.01	Indicates that from June 1st to August 1st, time zone 3 is used to calculate the compound rate electricity energy
5	4	08.01	Indicates that from August 1st to October 1st, time zone 4 is used to calculate the compound rate electricity energy
6	4	10.01	Indicates that from October 1st to January 1st, time zone 4 is used to calculate the compound rate electricity energy

Note: When manually setting or writing communication time periods, it is necessary to ensure that the date set for the next time period is greater than the date set for the previous time period.

10.3 Multiple rate electrical energy communication address table

Eight rate address table: (T1 tip , T2 peak, T3 flat, T4 valley, T5 deep valley, T6-T8 temporarily reserved)

Register (WORD)	Name	Resolution	Data Type (Read Write Attribute)	Remarks
7728	Total positive active energy (T)	1WH	Uint32 (RO)	Secondary side electrical energy
772A	Total positive active tip energy (T1)	1WH	Uint32 (RO)	Secondary side electrical energy
772C	Total positive active peak energy (T2)	1WH	Uint32 (RO)	Secondary side electrical energy
772E	Total positive active flat energy (T3)	1WH	Uint32 (RO)	Secondary side electrical energy
7730	Total positive active valley energy (T4)	1WH	Uint32 (RO)	Secondary side electrical energy
7732	Total positive active deep valley energy (T5)	1WH	Uint32 (RO)	Secondary side electrical energy
7734	Reserved(T6)	1WH	Uint32 (RO)	Secondary side electrical energy
7736	Reserved(T7)	1WH	Uint32 (RO)	Secondary side electrical energy
7738	Reserved(T8)	1WH	Uint32 (RO)	Secondary side electrical energy
773A	Total positive active energy of this month (T)	1WH	Uint32 (RO)	Secondary side electrical energy
773C	Total positive active tip energy of this month (T1)	1WH	Uint32 (RO)	Secondary side electrical energy
773E	Total positive active peak energy of this month(T2)	1WH	Uint32 (RO)	Secondary side electrical energy
7740	Total positive active flat energy of this month(T3)	1WH	Uint32 (RO)	Secondary side electrical energy
7742	Total positive active valley energy of this month(T4)	1WH	Uint32 (RO)	Secondary side electrical energy
7744	Total positive active deep valley energy of this month(T5)	1WH	Uint32 (RO)	Secondary side electrical energy
7746	Reserved(T6)	1WH	Uint32 (RO)	Secondary side electrical energy
7748	Reserved(T7)	1WH	Uint32 (RO)	Secondary side electrical energy
774A	Reserved(T8)	1WH	Uint32 (RO)	Secondary side electrical energy
7824	Total reversed active energy (T)	1WH	Uint32 (RO)	Secondary side electrical energy
7826	Total reversed active tip energy (T1)	1WH	Uint32 (RO)	Secondary side electrical energy
7828	Total reverse active peak energy (T2)	1WH	Uint32 (RO)	Secondary side electrical energy
782A	Total reverse active flat energy (T3)	1WH	Uint32 (RO)	Secondary side electrical energy
782C	Total reverse active valley energy (T4)	1WH	Uint32 (RO)	Secondary side electrical energy
782E	Total reverse active deep valley energy (T5)	1WH	Uint32 (RO)	Secondary side electrical energy
7830	Reserved(T6)	1WH	Uint32 (RO)	Secondary side electrical energy
7832	Reserved(T7)	1WH	Uint32 (RO)	Secondary side electrical energy
7834	Reserved(T8)	1WH	Uint32 (RO)	Secondary side electrical energy
7836	Total reverse active energy of this month (T)	1WH	Uint32 (RO)	Secondary side electrical energy
7838	Total reverse active tip energy of this month (T)	1WH	Uint32 (RO)	Secondary side electrical energy
783A	Total reverse active peak energy of this	1WH	Uint32 (RO)	Secondary side electrical energy

	month (T)				
783C	Total reverse active flat energy of this month (T)	1WH	Uint32 (RO)	Secondary side electrical energy	
783E	Total reverse active valley energy of this month (T)	1WH	Uint32 (RO)	Secondary side electrical energy	
7840	Total reverse active deep valley energy of this month (T)	1WH	Uint32 (RO)	Secondary side electrical energy	
7842	Reserved(T6)	1WH	Uint32 (RO)	Secondary side electrical energy	
7844	Reserved(T7)	1WH	Uint32 (RO)	Secondary side electrical energy	
7846	Reserved(T8)	1WH	Uint32 (RO)	Secondary side electrical energy	
7530	Total positive active energy (T)	1WH	Float (RO)	Primary side electrical energy	
7532	Total positive active tip energy (T1)	1WH	Float (RO)	Primary side electrical energy	
7534	Total positive active peak energy (T1)	1WH	Float (RO)	Primary side electrical energy	
7536	Total positive active flat energy (T1)	1WH	Float (RO)	Primary side electrical energy	
7538	Total positive active valley energy (T1)	1WH	Float (RO)	Primary side electrical energy	
753A	Total positive active deep valley energy (T1)	1WH	Float (RO)	Primary side electrical energy	
753C	Reserved(T6)	1WH	Float (RO)	Primary side electrical energy	
753E	Reserved(T7)	1WH	Float (RO)	Primary side electrical energy	
7540	Reserved(T8)	1WH	Float (RO)	Primary side electrical energy	
7542	Total positive active energy of this month (T)	1WH	Float (RO)	Primary side electrical energy	
7544	Total positive active tip energy of this month (T1)	1WH	Float (RO)	Primary side electrical energy	
7546	Total positive active peak energy of this month (T2)	1WH	Float (RO)	Primary side electrical energy	
7548	Total positive active flat energy of this month (T3)	1WH	Float (RO)	Primary side electrical energy	
754A	Total positive active valley energy of this month (T4)	1WH	Float (RO)	Primary side electrical energy	
754C	Total positive active deep valley energy of this month (T5)	1WH	Float (RO)	Primary side electrical energy	
754E	Reserved(T6)	1WH	Float (RO)	Primary side electrical energy	
7550	Reserved(T7)	1WH	Float (RO)	Primary side electrical energy	
7552	Reserved(T8)	1WH	Float (RO)	Primary side electrical energy	
7554	History January energy	Total positive active energy (T)	1WH	Float (RO)	Primary side electrical energy
7556		Total positive active tip energy (T1)	1WH	Float (RO)	Primary side electrical energy
7558		Total positive active peak energy (T2)	1WH	Float (RO)	Primary side electrical energy
755A		Total positive active flat energy (T3)	1WH	Float (RO)	Primary side electrical energy
755C		Total positive active valley energy (T4)	1WH	Float (RO)	Primary side electrical energy
755E		Total positive active deep	1WH	Float (RO)	Primary side electrical energy

		valley energy (T5)			
7560		Reserved(T6)	1WH	Float (RO)	Primary side electrical energy
7562		Reserved(T7)	1WH	Float (RO)	Primary side electrical energy
7564		Reserved(T8)	1WH	Float (RO)	Primary side electrical energy

7566	History February positive active energy	7578	History March positive active energy	758A	History April positive active energy
759C	History May positive active energy	75AE	History June positive active energy	75C0	History July positive active energy
75D2	History August positive active power	75E4	History September positive active energy	75F6	History October positive active power
7608	History November positive active power	761A	History December positive active power		

Register (WORD)	Name		Resolution	Data Type (Read Write Attribute)	Remarks
762C	Reverse total active energy (T)		1WH	Float (RO)	Primary side electrical energy
762E	Reverse total active tip energy (T1)		1WH	Float (RO)	Primary side electrical energy
7630	Reverse total active peak energy (T2)		1WH	Float (RO)	Primary side electrical energy
7632	Reverse total active flat energy (T3)		1WH	Float (RO)	Primary side electrical energy
7634	Reverse total active valley energy (T4)		1WH	Float (RO)	Primary side electrical energy
7636	Reverse total active deep valley energy (T5)		1WH	Float (RO)	Primary side electrical energy
7638	Reserved (T6)		1WH	Float (RO)	Primary side electrical energy
763A	Reserved (T7)		1WH	Float (RO)	Primary side electrical energy
763C	Reserved (T8)		1WH	Float (RO)	Primary side electrical energy
763E	Total reversed active energy of this month (T)		1WH	Float (RO)	Primary side electrical energy
7640	Total reversed active tip energy of this month (T1)		1WH	Float (RO)	Primary side electrical energy
7642	Total reversed active peak energy of this month (T2)		1WH	Float (RO)	Primary side electrical energy
7644	Total reversed active flat energy of this month (T3)		1WH	Float (RO)	Primary side electrical energy
7646	Total reversed active valley energy of this month (T4)		1WH	Float (RO)	Primary side electrical energy
7648	Total reversed active deep valley energy of this month (T5)		1WH	Float (RO)	Primary side electrical energy
764A	Reserved (T6)		1WH	Float (RO)	Primary side electrical energy
764C	Reserved (T7)		1WH	Float (RO)	Primary side electrical energy
764E	Reserved (T8)		1WH	Float (RO)	Primary side electrical energy
7650	History January	Reverse total active energy (T)	1WH	Float (RO)	Primary side electrical energy
7652	energy	Reverse tip active energy	1WH	Float (RO)	Primary side electrical energy

		(T1)			
7654		Reverse peak active energy (T2)	1WH	Float (RO)	Primary side electrical energy
7656		Reverse flat active energy (T3)	1WH	Float (RO)	Primary side electrical energy
7658		Reverse valley active energy (T4)	1WH	Float (RO)	Primary side electrical energy
765A		Reverse deep valley active energy (T5)	1WH	Float (RO)	Primary side electrical energy
765C		Reserved (T6)	1WH	Float (RO)	Primary side electrical energy
765E		Reserved (T7)	1WH	Float (RO)	Primary side electrical energy
7660		Reserved (T8)	1WH	Float (RO)	Primary side electrical energy

7662	History February reverse active energy	7674	History March reverse active energy	7686	History April reverse active energy
7698	History May reverse active energy	76AA	History June reverse active energy	76BC	History July reverse active energy
76CE	History August reverse active power	76E0	History September reverse active energy	76F2	History October reverse active power
7704	History November reverse active power	7716	History December reverse active power		

Register (WORD)	Name	Resolution	Data Type (Read Write Attribute)	Remarks
6600	The start time of the first period of the first set of re-rates		Int16 (RW)	High byte: hour; Byte number: minutes
6601-6609	The starting time of period 2-10 of the first set of re-rates			Ditto
6610-6619	The starting time of period 1-10 of the second set of re-rates			Ditto
6620-6629	The starting time of period 1-10 of the third set of re-rate			Ditto
6630-6639	The starting time of period 1-10 of the fourth set of repricing			Ditto
6640	The first set of rates for the first 1-2 time period rate selection		Int16 (RW)	High byte: Period 1 rate selection; Low byte: Period 2 rate selection. 0: tip energy (T1), 1: peak energy (T2), 2: flat energy (T3), 3: valley energy (T4), 4: deep valley electric energy (T5), the same below.
6641	The first set of multiple rates in the 3-4 time period rate choice		Int16 (RW)	High byte: period 3 rate selection; Low byte: Period 4 rate selection.
6642	The first set of multiple rates in the 5-6 time period rate choice		Int16 (RW)	High byte: Period 5 rate selection; Low byte: Period 6 rate selection.
6643	The first set of multiple rates in the 7-8 time period rate choice		Int16 (RW)	High byte: Period 7 rate selection; Low byte: Period 8 rate selection.

6644	The first set of multiple rates in the 9-10 time period rate choice		Int16 (RW)	High byte: Period 9 rate selection; Low byte: Period 10 rate selection.
6645	The second set of multiple rates in the 1-2 time period rate choice		Int16 (RW)	High byte: Period 1 rate selection; Low byte: Period 2 rate selection.
6646	The second set of multiple rates in the 3-4 time period rate choice		Int16 (RW)	High byte: period 3 rate selection; Low byte: Period 4 rate selection.
6647	The second set of multiple rates in the 5-6 time period rate choice		Int16 (RW)	High byte: Period 5 rate selection; Low byte: Period 6 rate selection.
6648	The second set of multiple rates in the 7-8 time period rate choice		Int16 (RW)	High byte: Period 7 rate selection; Low byte: Period 8 rate selection.
6649	The second set of multiple rates in the 9-10 time period rate choice		Int16 (RW)	High byte: Period 9 rate selection; Low byte: Period 10 rate selection.
6650	The third set of multiple rates in the 1-2 time period rate choice		Int16 (RW)	High byte: Period 1 rate selection; Low byte: Period 2 rate selection.
6651	The third set of multiple rates in the 3-4 time period rate choice		Int16 (RW)	High byte: period 3 rate selection; Low byte: Period 4 rate selection.
6652	The third set of multiple rates in the 5-6 time period rate choice		Int16 (RW)	High byte: Period 5 rate selection; Low byte: Period 6 rate selection.
6653	The third set of multiple rates in the 7-8 time period rate choice		Int16 (RW)	High byte: Period 7 rate selection; Low byte: Period 8 rate selection.
6654	The third set of multiple rates in the 9-10 time period rate choice		Int16 (RW)	High byte: Period 9 rate selection; Low byte: Period 10 rate selection.
6655	The fourth set of multiple rates in the 1-2 time period rate choice		Int16 (RW)	High byte: Period 1 rate selection; Low byte: Period 2 rate selection.
6656	The fourth set of multiple rates in the 3-4 time period rate choice		Int16 (RW)	High byte: period 3 rate selection; Low byte: Period 4 rate selection.
6657	The fourth set of multiple rates in the 5-6 time period rate choice		Int16 (RW)	High byte: Period 5 rate selection; Low byte: Period 6 rate selection.
6658	The fourth set of multiple rates in the 7-8 time period rate choice		Int16 (RW)	High byte: Period 7 rate selection; Low byte: Period 8 rate selection.
6659	The fourth set of multiple rates in the 9-10 time period rate choice		Int16 (RW)	High byte: Period 9 rate selection; Low byte: Period 10 rate selection.
6660	Time zone 1 start date		Int16 (RW)	High byte: month; Low byte: day
6661	Time zone 2 start date		Int16 (RW)	High byte: month; Low byte: day
6662	Time zone 3 start date		Int16 (RW)	High byte: month; Low byte: day
6663	Time zone 4 start date		Int16 (RW)	High byte: month; Low byte: day
6664	Time zone 5 start date		Int16 (RW)	High byte: month; Low byte: day
6665	Time zone 6 start date		Int16 (RW)	High byte: month; Low byte: day
6666	Time zone 1 & 2 rate selections		Int16 (RW)	High byte: 1st time zone multi-rate selection; Low byte: 2nd time zone multi-rate selection (same below) 0: first set of multi-rate, 1: second set of multi-rate 2: third set of multi-rate, 3: fourth set of multi-rate
6667	Time zone 3 and 4 rate selections		Int16 (RW)	High byte: 3rd time zone multi-rate selection;

				Low byte: 4th time zone multi-rate selection
6668	5th and 6th time zone rate selections		Int16 (RW)	High byte: 5th time zone multi-rate selection; Low byte: 6th time zone multi-rate selection

11 DL/T-645 Communication Guide

It mainly describes how to use the software to control the series of instruments through the communication port. Mastering the content requires you to have a knowledge base of the DL/T645-2007 agreement and read through all the other sections of this volume to gain a comprehensive understanding of the product features and application concepts. This chapter includes: DL/T645-2007 protocol brief, communication application format, local application details and parameter address table.

11.1 DL/T645-2007 Brief description of the agreement

The instrument uses a communication protocol conforming to the DL/T645-2007 specification. The DL/T645-2007 protocol defines the check code, data, sequence, etc., which are all necessary for specific data exchange. The DL/T645-2007 protocol uses a master-slave acknowledgment connection (half-duplex) on a single communication line, which means that signals are transmitted in opposite directions on a single communication line. First, the signal of the host computer is addressed to a unique terminal device (slave), and then the response signal from the terminal device is transmitted to the host in the opposite direction. Brief description of the agreement.

The DL/T645-2007 protocol only allows communication between the host (PC, PLC, etc.) and the terminal device, and does not allow data exchange between independent terminal devices, so that the terminal devices do not occupy the communication line when they initialize. It is limited to responding to the inquiry signal arriving at the unit.

11.2 transmission method

The transmission method refers to a series of independent data structures in a data frame and a limited rule for transmitting data. The following describes a transmission method compatible with the DL/T645-2007 protocol-RTU mode.

Bit per byte

1 start bit

8 data bits, the smallest valid bit is sent first

1 even parity

1 stop bit

Error checking and verification

11.3 protocol

When the data frame arrives at the terminal device, it enters the addressed device through a simple "port" that removes the "envelope" (data header) of the data frame, reads the data, and executes the data if there are no errors. The requested task, then it adds the data it generates to the obtained "envelope" and returns the data frame to the sender. The returned response data includes the following contents: the terminal slave address (Address), the executed command (Function), the requested data generated by the execution command (Data), and a check code (Check). No error will occur if any error occurs, or an error indication frame will be returned.

11.3.1 Data frame format

68H	A0	A1	A2	A3	A4	A5	68H	C	L	DI0	DI1	N1	...	Nm	CS	16H
Starter	Address field						Frame start	Control code	Data length	Data identification	data				Check code	Terminator

a) Frame starter 68H

Identifies the beginning of a frame of data, the value is 68H

b) Address field A0~A5

The address field consists of 6 bytes (8-bit binary code) with 2 bits of BCD code per byte. The address length can be up to 12 decimal digits. These bits indicate the address of the user-specified terminal device that will receive the host data

from it. The address of each terminal device must be unique, and only the addressed terminal will respond to the query containing the address. When the terminal sends back a response, the slave address data in the response tells the host which terminal is communicating with it. When the address is 999999999999H, it is the broadcast address. Valid only for special commands, such as broadcast time, broadcast freeze, etc. The broadcast command does not require a slave to answer.

When the address field is transmitted, the low byte is first and the high byte is after.

c)Control code C

The function field code tells the terminal which is being addressed which function to perform. The table below lists the function codes used in this series of instruments, as well as their meaning and function.

Code	significance	behavior
11H	Reading data	Read data from APM Series meters
91H	Read data response	APM series instrument response to read data
14H	Write data	Write data to APM
94H	Write data response	APM series instrument response to write data
D4H 或 D1H	Error response	Received data error

d) Data field (data identification and data) length L

The byte length of the data field. When reading data, $L \leq 200$, when writing data, $L \leq 50$, when $L=0$, it means no data field.

e)Data field DATA

The data field includes data identification, password, operator code, data, frame number, etc., and its structure changes with the function of the control code. When transmitting, the sender adds 33H to the byte, and the receiver subtracts 33H by byte.

f)Error check CS

The sum of the modulo 256 of all bytes from the start of the frame start to the check code, that is, the binary arithmetic sum of each byte, excluding the overflow value exceeding 256.

g) End character 16H

Identify the end of a frame of data

11.3.2 transmission

a)Leading byte

Before sending frame information, you can transmit 1 to 4 bytes of FEH to wake up the receiver.

b)Transmission order

All data items are transmitted first with the low byte and then with the high byte. The transmitted data item (except the switching amount) is the compressed BCD code of the actual data plus 33H. If the external host reads the positive active energy of the APM series meter, the meter address is 1:

Host sending: FE FE 68 01 00 00 00 00 00 68 11 04 33 33 34 33 B3 16

APM Series instrument response(15.82kWh): 68 01 00 00 00 00 00 68 91 08 33 33 34 33 B5 48 33 33 9A 16

c) Transmission response rate

Each communication is initiated by the primary station transmitting a request command frame to the slave selected by the information frame address field, and the requested slave responds according to the requirements of the control code in the command frame.

Response delay after receiving the command frame: $\leq 500\text{ms}$

Pause time between bytes: ≤ 6 bytes of transmission time, when this time is exceeded, the APM series instrument considers it a new data frame

d)Error control

The byte check is even parity, and the frame check is a vertical information checksum. The receiver abandons the information frame regardless of whether an even check or a vertical information checksum error is detected, and does not respond.

e) Transmission rate

initial rate: 9600bps

set to: 1200、2400、4800、9600、19200bps

11.3.3 Data identification table

variable name	Send a sample (using address 1 as an example, the user can set according to actual needs, the address high is filled with "00000000")	Return bytes	Return data format (secondary)	Return data unit
Phase A voltage	68 01 00 00 00 00 00 68 11 04 33 34 34 35 B6 16	2	XXX.X	V
Phase B voltage	68 01 00 00 00 00 00 68 11 04 33 35 34 35 B7 16	2	XXX.X	V
Phase C voltage	68 01 00 00 00 00 00 68 11 04 33 36 34 35 B8 16	2	XXX.X	V
Read voltage data block	68 01 00 00 00 00 00 68 11 04 33 32 34 35 B4 16	2*3	XXX.X	V
Phase A current	68 01 00 00 00 00 00 68 11 04 33 34 35 35 B7 16	3	XXX.XXX	A
Phase B current	68 01 00 00 00 00 00 68 11 04 33 35 35 35 B8 16	3	XXX.XXX	A
Phase C current	68 01 00 00 00 00 00 68 11 04 33 36 35 35 B9 16	3	XXX.XXX	A
Read current block	68 01 00 00 00 00 00 68 11 04 33 32 35 35 B5 16	3*3	XXX.XXX	A
Total active power	68 01 00 00 00 00 00 68 11 04 33 33 36 35 B7 16	3	XX.XXXX	kW
Phase A active power	68 01 00 00 00 00 00 68 11 04 33 34 36 35 B8 16	3	XX.XXXX	kW
Phase B active power	68 01 00 00 00 00 00 68 11 04 33 35 36 35 B9 16	3	XX.XXXX	kW
Phase C active power	68 A0 00 00 00 00 00 68 11 04 33 36 36 35 BA 16	3	XX.XXXX	kW
Active power data block	68 01 00 00 00 00 00 68 11 04 33 32 36 35 B6 16	3*4	XX.XXXX	kW
Total reactive power	68 01 00 00 00 00 00 68 11 04 33 33 37 35 B8 16	3	XX.XXXX	kvar
Phase A reactive power	68 01 00 00 00 00 00 68 11 04 33 34 37 35 B9 16	3	XX.XXXX	kvar
Phase B reactive power	68 01 00 00 00 00 00 68 11 04 33 35 37 35 BA 16	3	XX.XXXX	kvar
Phase C reactive power	68 01 00 00 00 00 00 68 11 04 33 36 37 35 BB 16	3	XX.XXXX	kvar
Reactive power data block	68 01 00 00 00 00 00 68 11 04 33 32 37 35 B7 16	3*4	XX.XXXX	kvar
Total apparent power	68 01 00 00 00 00 00 68 11 04 33 33 38 35 B9 16	3	XX.XXXX	kVA
A phase apparent power	68 01 00 00 00 00 00 68 11 04 33 34 38 35 BA 16	3	XX.XXXX	kVA
B phase apparent power	68 01 00 00 00 00 00 68 11 04 33 35 38 35 BB 16	3	XX.XXXX	kVA
C phase apparent power	68 01 00 00 00 00 00 68 11 04 33 36 38 35 BC 16	3	XX.XXXX	kVA
Apparent power block	68 01 00 00 00 00 00 68 11 04 33 32 38 35 B8 16	3*4	XX.XXXX	kVA
Power factor	68 01 00 00 00 00 00 68 11 04 33 33 39 35 BA 16	2	X.XXX	
Phase A power factor	68 01 00 00 00 00 00 68 11 04 33 34 39 35 BA 16	2	X.XXX	
Phase B power factor	68 01 00 00 00 00 00 68 11 04 33 35 39 35 BA 16	2	X.XXX	
Phase C power factor	68 01 00 00 00 00 00 68 11 04 33 36 39 35 BA 16	2	X.XXX	
Power factor block	68 01 00 00 00 00 00 68 11 04 33 32 39 35 B9 16	2*4	X.XXX	
Total active energy	68 01 00 00 00 00 00 68 11 04 33 33 33 33 B2 16	4	XXXXXX. XX	kWh
Positive active energy	68 01 00 00 00 00 00 68 11 04 33 33 34 33 B3 16	4	XXXXXX. XX	kWh
Reverse active energy	68 01 00 00 00 00 00 68 11 04 33 33 35 33 B4 16	4	XXXXXX. XX	kWh

Inductive reactive energy	68 01 00 00 00 00 00 68 11 04 33 33 36 33 B5 16	4	XXXXXX. XX	kvarh
Capacitive reactive energy	68 01 00 00 00 00 00 68 11 04 33 33 37 33 B6 16	4	XXXXXX. XX	kvarh
Four quadrant energy data block	68 01 00 00 00 00 00 68 11 04 33 33 32 33 B1 16	4*5	XXXXXX. XX	kWh/ kvarh
Positive active multiple rate total energy	68 01 00 00 00 00 00 68 11 04 33 33 34 33 B3 16	4	XXXXXX. XX	kWh
Positive active rate	68 01 00 00 00 00 00 68 11 04 33 34 34 33 B4 16	4	XXXXXX. XX	kWh
Positive active complex rate peak energy	68 01 00 00 00 00 00 68 11 04 33 35 34 33 B5 16	4	XXXXXX. XX	kWh
Positive active multi-rate Flat electric energy	68 01 00 00 00 00 00 68 11 04 33 36 34 33 B6 16	4	XXXXXX. XX	kWh
Positive active multi-rate Valley power	68 01 00 00 00 00 00 68 11 04 33 37 34 33 B7 16	4	XXXXXX. XX	kWh
Current positive active energy data block	68 01 00 00 00 00 00 68 11 04 33 32 34 33 B2 16	4*5	XXXXXX. XX	kWh
Last January, positive reactive power, total energy	68 01 00 00 00 00 00 68 11 04 34 33 34 33 B4 16	4	XXXXXX. XX	kWh
Last January, positive reactive rate, sharp energy	68 01 00 00 00 00 00 68 11 04 34 34 34 33 B5 16	4	XXXXXX. XX	kWh
Positive power rate peak power in January	68 01 00 00 00 00 00 68 11 04 34 35 34 33 B6 16	4	XXXXXX. XX	kWh
Last January, positive reactive rate, flat energy	68 01 00 00 00 00 00 68 11 04 34 36 34 33 B7 16	4	XXXXXX. XX	kWh
Last January, positive active rate, valley energy	68 01 00 00 00 00 00 68 11 04 34 37 34 33 B8 16	4	XXXXXX. XX	kWh
Positive active energy data block in January	68 01 00 00 00 00 00 68 11 04 34 32 34 33 B3 16	4*5	XXXXXX. XX	kWh
Last February, positive reactive power, total energy	68 01 00 00 00 00 00 68 11 04 35 33 34 33 B5 16	4	XXXXXX. XX	kWh
Last February, positive active rate, sharp energy	68 01 00 00 00 00 00 68 11 04 35 34 34 33 B6 16	4	XXXXXX. XX	kWh
Last February, positive active rate, peak energy	68 01 00 00 00 00 00 68 11 04 35 35 34 33 B7 16	4	XXXXXX. XX	kWh
Last February, positive active rate, flat energy	68 01 00 00 00 00 00 68 11 04 35 36 34 33 B8 16	4	XXXXXX. XX	kWh
Last February, positive active rate, valley energy	68 01 00 00 00 00 00 68 11 04 35 37 34 33 B9 16	4	XXXXXX. XX	kWh
Last February Positive active energy data block	68 01 00 00 00 00 00 68 11 04 35 32 34 33 B4 16	4*5	XXXXXX. XX	kWh
Last March, the positive energy rate , total energy	68 01 00 00 00 00 00 68 11 04 36 33 34 33 B6 16	4	XXXXXX. XX	kWh
Last March, positive active rate, sharp energy	68 01 00 00 00 00 00 68 11 04 36 34 34 33 B7 16	4	XXXXXX. XX	kWh
Last March, positive active rate	68 01 00 00 00 00 00 68 11 04 36 35 34 33 B8 16	4	XXXXXX. XX	kWh

peak energy			XX	
Last March, positive active rate, flat energy	68 01 00 00 00 00 00 68 11 04 36 36 34 33 B9 16	4	XXXXXXX. XX	kWh
Last March, positive active rate, valley energy	68 01 00 00 00 00 00 68 11 04 36 37 34 33 BA 16	4	XXXXXXX. XX	kWh
Last March Positive active energy data block	68 01 00 00 00 00 00 68 11 04 36 32 34 33 B5 16	4*5	XXXXXXX. XX	kWh
Last April, the positive energy rate total energy	68 01 00 00 00 00 00 68 11 04 37 33 34 33 B7 16	4	XXXXXXX. XX	kWh
Last April, positive active rate, sharp energy	68 01 00 00 00 00 00 68 11 04 37 34 34 33 B8 16	4	XXXXXXX. XX	kWh
Last April, positive active rate peak energy	68 01 00 00 00 00 00 68 11 04 37 35 34 33 B9 16	4	XXXXXXX. XX	kWh
Last April, positive active rate, flat energy	68 01 00 00 00 00 00 68 11 04 37 36 34 33 BA 16	4	XXXXXXX. XX	kWh
Last April, positive active rate, valley energy	68 01 00 00 00 00 00 68 11 04 37 37 34 33 BB 16	4	XXXXXXX. XX	kWh
Last April Positive active energy data block	68 01 00 00 00 00 00 68 11 04 37 32 34 33 B6 16	4*5	XXXXXXX. XX	kWh
Last May, positive energy rate , total energy	68 01 00 00 00 00 00 68 11 04 38 33 34 33 B8 16	4	XXXXXXX. XX	kWh
Last May, positive active rate, sharp energy	68 01 00 00 00 00 00 68 11 04 38 34 34 33 B9 16	4	XXXXXXX. XX	kWh
Last May, positive active rate peak energy	68 01 00 00 00 00 00 68 11 04 38 35 34 33 BA 16	4	XXXXXXX. XX	kWh
Last May, positive active rate, flat energy	68 01 00 00 00 00 00 68 11 04 38 36 34 33 BB 16	4	XXXXXXX. XX	kWh
Last May, positive active rate, valley energy	68 01 00 00 00 00 00 68 11 04 38 37 34 33 BC 16	4	XXXXXXX. XX	kWh
Last May Positive active energy data block	68 01 00 00 00 00 00 68 11 04 38 32 34 33 B7 16	4*5	XXXXXXX. XX	kWh
Last June, the positive energy rate total energy	68 01 00 00 00 00 00 68 11 04 39 33 34 33 B9 16	4	XXXXXXX. XX	kWh
Last June, positive active rate, sharp energy	68 01 00 00 00 00 00 68 11 04 39 34 34 33 BA 16	4	XXXXXXX. XX	kWh
Last June, positive active rate peak energy	68 01 00 00 00 00 00 68 11 04 39 35 34 33 BB 16	4	XXXXXXX. XX	kWh
Last June, positive active rate, flat energy	68 01 00 00 00 00 00 68 11 04 39 36 34 33 BC 16	4	XXXXXXX. XX	kWh
Last June, positive active rate, valley energy	68 01 00 00 00 00 00 68 11 04 39 37 34 33 BD 16	4	XXXXXXX. XX	kWh
Last June Positive active energy data block	68 01 00 00 00 00 00 68 11 04 39 32 34 33 B8 16	4*5	XXXXXXX. XX	kWh
Last July, the positive energy rate total energy	68 01 00 00 00 00 00 68 11 04 3A 33 34 33 BA 16	4	XXXXXXX. XX	kWh
Last July, positive active rate, sharp energy	68 01 00 00 00 00 00 68 11 04 3A 34 34 33 BB 16	4	XXXXXXX. XX	kWh

Last July, positive active rate peak energy	68 01 00 00 00 00 00 68 11 04 3A 35 34 33 BC 16	4	XXXXXX. XX	kWh
Last July, positive active rate, flat energy	68 01 00 00 00 00 00 68 11 04 3A 36 34 33 BD 16	4	XXXXXX. XX	kWh
Last July, positive active rate, valley energy	68 01 00 00 00 00 00 68 11 04 3A 37 34 33 BE 16	4	XXXXXX. XX	kWh
Last July Positive active energy data block	68 01 00 00 00 00 00 68 11 04 3A 32 34 33 B9 16	4*5	XXXXXX. XX	kWh
Last August, the positive energy rate total energy	68 01 00 00 00 00 00 68 11 04 3B 33 34 33 BB 16	4	XXXXXX. XX	kWh
Last August, positive active rate, sharp energy	68 01 00 00 00 00 00 68 11 04 3B 34 34 33 BC 16	4	XXXXXX. XX	kWh
Last August, positive active rate peak energy	68 01 00 00 00 00 00 68 11 04 3B 35 34 33 BD 16	4	XXXXXX. XX	kWh
Last August, positive active rate, flat energy	68 01 00 00 00 00 00 68 11 04 3B 36 34 33 BE 16	4	XXXXXX. XX	kWh
Last August, positive active rate, valley energy	68 01 00 00 00 00 00 68 11 04 3B 37 34 33 BF 16	4	XXXXXX. XX	kWh
Last August Positive active energy data block	68 01 00 00 00 00 00 68 11 04 3B 32 34 33 BA 16	4*5	XXXXXX. XX	kWh
Last September, the positive energy rate total energy	68 01 00 00 00 00 00 68 11 04 3C 33 34 33 BC 16	4	XXXXXX. XX	kWh
Last September, positive active rate, sharp energy	68 01 00 00 00 00 00 68 11 04 3C 34 34 33 BD 16	4	XXXXXX. XX	kWh
Last September, positive active rate peak energy	68 01 00 00 00 00 00 68 11 04 3C 35 34 33 BE 16	4	XXXXXX. XX	kWh
Last September, positive active rate, flat energy	68 01 00 00 00 00 00 68 11 04 3C 36 34 33 BF 16	4	XXXXXX. XX	kWh
Last September, positive active rate, valley energy	68 01 00 00 00 00 00 68 11 04 3C 37 34 33 C0 16	4	XXXXXX. XX	kWh
Last September Positive active energy data block	68 01 00 00 00 00 00 68 11 04 3C 32 34 33 BB 16	4*5	XXXXXX. XX	kWh
Last October, the positive energy rate total energy	68 01 00 00 00 00 00 68 11 04 3D 33 34 33 BD 16	4	XXXXXX. XX	kWh
Last October, positive active rate, sharp energy	68 01 00 00 00 00 00 68 11 04 3D 34 34 33 BE 16	4	XXXXXX. XX	kWh
Last October, positive active rate peak energy	68 01 00 00 00 00 00 68 11 04 3D 35 34 33 BF 16	4	XXXXXX. XX	kWh
Last October, positive active rate, flat energy	68 01 00 00 00 00 00 68 11 04 3D 36 34 33 C0 16	4	XXXXXX. XX	kWh
Last October, positive active rate, valley energy	68 01 00 00 00 00 00 68 11 04 3D 37 34 33 C1 16	4	XXXXXX. XX	kWh
Last October, Positive active energy data block	68 01 00 00 00 00 00 68 11 04 3D 32 34 33 BC 16	4*5	XXXXXX. XX	kWh
Last November, the positive energy rate total energy	68 01 00 00 00 00 00 68 11 04 3E 33 34 33 BE 16	4	XXXXXX. XX	kWh
Last November, positive active rate,	68 01 00 00 00 00 00 68 11 04 3E 34 34 33 BF 16	4	XXXXXX.	kWh

sharp energy			XX	
Last November, positive active rate peak energy	68 01 00 00 00 00 00 68 11 04 3E 35 34 33 C0 16	4	XXXXXX. XX	kWh
Last November, positive active rate flat energy	68 01 00 00 00 00 00 68 11 04 3E 36 34 33 C1 16	4	XXXXXX. XX	kWh
Last November, positive active rate valley energy	68 01 00 00 00 00 00 68 11 04 3E 37 34 33 C2 16	4	XXXXXX. XX	kWh
Last November, Positive active energy data block	68 01 00 00 00 00 00 68 11 04 3E 37 34 33 BD 16	4*5	XXXXXX. XX	kWh
Last December, the positive energy rate total energy	68 01 00 00 00 00 00 68 11 04 3F 33 34 33 BF 16	4	XXXXXX. XX	kWh
Last December, positive active rate sharp energy	68 01 00 00 00 00 00 68 11 04 3F 34 34 33 C0 16	4	XXXXXX. XX	kWh
Last December, positive active rate peak energy	68 01 00 00 00 00 00 68 11 04 3F 35 34 33 C1 16	4	XXXXXX. XX	kWh
Last December, positive active rate flat energy	68 01 00 00 00 00 00 68 11 04 3F 36 34 33 C2 16	4	XXXXXX. XX	kWh
Last December, positive active rate valley energy	68 01 00 00 00 00 00 68 11 04 3F 37 34 33 C3 16	4	XXXXXX. XX	kWh
Last December, Positive active energy data block	68 01 00 00 00 00 00 68 11 04 3F 32 34 33 BE 16	4*5	XXXXXX. XX	kWh
Data	68 01 00 00 00 00 00 68 11 04 34 34 33 37 B8 16	4	YYMMD DWW	Year, month and day
Time	68 01 00 00 00 00 00 68 11 04 35 34 33 37 B9 16	3	HHFFMM	Hour, minute, second
Positive active maximum demand and time of occurrence	68 01 00 00 00 00 00 68 11 04 33 33 34 34 B4 16	8	XX.XXXX YYMMD Dhhmm	kW Year, month, day Hour, minute
Reverse active maximum demand and time of occurrence	68 01 00 00 00 00 00 68 11 04 33 33 35 34 B5 16	8	XX.XXXX YYMMD Dhhmm	Ditto
Perceptual reactive maximum demand and time of occurrence	68 01 00 00 00 00 00 68 11 04 33 33 36 34 B6 16	8	XX.XXXX YYMMD Dhhmm	
Capacitive reactive maximum demand and time of occurrence	68 01 00 00 00 00 00 68 11 04 33 33 37 34 B7 16	8	XX.XXXX YYMMD Dhhmm	
Forward apparent maximum demand and time of occurrence	68 01 00 00 00 00 00 68 11 04 33 33 3C 34 BC 16	8	XX.XXXX YYMMD Dhhmm	
Reverse apparent maximum demand and time of occurrence	68 01 00 00 00 00 00 68 11 04 33 33 3D 34 BD 16	8	XX.XXXX YYMMD	

			Dhhmm	
The maximum active demand and time of occurrence in the first settlement date	68 01 00 00 00 00 00 68 11 04 34 33 34 34 B5 16	8	XX.XXXX YYMMD Dhhmm	
Reverse active maximum demand and time of occurrence on the first settlement date	68 01 00 00 00 00 00 68 11 04 34 33 35 34 B6 16	8	XX.XXXX YYMMD Dhhmm	
Maximum demand and time of inductive reactive power on the first settlement date	68 01 00 00 00 00 00 68 11 04 34 33 36 34 B7 16	8	XX.XXXX YYMMD Dhhmm	
Capacitive reactive maximum demand and time of occurrence on the first settlement date	68 01 00 00 00 00 00 68 11 04 34 33 37 34 B8 16	8	XX.XXXX YYMMD Dhhmm	
The maximum demand and time of occurrence in the positive view on the first settlement date	68 01 00 00 00 00 00 68 11 04 34 33 3C 34 BD 16	8	XX.XXXX YYMMD Dhhmm	
The maximum demand and time of occurrence in the reverse view on the first settlement date	68 01 00 00 00 00 00 68 11 04 34 33 3D 34 BE 16	8	XX.XXXX YYMMD Dhhmm	
The maximum active demand and time of occurrence in the last 2 settlement days	68 01 00 00 00 00 00 68 11 04 35 33 34 34 B6 16	8	XX.XXXX YYMMD Dhhmm	
...	68 01 00 00 00 00 00 68 11 04 35 33 ... 34 ... 16	8	XX.XXXX YYMMD Dhhmm	
...	...			
The maximum active demand and time of occurrence on the 12th settlement date	68 01 00 00 00 00 00 68 11 04 3F 33 34 34 C0 16	8	XX.XXXX YYMMD Dhhmm	kW Year, month, day Hour, minute
...	68 01 00 00 00 00 00 68 11 04 3F 33 ... 34 ... 16	8	XX.XXXX YYMMD Dhhmm	Ditto
Phase A voltage 1st harmonic content	68 01 00 00 00 00 00 68 11 04 34 34 3D 35 C0 16	2	XX.XX	%
Phase A voltage 2nd harmonic content	68 01 00 00 00 00 00 68 11 04 35 34 3D 35 C1 16	2	XX.XX	%
Phase A voltage 3rd harmonic content	68 01 00 00 00 00 00 68 11 04 36 34 3D 35 C0 16	2	XX.XX	%
Phase A voltage 4th harmonic content	... 37 ... CS 16	2	XX.XX	%
...
Phase A voltage 21 harmonic content	68 01 00 00 00 00 00 68 11 04 48 34 3D 35 D4 16	2	XX.XX	%
Phase B voltage 1st harmonic content	68 01 00 00 00 00 00 68 11 04 34 35 3D 35 C1 16	2	XX.XX	%

B phase voltage 2nd harmonic content	68 01 00 00 00 00 00 68 11 04 35 35 3D 35 C2 16	2	XX.XX	%
B phase voltage 3rd harmonic content	68 01 00 00 00 00 00 68 11 04 36 35 3D 35 C2 16	2	XX.XX	%
B phase voltage 4th harmonic content	... 37 ... CS 16	2	XX.XX	%
...	...			
B phase voltage 4th harmonic content	68 01 00 00 00 00 00 68 11 04 48 35 3D 35 D5 16	2	XX.XX	%
Phase C voltage 1st harmonic content	68 01 00 00 00 00 00 68 11 04 34 36 3D 35 C2 16	2	XX.XX	%
phase c voltage 2nd harmonic content	68 01 00 00 00 00 00 68 11 04 35 36 3D 35 C3 16	2	XX.XX	%
Phase C voltage 3rd harmonic content	68 01 00 00 00 00 00 68 11 04 36 36 3D 35 C4 16	2	XX.XX	%
Phase c voltage 4th harmonic content	... 37 ... CS 16	2	XX.XX	%
...	...			
Phase C voltage 21 harmonic content	68 01 00 00 00 00 00 68 11 04 48 36 3D 35 D6 16	2	XX.XX	%
Phase A current 1st harmonic content	68 01 00 00 00 00 00 68 11 04 34 34 3E 35 C1 16	2	XX.XX	%
phase A current 2nd harmonic content	68 01 00 00 00 00 00 68 11 04 35 34 3E 35 C2 16	2	XX.XX	%
Phase A current 3rd harmonic content	68 01 00 00 00 00 00 68 11 04 36 34 3E 35 C3 16	2	XX.XX	%
Phase A current 4th harmonic content	... 37 ... CS 16	2	XX.XX	%
...	...			
Phase A current 21 harmonic content	68 01 00 00 00 00 00 68 11 04 48 34 3E 35 D5 16	2	XX.XX	%
Phase B current 1st harmonic content	68 01 00 00 00 00 00 68 11 04 34 35 3E 35 C2 16	2	XX.XX	%
B phase current 2nd harmonic content	68 01 00 00 00 00 00 68 11 04 35 35 3E 35 C3 16	2	XX.XX	%
Phase B current 3rd harmonic content	68 01 00 00 00 00 00 68 11 04 36 35 3E 35 C4 16	2	XX.XX	%
B phase current 4th harmonic content	... 37 ... CS 16	2	XX.XX	%
...	...			
Phase B current 21 harmonic content	68 01 00 00 00 00 00 68 11 04 48 35 3E 35 D6 16	2	XX.XX	%
Phase C current 1 harmonic content	68 01 00 00 00 00 00 68 11 04 34 36 3E 35 C3 16	2	XX.XX	%
Phase C current 2nd harmonic content	68 01 00 00 00 00 00 68 11 04 35 36 3E 35 C4 16	2	XX.XX	%
Phase C current 3rd harmonic content	68 01 00 00 00 00 00 68 11 04 36 36 3E 35 C5 16	2	XX.XX	%

content				
Phase C current 4th harmonic content	... 37 ... CS 16	2	XX.XX	%
...	...			
Phase C current 21 harmonic content	68 01 00 00 00 00 00 68 11 04 48 36 3E 35 D7 16	2	XX.XX	%
Phase A voltage waveform distortion	68 01 00 00 00 00 00 68 11 04 33 34 3B 35 BD 16	2	XX.XX	%
B phase voltage waveform distortion	68 01 00 00 00 00 00 68 11 04 33 35 3B 35 BE 16	2	XX.XX	%
Phase C voltage waveform distortion	68 01 00 00 00 00 00 68 11 04 33 36 3B 35 BF 16	2	XX.XX	%
Phase A current waveform distortion	68 01 00 00 00 00 00 68 11 04 33 34 3C 35 BE 16	2	XX.XX	%
Phase B current waveform distortion	68 01 00 00 00 00 00 68 11 04 33 35 3C 35 BF 16	2	XX.XX	%
Phase C current waveform distortion	68 01 00 00 00 00 00 68 11 04 33 36 3C 35 C0 16	2	XX.XX	%
(previous time) timed freezing time	68 01 00 00 00 00 00 68 11 04 34 33 33 38 B8 16	5	YYMMD Dhhmm	Year, month and day
(1 time) timed to freeze positive active energy	68 01 00 00 00 00 00 68 11 04 34 34 33 38 B9 16	4*5	XXXXXX. XX	kWh
(1 time) timed frozen reverse active energy	68 01 00 00 00 00 00 68 11 04 34 35 33 38 BA 16	4*5	XXXXXX. XX	kWh
(1 time) Timing freeze positive active demand and time of occurrence	68 01 00 00 00 00 00 68 11 04 34 3C 33 38 C1 16	8	XX.XXXX YYMMD Dhhmm	kW Year, month and day
(1 time) Timing freeze reverse active demand and time	68 01 00 00 00 00 00 68 11 04 34 3D 33 38 C2 16	8	XX.XXXX YYMMD Dhhmm	kW Year, month and day
(Last 1) timed frozen variable data	68 01 00 00 00 00 00 68 11 04 34 43 33 38 C8 16	3*8	kW kW kW kW kvar kvar kvar kvar	Total active power Phase A active power Phase B active power Phase C active power Total reactive power

				Phase A reactive power Phase B reactive power Phase C reactive power
(Previous 2) timing freezing time	68 01 00 00 00 00 00 68 11 04 35 33 33 38 B9 16	5	YYMMD Dhhmm	Year, month and day
...	68 01 00 00 00 00 00 68 11 04 35 ... 33 38 ... 16			
(previous 3 times) timing freezing time	68 01 00 00 00 00 00 68 11 04 36 33 33 38 BA 16	5	YYMMD Dhhmm	Year, month and day
...	68 01 00 00 00 00 00 68 11 04 36 ... 33 38 ... 16			
...	...			
(previous 12 times) timing freezing time	68 01 00 00 00 00 00 68 11 04 3F 33 33 38 C3 16	5	YYMMD Dhhmm	Year, month and day
...	68 01 00 00 00 00 00 68 11 04 36 ... 33 38 ... 16			
(previous time) instantaneous freezing time	68 01 00 00 00 00 00 68 11 04 34 33 34 38 B9 16	5	YYMMD Dhhmm	Year, month and day
(last time) freeze forward active energy instantaneously	68 01 00 00 00 00 00 68 11 04 34 34 34 38 BA 16	4*5	XXXXXX. XX	kWh
(last time) freeze reverse active energy instantaneously	68 01 00 00 00 00 00 68 11 04 34 35 34 38 BB 16	4*5	XXXXXX. XX	kWh
(1 time) instantaneous freezing positive active demand and time of occurrence	68 01 00 00 00 00 00 68 11 04 34 3C 34 38 C2 16	8	XX.XXXX YYMMD Dhhmm	kW Year, month day, hour, minute
(1 time) instantaneous freezing reverse active demand and time of occurrence	68 01 00 00 00 00 00 68 11 04 34 3D 34 38 C3 16	8	XX.XXXX YYMMD Dhhmm	kW Year, month day, hour, minute
(1 time) instantaneous freeze variable data	68 01 00 00 00 00 00 68 11 04 34 43 34 38 C9 16	3*8	kW kW kW kvar kvar kvar	Total active power Phase A active power Phase B active power

				Phase C active power Total reactive power Phase A reactive power Phase B reactive power Phase C reactive power
(2 times) instantaneous freeze time	68 01 00 00 00 00 00 68 11 04 35 33 34 38 BA 16	5	YYMMD Dhhmm	Year, month and day
...	68 01 00 00 00 00 00 68 11 04 35 ... 34 38 ... 16			
(Last 3 times) instantaneous freezing time	68 01 00 00 00 00 00 68 11 04 36 33 34 38 BB 16	5	YYMMD Dhhmm	Year, month and day
...	68 01 00 00 00 00 00 68 11 04 36 ... 34 38 ... 16			
...	...			
(Last 12 times) instantaneous freezing time	68 01 00 00 00 00 00 68 11 04 3F 33 34 38 C4 16	5	YYMMD Dhhmm	Year, month and day
...	68 01 00 00 00 00 00 68 11 04 3F ... 34 38 ... 16			

12 Profibus-DP guide

12.1 Profibus-DP Protocol overview

This chapter briefly introduces the Profibus-DP protocol. If you are familiar with this section, you can directly read the communication configuration of Section 12.2.

12.1.1 Profibus-DP Introduction

Profuse is a fieldbus solution integrating H1 (process) and H2 (factory automation). It is an international, open fieldbus standard and one of the eight fieldbuses in the international standard IEC61158. Profibus can spread digital automation equipment from low-level (sensor/actuator) to intermediate-level execution level (cell level). According to the application characteristics and different needs of users, Profibus provides three compatible version communication protocols: FMS 、 PA and DP .

Profibus-DP Used for communication between unit level control devices and distributed I/O in automation systems.

Profibus-DP Using Layer 1, Layer 2 and User Interface layers, Layers 3-7 are unused, and this streamlined architecture ensures high-speed data transfer. The direct data link mapping program DDLM provides access to Layer 2. The user interface specifies the application functions of the device, the behavior of the Profibus-DP system and the

device. Profibus-DP is especially suitable for communication between PLCs and on-site hierarchical I/O devices. The communication between the master stations is the token mode, the master-slave mode between the master station and the slave station, and a mixture of the two methods.

12.1.2 Profibus-DP physical layer

12.1.2.1 Transmission medium.

PROFIBUS-DP transmission technology adopts RS485 transmission, and the transmission medium can select two types of wires: type A and type B, A is a shielded twisted pair, and B is a common twisted pair. However, in the EN50 170 standard, the type A wire is specified, and the type A has a larger extended length than the type B, as shown in Table 6.

Table6: Line A Line B Description

Cable parameter	A type	B type
Characteristic impedance(Ω)	135~165 Ω (f= 3MHz~20MHz)	100~130 Ω (f> 100kHz)
Unit length capacitance(PF/m)	< 30pF/m	< 60pF/m
Loop resistance(Ω /km)	\leq 110 Ω /km	-
Core cross-sectional area(mm ²)	\geq 0.34mm ² (22 AWG)	\geq 0.22mm ² (22 AWG)

12.1.2.2 Transmission distance

The standard Profibus-DP supports the following transmission rates: (unit: kbps) 9.6, 19.2, 31.25, 45.45, 93.75, 187.5, 500, 1500, 3000, 6000, 12000. The input data and output data of each DP slave are up to 244B. When using shielded twisted pair cable, the longest communication distance is 9.6km (requires additional relay), and the maximum length is 90km when using fiber optic cable.

The maximum cable length of each segment of Profibus-DP is related to the transmission rate. Different media, different baud rates, and different distances that signals can be transmitted are shown in Table 7.

Table 7: Transmission rate and distance relationship table

Baud rate kbps/s	9.6	19.2	93.75	187.5	500	1500	3000	6000	12000
(Line A) cable length m	1200	1200	1200	1000	400	200	200	100	100
(Line B) cable length m	1200	1200	1200	600	200	Not recommended	Not recommended	Not recommended	Not recommended

Note: This transmission distance refers to the distance without repeaters (repeaters). In addition, the transmission distance is a theoretical value, and the actual transmission distance is also affected by the on-site environment.

12.1.2.3 PROFIBUS-DP Bus network structure

PROFIBUS supports bus, star and tree topologies. A bus topology, as shown in Figure 1. The standard Profibus-DP system can connect up to 127 stations (station numbers from 0 to 126, without repeaters). PROFIBUS supports repeater connections. If a repeater is used, the cable length and the number of connected stations can be increased.PROFIBUS



图 1 DP Bus topology

According to the EIA RS485 standard, in order to minimize cable reflection and ensure the noise level defined on the data line, at each end of the data transmission cable, a terminating resistor connected as follows must be used to terminate a network segment. The bus terminator is shown in Figure 2.

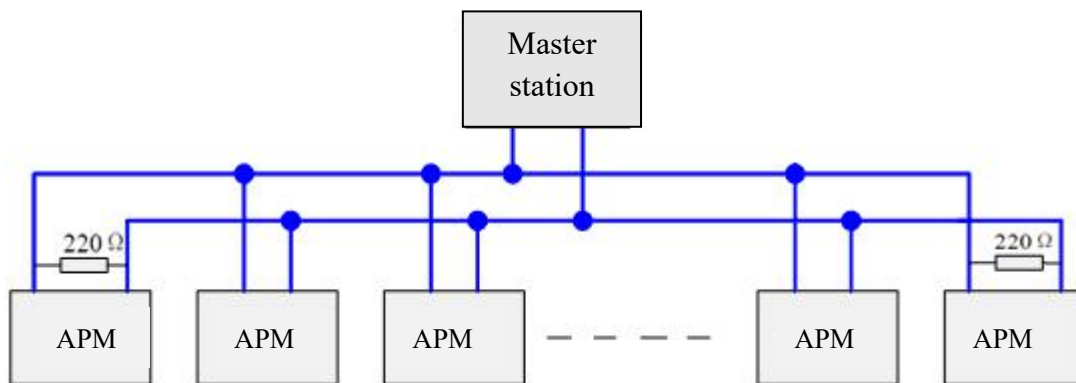
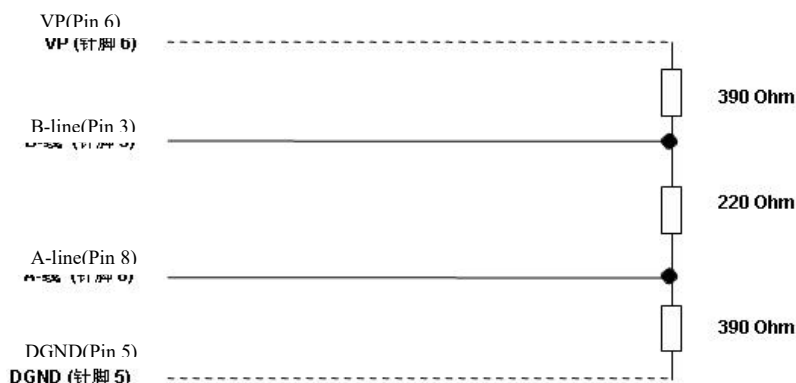

Figure 2 PROFIBUS Cable terminator for cable (pin number of 9-pin D-type connector)

Profibus's bus terminator consists of a pull-up resistor and a pull-down resistor. When there is no station transmitting data on the bus (ie idle time), these two resistors force different state voltages to a certain value, thus ensuring that there is on the bus. A certain idle potential. The station designated as the terminating bus (common with the bus terminator) needs to be added to the "terminator", also known as the active terminal. To achieve impedance matching and enhance anti-interference ability. For the A-type cable, connect 220Ω active termination resistor.

The above information is for reference only. Due to the high content of Profibus-DP, please refer to the PROFIBUS installation related specifications for details.

12.2 Profibus Communication function configuration

12.2.1 Profibus Communication variable table

When communicating with the Profibus protocol, the APM series programmable smart meter needs to use the communication variables of this document. Chapter 8 Communication Description Section is invalid.

APM series multi-function electrical measuring instrument, its communication protocol is developed according to DPV0. DPV0 is a periodic data exchange, that is, in each DP cycle, the exchanged data is periodic data.

The input data is: the response data fed back to the DP master by the multi-function electrical measuring instrument (APM series meter → DP master station).

The output data is: the DP master sends to the multi-function electrical measuring instrument (DP master → APM series instrument), the instrument without switching output function (ie no DO function), no output data.

The processing of the cyclic data is done in the PLC by programming the input data and the output data. The length of the input and output exchange data depends on the hardware configuration GSD file type.

(1) Profibus input data address table, as shown in Table 3. Its high byte is first and the low byte is after. For example, [2][3], [2] is the high byte (high 8 bits), [3] is the low byte (lower 8 bits), and so on.

(2) If you want to set the APM series instrumentation parameters, you need to refer to Chapter 7 for manual

setting, or refer to Chapter 8 for setting by modbus-rtu protocol. You can not use Profibus remote operation setting.

(3) After the instrument is powered on, if the instrument slave address is changed (address setting value range 1~126), the instrument needs to be powered on again, and the changed slave address can be valid (this function follows the PROFIBUS-DP protocol).

(4) After Profibus communication, the baud rate is adaptive from 9.6 kbit/s to 12000 kbit/s, and no baud rate is required.

APM_Profibus Communication variable table

Input data Address table	parameter name	remark	type	word
[00][01] [02][03]	Output switch state DO	[00]: High 8 bits, reserved [01]: Low 8 bits Bit7-Bit2:reserved Bit0: D01 Output switch quantity 1 Bit1: D02 Output switch quantity 2 So on... Bit31: DO32 Output switch quantity 32	2 word	1、 2
[04][05] [06][07]	Input switch state DI	Bit0: DI1 Output switch quantity 1 Bit1: DI2 Output switch quantity 2 Bit2: DI3 Output switch quantity 3 Bit3: DI4 Output switch quantity 4 So on... Bit31: DI32 DO32 Output switch quantity 32	2word	3、 4
[8][9]	Phase voltage Uan	Secondary side	Voltage decimal point: 1 16-bit unsigned	1 word 5
[10][11]	Phase voltage Ubn	Secondary side		1 word 6
[12][13]	Phase voltage Ucn	Secondary side		1 word 7
[14][15]	Phase voltage Uab	Secondary side		1 word 8
[16][17]	Line voltage Ubc	Secondary side		1 word 9
[18][19]	Line voltage Uca	Secondary side		1 word 10
[20][21]	Phase current Ia	Secondary side	Current decimal point	1 11

			number: 3	word	
[22][23]	Phase current Ib	Secondary side	16-bit unsigned	1 word	12
[24][25]	Phase current Ic	Secondary side		1 word	13
[26][27]	Neutral current	Secondary side		1 word	14
[28][29] [30][31]	Total active power P total	Secondary side	Active power, Reactive power, inspecting power Decimal points: 2 32-bit signed	2 word	15、16
[32][33] [34][35]	Total reactive power Q total	Secondary side		2 word	17、18
[36][37] [38][39]	Total apparent power S	Secondary side		2 word	19、20
[40][41]	Power factor	Secondary side	Decimal points: 3 16-bit signed	1 word	21
[42][43]	frequency	Secondary side	Decimal points: 2 16-bit unsigned	2 word	22
[44][45]	Phase A current total harmonic distortion rate	A phase current total harmonic content; Decimal points: 2 (16-bit unsigned)		1 word	23
[46][47]	Phase B current total harmonic distortion rate	The total harmonic content of phase B current; Decimal points: 2 (16-bit unsigned)		1 word	24
[48][49]	Phase C current total harmonic distortion rat	C phase current total harmonic content; Decimal points: 2 (16-bit unsigned)		1 word	25
[50][51]	Phase A voltage total harmonic distortion rate	A phase voltage total harmonic content; Decimal points: 2 (16-bit unsigned)		1 word	26
[52][53]	Phase B voltage total harmonic distortion rate	B phase voltage total harmonic content; Decimal points: 2 (16-bit unsigned)		1 word	27
[54][55]	Phase C voltage total harmonic distortion rate	C phase voltage total harmonic content; Decimal points: 2 (16-bit unsigned)		1 word	28
[56][57] [58][59]	Positive active energy	Secondary side EPI	Secondary side electrical energy Decimal points: 3 32-bit signed	2 word	29、30
[60][61] [62][63]	Reverse active energy	Secondary side EPE		2 word	31、32
[64][65] [66][67]	Positive reactive energy	Secondary side EQL		2 word	33、34
[68][69] [70][71]	Reverse reactive energy	Secondary side EQC		2 word	35、36
[72][73] [74][75]	Positive total active energy	Secondary side electrical energy Decimal points: 3		2 word	37、38
[76][77]	Positive tip active energy	32-bit signed		2	39、40

[78][79]			word	
[80][81] [82][83]	Positive peak active energy		2 word	41、42
[84][85] [86][87]	Positive flat active energy		2 word	43、44
[88][89] [90][91]	Positive valley active energy		2 word	45、46
[92][93]	AI1	Analog input Decimal points: 3 16-bit unsigned	1 word	47
[94][95]	AI2		1 word	48
[96][97]	AI3		1 word	49
[98][99]	AI4		1 word	50
[100][101]	AI5		1 word	51
[102][103]	Secondary current value	Secondary current (1A or 5A) Decimal points: 0 16-bit unsigned	1 word	52
[104][105]	Secondary side voltage value	Secondary side voltage (100V, 110V, 400V, 690V) Decimal points: 0 16-bit unsigned	1 word	53
[106][107]	Primary current value	Primary current (1-32760A) Decimal points: 0 16-bit unsigned	1 word	54
[108][109]	Primary side voltage value	Primary side voltage (100V-1200KV) Decimal points: 0 32-bit unsigned	2 word	55、56
[110][111]	Secondary side neutral current value	Secondary current (1A or 5A) Decimal points: 0 16-bit unsigned	1 word	57
[112][113]	Primary side neutral current value	Primary current (1-32760A) Decimal points: 0 16-bit unsigned	1 word	58

(5)Output parameter 1 word (DP master → APM series meter), configuration table is as follows:

output	parameter name	Numerical range	Remarks
[00][01]	Control(word)	01]Low 8 digits Bit0: DO1 Bit1: DO2 Bit2-Bit7: Reserved	0: disconnect 1: closure

	[00]High 8 Bit15: permission modification enabled Bit14-Bit8: Reserved	When this bit is 1, it is valid for the operation of bit0 and bit1. When 0, the operation is invalid.
--	---	---

Note: PROFBUS-DP V0 is a cyclic data exchange. It should be used with caution for control information to avoid damage caused by repeated settings and loop settings

Example: If you want to operate on the DO switch, you need to operate according to the current DO state. Assume that the current state of D0 is: DO1 is closed, D02 is off. If you want to close DO2, the output control word is: 8003 (hexadecimal). If the output control word is 8002, closing DO3 will also turn DO1 off.

12.2.2 Conversion relationship between communication value and actual value

12.2.2.1 Correspondence between communication value and actual value (available Val_t is the communication readout value and Val_s is the actual value)

The correspondence between the communication value and the actual secondary side measurement value is as follows:

Applicable parameters	Correspondence	Unit
Voltage U _{an} 、U _{bn} 、U _{cn} 、U _{ab} 、U _{bc} 、U _{ca}	Val _s =Val _t /10	V
Current I _A 、I _B 、I _C	Val _s =Val _t /1000	A
Power factor P _{FA} 、P _{FB} 、P _{FC} 、P _{FS}	Val _s =Val _t /100	No unit
Frequency FR	Val _s =Val _t /100	Hz
Voltage total harmonic distortion rate THDU _a 、THDU _b 、THDU _c Current total harmonic distortion rate THDI _a 、THDI _b 、THDI _c	Val _s =Val _t /100	%

12.2.2.2 Voltage, current, power factor, frequency

Each electrical parameter occupies 1 WORD, taking the A-phase voltage U_{an} as an example. The communication readout value Val_t is 2200, then the actual value is: Val_s = Val_t / 10 = 2200 / 10 = 220 V。

12.2.2.3 Power, reactive power, apparent power(Secondary; W/Var/VA)

Each electrical parameter occupies 2 WORDs, and the correspondence between the communication value and the actual value is: Val_s=Val_t / 100; where Val_t=the first word × 65536+the second word. Taking the A-phase active power P_a as an example, the communication value is read from the address [24][25], and the communication value is 26000 from the address [26][27], that is, Val_t=1 × 65536+26000=91536, the corresponding actual value is: Val_s = Val_t / 100 = 915.36W.

12.2.2.4 Voltage and current harmonic data (voltage total harmonic distortion rate, current total harmonic distortion rate)

Each electrical parameter occupies 1 WORD, and the correspondence between the communication value and the actual value is:

Val_s=(Val_t/100)%. Taking the total harmonic distortion rate of phase A voltage as an example, the readout communication value Val_t is 157, then the actual value is Val_s=(Val_t / 100)%=1.57%, that is, the total harmonic distortion rate of phase A voltage is 1.57%.

12.2.2.5 Energy data (primary side)

The value of the primary side of the energy is the floating point variable data type. It uses the sign bit to represent the sign of the number, and the step code and the mantissa to represent the size of the number. The data format adopted by the instrument is IEEE754 data format with 24-bit precision. The high bit of the mantissa is always "1", so it is not saved. The bit distribution is as follows:

1-bit sign bit, 8-bit exponent bit, 23-bit mantissa, sign bit is the highest bit, and the mantissa is the lowest 23

bits.

Specific examples are as follows:

Read number: 0 10001110 100 1011 1010 1100 0000 0000b

Sign bit S=0, (“1” negative, “0” positive);

Calculation index E=10001110, Turn into a decimal number 142;

Calculate mantissa M=100 1011 1010 1100 0000 0000, Turn into a decimal number 4959232.

Calculation formula:

$$\text{Primary side electric energy} = (-1)^S \times 2^{(E-127)} \times \left(1 + \frac{M}{2^{23}}\right)$$

The calculation result in the above example is:

$$(-1)^0 \times 2^{(142-127)} \times \left(1 + \frac{4959232}{2^{23}}\right) = 52140 \text{ wh} = 52.14 \text{ kWh}$$

12.2.3 About the GSD file description

GSD File access:

The instrument's GSD file can be downloaded from the company's website at www.acrel.cn or from our customer service.

CD mode is sent with the product

When configuring the PROFIBUS master station, after loading the GSD file of the APM series instrument, the user parameters adopt the default values and do not need to be changed, as shown in the figure below.

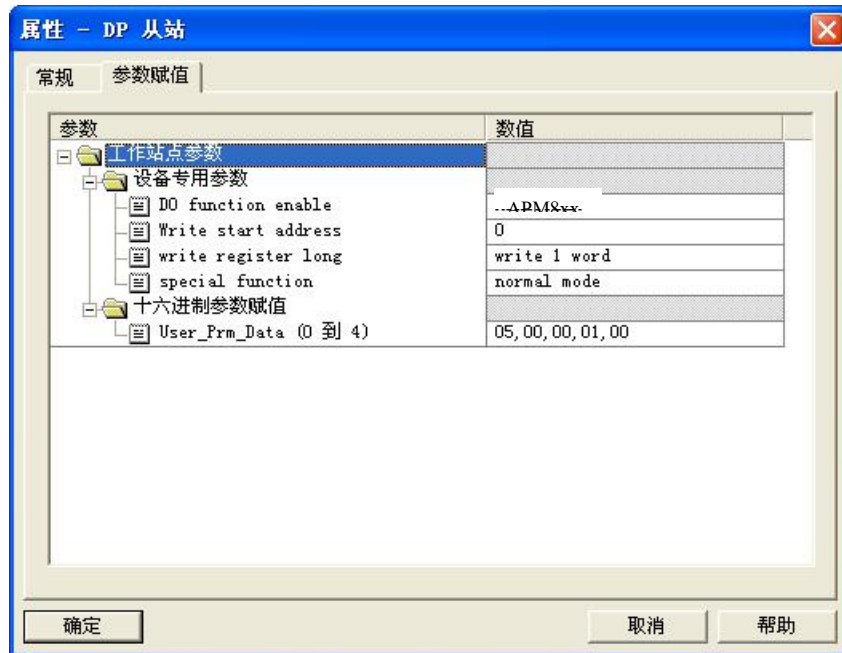

13. Profinet

PROFINET is a field bus communication system based on industrial Ethernet and IT standards, which has more advantages than PROFIBUS, so it is more and more widely used in the field of automation control.

13.1 connection preparation

13.1.1 Transmission media and connectors

PROFINET supports 100BASE-TX of 100M Ethernet, adopts two pairs of shielded twisted pair (GP2X2 series)

as short-distance signal transmission (compatible with conventional 8-core network cable), and uses RJ45 (commonly known as crystal head) connector as terminal.

As shown in Figure 1, it is the standard for making network cables:

T568A standard: white green, green, white orange, blue, white blue, orange, white brown and brown.

T568B standard: white orange, orange, white green, blue, white blue, green, white brown and brown.

Linear sequence of crystal head: from left to right, they are 1 2 3 4 5 6 7 8 respectively. Four-core network cable only needs to be connected to 1 2 3 6.

As shown in Figure 2, it is the direct connection and cross connection mode of 4-core network cable, and as shown in Figure 3, it is the direct connection and cross connection mode of 8-core network cable. All the connection modes in the figure can communicate normally.

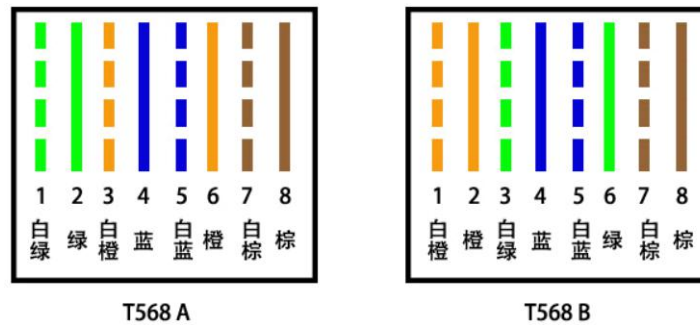

Figure 1

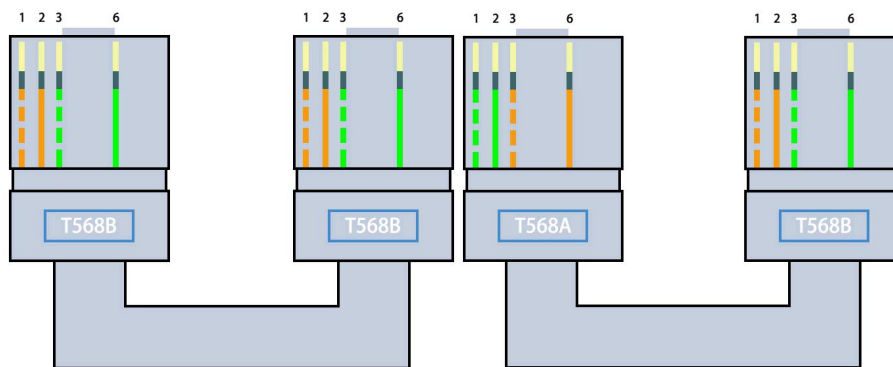

Figure ii

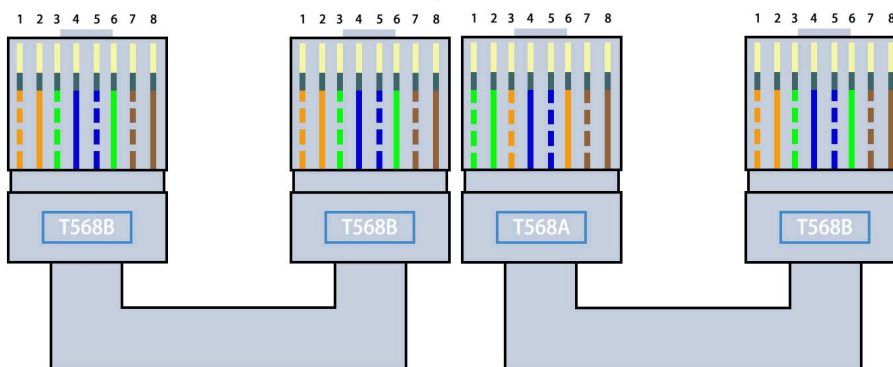

Figure 3

13.1.2 Topological structure

PROFINET network supports linear, star, tree, ring and mixed network topologies.

Linear topology: APM's PROFINET communication module has dual network ports with switch function, and linear connection can be realized by using the second network port in linear topology.

Star topology: When the equipment is close, such as the equipment is installed in the control cabinet, it is suitable to use star topology, and switches are used to connect APMs for short-distance areas.

Tree topology: connect several stars into a tree network, and finally form a hierarchical network of factory automation.

Ring topology: several switches are connected by optical fiber to form a backbone ring network. Field devices can be connected with switches by using a mixed topology, and the field network and the upper network are also connected through switches.

13.2 Configuration Configuration

Description: This manual takes Siemens CPU1515-2PN as the ProNet master station, and introduces the configuration method of ProNet communication with APM as the slave station. The PLC programming software used in this paper is TIA Portal V15.1

13.2.1 install the GSML file.

Click Options-Manage Generic Station Description File (GSD) to enter the management interface, as shown in Figures 4 and 5. In the interface shown in Figure 5, select the path of the file GSDML-V2.35-Acrel-APM-20220327.xml, select the file and click Install. After the installation is completed, close the current window and the software will automatically update the directory.



Figure 4

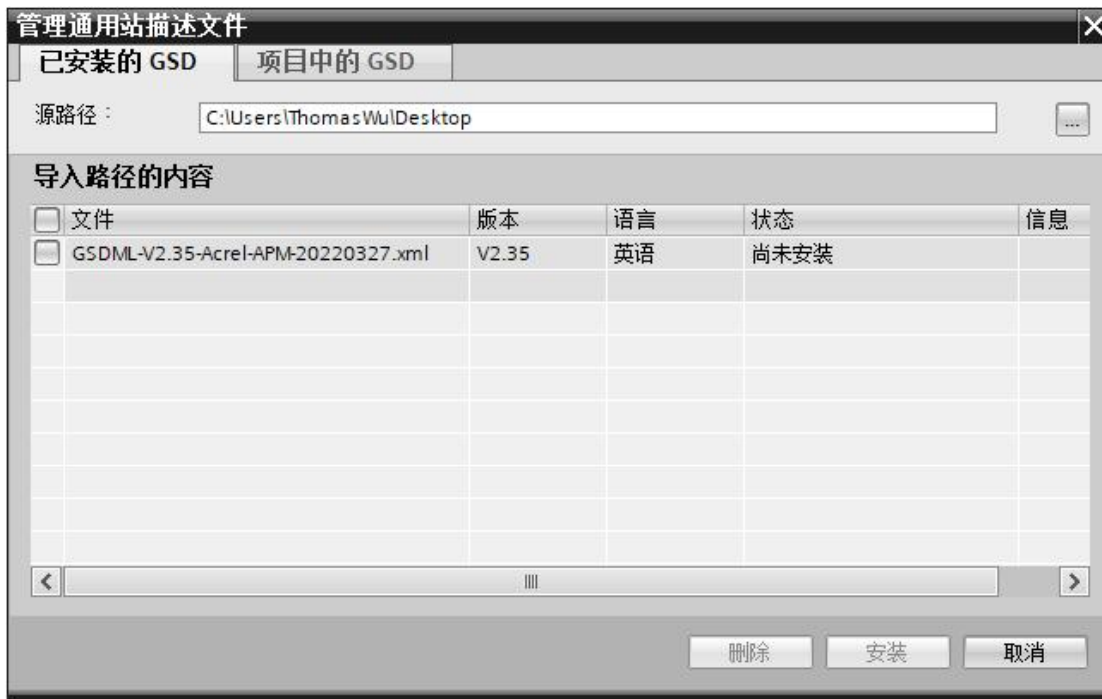

Figure 5

After the installation is completed, the equipment APM PN can be found in other field devices/profinet/io/acrel/acrelamp/in the hardware directory, as shown in Figure 6.

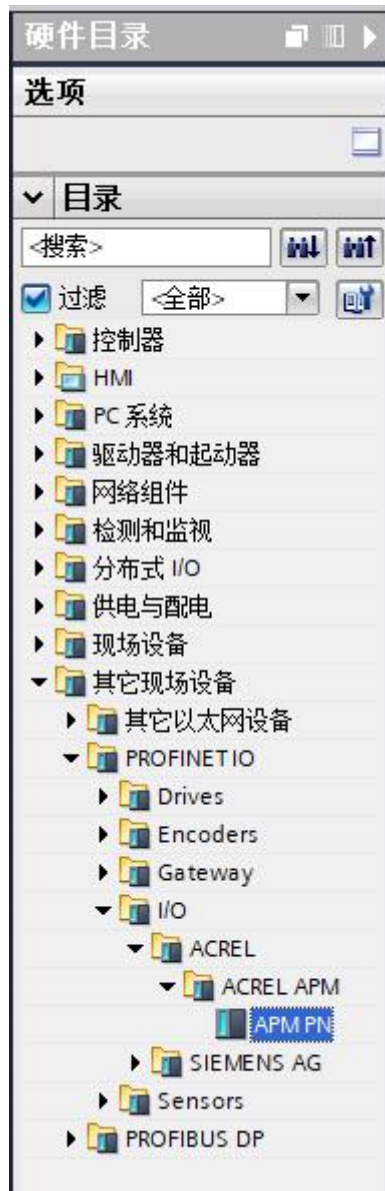

Figure 6

13.2.2 Configuration

(1) Create a new project. After selecting the CPU model, click the network view, and find the equipment APM PN in the hardware directory/Profinet/IO/Acrel/Acrelamp/. Double-click to add the equipment, as shown in Figure 7.



Figure 7

(2) Click the word "Unassigned" of the slave station equipment as shown in Figure 8, and select the PROFINET interface to be connected. After the connection is completed, as shown in Figure 9.



Figure VIII

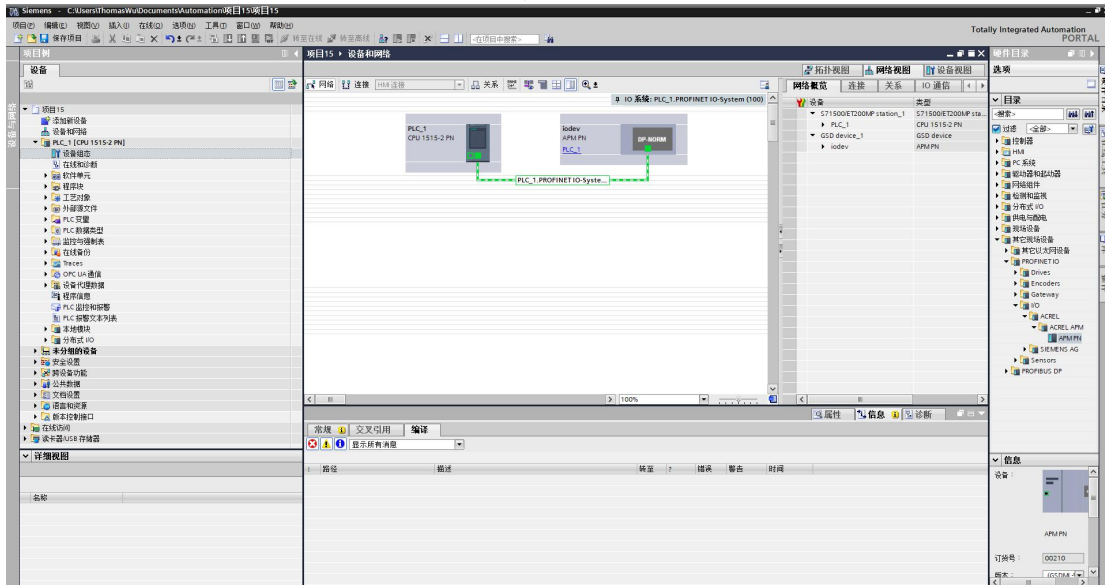

Figure 9

- (3) Double-click the CPU to set the network parameters of the main station, such as IP address, subnet mask, routing, etc.
- (4) Select the position shown in Figure 10 to modify the name of the configured slave device. Click the gray part to set the configured slave IP address.

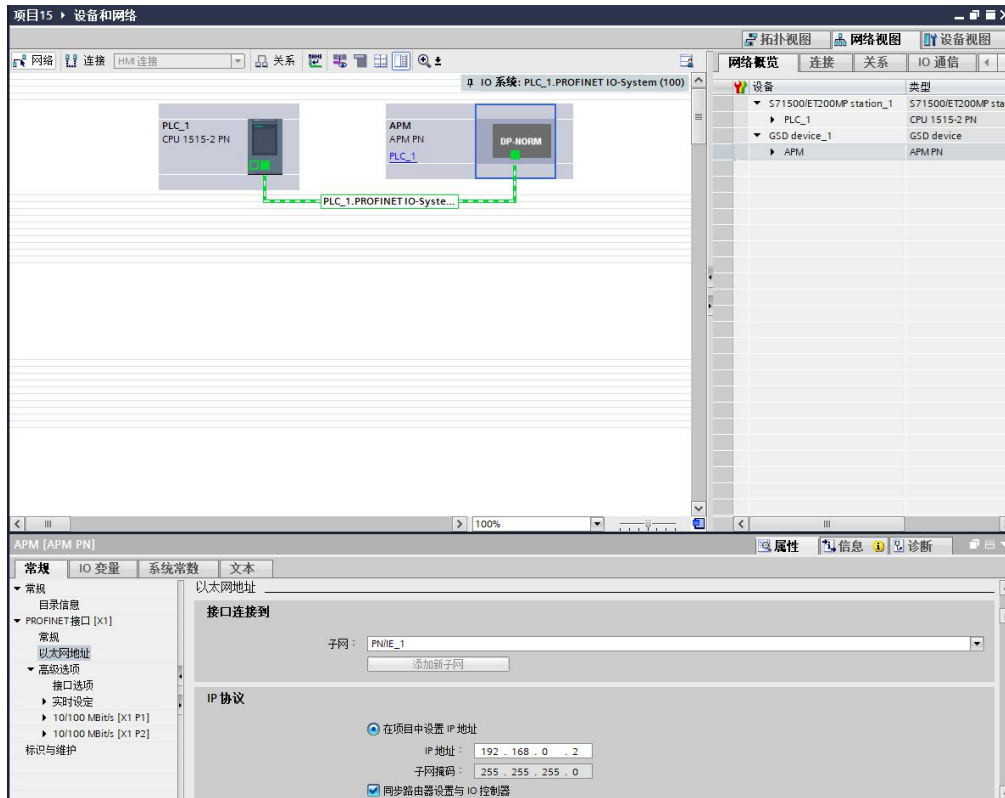

Figure X

13.2.3 Specify the name of the equipment.

As shown in Figure 12, click Online-Assign Device Name to enter the interface of assigning PROFINET device name. Click the update list button to search all connected PROFINET devices, select the device to be modified, and click Assign Name to complete name modification.

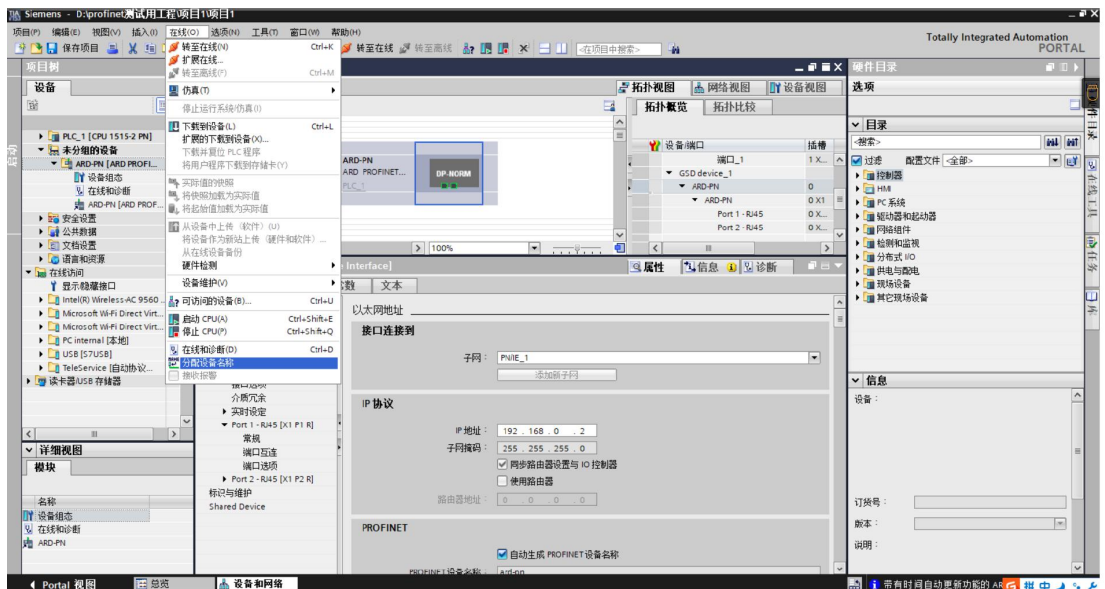

Figure Xi

13.3 mailing address list

The initial default input address table is as follows.

Default Input Data Address Table (APM→ Master Station)

Input	data	Parameter name	remarks	data type	The x word
-------	------	----------------	---------	-----------	------------

address table				
[0][1]	DO status	Bit0 corresponds to DO1.	word	one
[2][3]	DI state	Bit0 corresponds to DI1.	word	2
[4][5]	Phase voltage UA	secondary side Decimal point: 1 16 bit unsigned	word	three
[6][7]	Phase voltage UB		word	four
[8][9]	Phase voltage UC		word	five
[10][11]	Line voltage UAB		word	six
[12][13]	Line voltage UBC		word	seven
[14][15]	Line voltage UCA		word	eight
[16][17]	Phase current IA		secondary side Decimal point: 3 16 bit unsigned	word
[18][19]	Phase current IB	word		10
[20][21]	Phase current IC	word		11
[22][23]	Neutral IINe current in	word		12
[24][25]	Frequency f	Decimal point: 2 16 bit unsigned	word	13
[26][27] [28][29]	Total active power	secondary side Decimal point: 2 digits and 32 digits are signed.	2 word	14, 15
[30][31] [32][33]	Total reactive power	secondary side Decimal point: 2 digits 32-bit signed	2 word	16, 17
[34][35] [36][37]	Total apparent power	secondary side Decimal point: 2 digits 32-bit signed	2 word	18, 19
[38][39]	Total power factor	Decimal point: 3 digits 32-bit signed	word	20
[40][41] [42][43]	Forward active energy	secondary side Decimal point: 3 digits 32-bit signed	2 word	21, 22
[44][45]	Reverse active	secondary side	2 word	23, 24

[46][47]	energy	Decimal point: 3 digits 32-bit signed		
[48][49] [50][51]	Inductive reactive energy	secondary side Decimal point: 3 digits 32-bit signed	2 word	25, 26
[52][53] [54][55]	Capacitive reactive energy	secondary side Decimal point: 3 digits 32-bit signed	2 word	27, 28
[56][57]	Current secondary rating	1A or 5A	word	29
[58][59]	Voltage secondary rating	100V、110V、 400V、690V	word	30
[60][61]	Current primary rating	1-32760A	word	31
[62][63] [64][65]	Primary voltage rating	100V-1200KV	2word	32, 33

Note: the high byte comes first and the low byte comes last, such as [0][1], [0] is the high 8 bits, [1] is the low 8 bits, and so on. The electric energy is stored in hexadecimal with 4 bytes, with the high word in front and the low word in the back, and the measurement unit is: kWh; ; Energy metering value = energy high word *0xffff+ energy low word. One value needs to be multiplied by PTCT.

14. Analysis of common fault

Fault content	Analysis	Note
No display on power	Check whether the power supply voltage is in the working voltage range.	
Incorrect reading of voltage and current	Check the rated voltage and current of the primary side and secondary side is correct. Check whether the wiring mode setting is consistent with the actual wiring. Check voltage transformer, current transformer is in good condition.	
Incorrect power or power factor	Check whether the wiring mode setting is consistent with the actual wiring. Check the voltage and current phase sequence is correct.	
Communication is abnormal	Check whether the address, baud rate, parity, etc. in the communication settings are consistent with the host computer. Check the RS485 converter is normal. Parallel over 120 Ω resistance at the end of communication.	
Ethernet communication is abnormal	Check whether the IP address, subnet mask, gateway address, and port number settings are correct. Check whether the host computer and the meter network address is the same	

	network segment	
The extended module flashes red	<p>As with the TF card, check if the TF card is loose or damaged (view in communication or display).</p> <p>Check whether the meter time is accurate. If the meter system time is set incorrectly, the TF card will not be read.</p> <p>If there is still a malfunction and the fault is not eliminated after the meter is restarted, it is necessary to return to the factory for repair.</p>	
The thermometer reads 0 or -100	Check whether the module wiring is correct	

change the date	Model before change	Changed model	Change content
	V1.0	V1.1	1. Increase unbalance algorithm, nominal voltage and frequency; 2. Modify and increase Modbus communication address
	V1.1	V1.2	1. Detailed operation steps of reading data by SD card; 2. Add neutral current connection mode to the wiring diagram.
	V1.2	V1.3	1. Increase the icon display of LCD navigation interface.
	V1.3	V1.4	1. SD card is operated by card reader; 2. The system time is set incorrectly, resulting in the data on the SD card not being read (fault analysis); 3. Add the phase angle of voltage and current to the previous overview; 4. Add the address table of Ethernet module Modbus-TCP.
	V1.5	V1.6	1. Add the addresses of Profibus's electric energy and 5 analog input.
	V1.6	V1.7	1. Add the main interface settings; 2. Delete the mail setting function of Ethernet.
	V1.7	V1.8	1. Add note: The maximum flip angle is 90.
	V1.8	V1.9	1. Increase the content of temperature and humidity control; 2. Modify the company address
	V1.9	V2.0	1. Add the wiring diagram of MTP, MTN and MTH.
2021.11.4	V2.0	V2.1	1. Add the description of power supply voltage
2022.10.20	V2.1	V2.2	1. Profinet communication content has been added.
2023.5.31	V2.2	V2.3	1. The address table was added, and the check rate was revised.
2024.2.22	V2.3	V2.4	1. The four-rate address table was deleted.
2024.2.22	V2.3	V2.4	1. The four-rate address table was deleted.
2025.2.10	V2.4	V2.5	1. Modify MTH wiring diagram 2. Add a deviation address table 3. Modify the PN communication energy calculation formula 4. Revise the back cover

Headquarters: Acrel Co., Ltd.

Trade Company: Acrel E-Business(Shanghai)Co., Ltd.

Address: No.253 Yulv Road, Jiading District, Shanghai, China

TEL.: 0086-21-69156352

Web-site: www.acrel-electric.com

E-mail: sales@acrel-electric.com

Postcode: 201801

Manufacturer: Jiangsu Acrel Electrical Manufacturing Co., Ltd.

Address: No.5 Dongmeng Road, Dongmeng industrial Park, Nanzha Street, Jiangyin City, Jiangsu
Province, China

TEL./Fax: 0086-510-86179970

Web-site: www.jsacrel.com

E-mail: sales@email.acrel.cn

Postcode: 214405