

745



ARB4 弧光保护装置

ARB4 Arc Flash Protection Relay

安装使用说明书 v1.0

Operational Manual v1.0

安科瑞电气股份有限公司
Acrel CO.,LTD

申 明

DECLARATION

版权所有，未经本公司之书面许可，此手册中任何段落，章节内容均不得被摘抄、拷贝或以任何形式复制、传播，否则一切后果由违者自负。

本公司保留一切法律权利。

All rights reserved. No part of this publication may be reproduced, stored in a retrieval system, or transmitted in any form by any means, electronic, mechanical photocopying, recording, or otherwise without prior permission of our company. The violator will bear the dependent legal responsibility.

We reserve all the rights.

本公司保留对本手册所描述之产品规格进行修改的权利，恕不另行通知。

订货前，请垂询当地代理商以获悉本产品的最新规格。

We reserve all the rights to revise product specification without notice. Please consult local agent to get the latest information of our products specification.

目 录

CONTENTS

第一章 使用说明.....	1
Chapter 1 Brief introduction.....	1
1 装置介绍.....	1
1 Device Introduction.....	1
1.1 概述.....	1
1.1 Information.....	1
1.2 特点.....	2
1.2 Feature.....	2
1.3 装置选型表.....	4
1.3 Device Selection Table.....	4
1.4 装置功能对照表.....	5
1.4 Selection guide.....	5
2 ARB4 装置技术参数.....	7
2 ARB4 device technical parameters.....	7
2.1 额定参数.....	7
2.1 Rated parameters.....	7
2.2 主要技术性能.....	9
2.2 Basic mechanical design feature.....	9
2.3 正常工作环境条件.....	9
2.3 Normal working conditions.....	9
2.4 绝缘性能.....	10
2.4 Insulating property.....	10
2.5 电磁兼容性能.....	10
2.5 Electromagnetic compatibility performance.....	10
2.6 阻燃性能.....	11
2.6 Flame retardant performance.....	11
3 ARB-S 弧光传感器及光纤技术参数.....	11
3 ARB-S arc sensor and fiber optic technical parameters.....	11
3.1 ARB-S 弧光传感器技术参数.....	11
3.1 Technical parameters of ARB-S arc sensor.....	11
3.2 双股塑料光纤技术参数.....	12
3.2 Technical parameters of double core plastic optical fiber.....	12
4 开孔尺寸和安装位置.....	14
4 Hole size and installation position.....	14
4.1 装置开孔尺寸和安装位置.....	14
4.1 Device opening size and installation position.....	14

4.2 传感器开孔尺寸和安装位置.....	15
4.2 Sensor hole size and installation position.....	15
4.3 施工注意事项.....	21
4.3 Construction precautions.....	21
5 装置操作说明.....	22
5 Operational Manual.....	22
5.1 前面板说明.....	22
5.1 Surface.....	22
5.2 按键说明.....	23
5.2 Key instructions.....	23
5.3 菜单说明.....	24
5.3 Menu instructions.....	24
第二章 技术说明.....	37
Chapter 2 Technical Description.....	37
1 保护功能原理.....	37
1 Protection Principle.....	37
1.1 弧光保护.....	37
1.1 Arc protection.....	37
1.2 弧光监测及故障点定位功能.....	39
1.2 Arc monitoring and fault location function.....	39
1.3 弧光传感器及光纤链路监测.....	40
1.3 Arc sensor and fiber optic link monitoring.....	40
1.4 失灵保护.....	41
1.4 Failure protection.....	41
1.5 CT 断线监测.....	42
1.5 CT monitoring.....	42
1.6 非电量保护.....	42
1.6 Non-electric quantity protection.....	42
1.7 装置异常自检.....	43
1.7 Device Abnormal Self Test.....	43
1.8 检修状态闭锁.....	43
1.8 Maintenance status locking.....	43
2 参数表.....	44
2 Parameter Table.....	44
2.1 定值设置表.....	44
2.1 Fixed value setting table.....	44
2.2 软压板设置表.....	48
2.2 Soft pressing plate setting table.....	48
3 背板端子定义和二次原理图.....	49
3 Backboard terminal definition and secondary schematic diagram.....	49
3.1 背板端子定义图.....	49
3.1 Backboard terminal definition diagram.....	49
3.2 二次原理图.....	50
3.2 schematic diagram.....	50

第三章 典型配置及应用	53
Chapter 3 Typical Configuration and Application	53
1 电缆室弧光保护典型配置	53
1 Typical configuration of arc protection in cable room.....	53
2 典型接线及参数设置	54
2. Typical wiring and parameter settings.....	54
3 弧光保护功能调试	55
3 Arc protection function debugging.....	55
4 维护及常见问题	56
4 Maintenance and common problems	56

第一章 使用说明

Chapter 1 Brief introduction

1 装置介绍

1 Device Introduction

1.1 概述

1.1 Information

ARB4 系列弧光保护装置内部集成电源模块、CPU 模块、弧光采集模块、电流电压采集模块、开入开出模块、通讯模块等硬件电路，集保护、测量、监视、控制、通讯、故障录波、事件记录等多种功能于一体，实时监测弧光信号、保护电流或电压信号，实现 0.4kV~35kV 中低压配电系统的电弧光保护功能。装置软件配以专门的保护算法，抗干扰性能强，可靠性高，保护实现方式灵活，能与 Acrel-2000 电力监控系统配套使用，为电力系统的安全可靠运行提供保障。

The ARB4 series arc protection device integrates hardware circuits such as power module, CPU module, arc light acquisition module, current and voltage acquisition module, input/output module, communication module, etc. It integrates multiple functions such as protection, measurement, monitoring, control, communication, fault recording, event recording, etc. It can monitor arc light signals, protect current or voltage signals in real time, and achieve arc light protection function for 0.4kV~35kV medium and low voltage distribution systems. The device software is equipped with specialized protection algorithms, which have strong anti-interference performance, high reliability, and flexible protection implementation methods. It can be used in conjunction with the Acrel-2000 power monitoring system to provide guarantees for the safe and reliable operation of the power system.

ARB4 系列弧光保护装置操作便捷、资源丰富、稳定可靠、维护方便，广泛应用于电力、水利、交通、工业、矿产、新能源、舰船、建筑楼宇等行业。

The ARB4 series arc protection device is easy to operate, abundant in resources, stable and reliable, and easy to maintain. It is widely used in industries such as electricity, water conservancy, transportation, industry, minerals, new energy, ships, and construction buildings.

1.2 特点

1.2 Feature

➤ 高性能的硬件平台：

High-performance hardware platform

装置采用主频为 550MHz 的处理器，16 位同步采样 A/D，每周波 48 点高速采样、实时并行计算；配置 512K 字节 Flash、(192+4) K 字节 Sram、外置 4M 字节 NorFlash、外置 512K 字节 Sram，硬件资源充足，可靠性高。

The device adopts a processor with a main frequency of 550MHz, 16 bit synchronous sampling A/D, high-speed sampling of 48 points per week, and real-time parallel computing; Configure 512K bytes of Flash, (192+4) K bytes of Sram, external 4M bytes of NorFlash, and external 512K bytes of Sram, with sufficient hardware resources and high reliability.

➤ 完善的保护功能：

Mature and perfect protection function

适用于 35kV 及以下电压等级的电力系统电弧光保护和自动控制功能。装置可实现弧光保护、弧光故障点定位、弧光传感器及光纤链路实时自检、失灵保护、CT 断线监测、非电量保护、装置异常告警、故障录波等功能。

Suitable for arc protection and automatic control functions in power systems with voltage levels of 35kV and below. The device can achieve functions such as arc protection, arc fault point positioning, real-time self inspection of arc probes and fiber optic links, failure protection, CT disconnection monitoring, non electric quantity protection, device abnormal alarm, fault recording, etc.

➤ 丰富的接口资源：

Rich interface resources

4 路交流电流通道的和 3 路交流电压通道；

4 AC current channels and 3 AC voltage channels;

8 路有源开关量输入通道；

8 active switch input channels ;

5 路独立无源开关量输出通道；

5 independent passive switch output channels ;

1 路 RS485 串行通讯接口，支持 IEC60870-5-103、Modbus 规约；

1 RS485 serial communication interfaces, supporting IEC60870-5-103 and Modbus protocols;

➤ 人性化

Humanization

装置采用液晶显示，人机界面清晰易懂。

The device adopts LCD display, and the human-machine interface is clear and easy to understand.

灵活、舒适的按钮设计，菜单式操作简单、便捷。

Flexible and comfortable button design, simple and convenient menu style operation.

保护功能的出口可通过跳闸矩阵进行设置，方便用户选择要动作的继电器。

The outlet of the protection function can be set through the trip matrix, making it convenient for users to choose the relay to operate.

► 透明化：

Transparency

实时记录电流电压值、弧光量、开入量、开出量和所有保护模块的状态。

Real time recording of current and voltage values, arc , input and output, as well as the status of all protection modules.

装置记录内部各元件动作行为、动作时间等信息，并可以查看事件记录（不少于 200 条）、系统记录（不少于 500 条）、操作日志（不少于 2000 条）。

The device records the action behavior and time of various internal components, and can view event records (no less than 200), system records (no less than 500), and operation logs (no less than 2000).

装置记录故障录波信息。16 条故障录波信息，每条录波可触发 4 段录波，每段录波可录故障前 2 个周波、故障后 10 个周波波形。

The device records fault waveform information. 16 fault recording information, each recording can trigger 4 segments of recording, and each segment of recording can record the waveforms of the first 2 cycles of the fault and the last 10 cycles of the fault.

► 高可靠性设计：

High reliability design

装置采用全图形编程技术设计每个保护功能，以提高程序的可靠性及正确性。

The device adopts full graphic programming technology to design each protection function, in order to improve the reliability and correctness of the program.

软硬件具有持续完善的自检功能，抗干扰性能好，装置通过多项电磁兼容检测认证，电快速瞬变脉冲群、静电放电、浪涌抗干扰性能均达到 IV 级标准。

The software and hardware have continuously improved self checking functions, good anti-interference performance, and the device has passed multiple electromagnetic compatibility testing certifications. The electrical fast transient pulse group, electrostatic discharge, and surge anti-interference performance all meet the IV level standard.

1.3 装置选型表

1.3 Device Selection Table

ARB4 系列弧光保护方案，主要由 ARB4 弧光保护装置、ARB-S 弧光传感器及塑料光纤（双股、阻燃）组成。

The ARB4 series arc protection scheme mainly consists of ARB4 arc protection device, ARB-S arc sensor, and plastic optical fiber (double stranded, flame retardant).

1.3.1 弧光保护装置选型表

1.3.1 Selection Table of Arc Protection Device

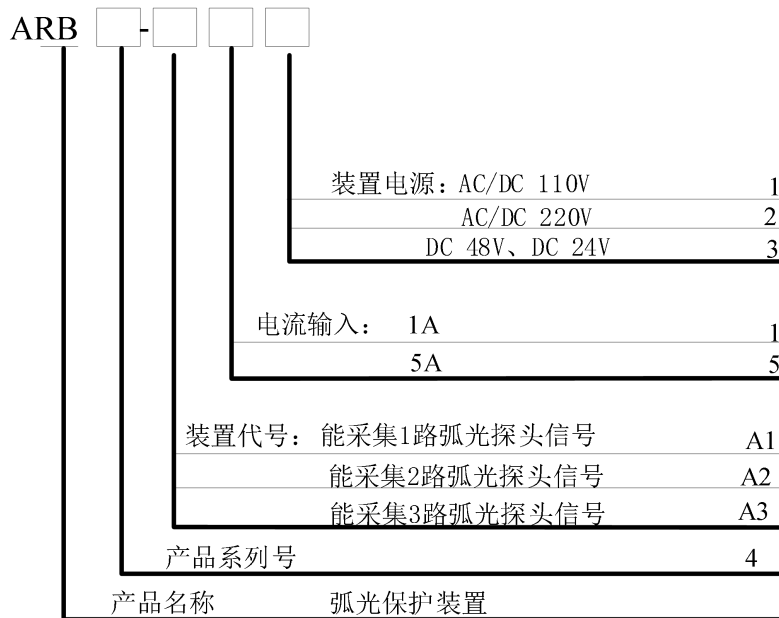

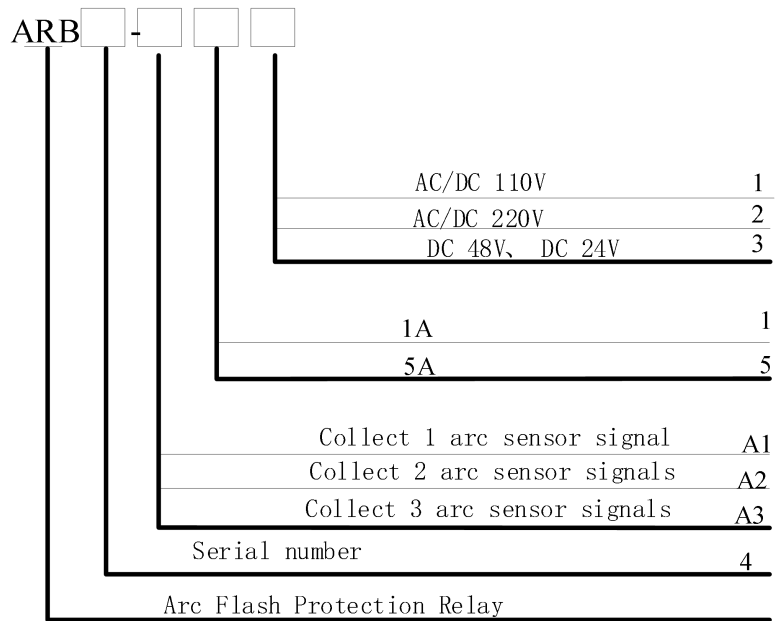

1.3.2 弧光传感器选型表

1.3.2 Selection Table for Arc Sensors

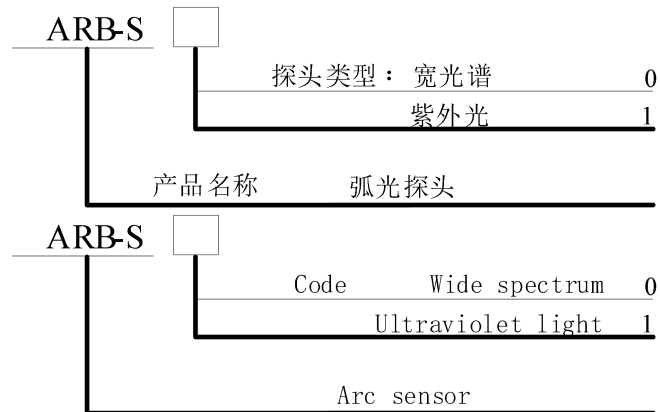

1.4 装置功能对照表

1.4 Selection guide

主要功能 Function		型号 Model	ARB4-A1	ARB4-A2	ARB4-A3
		硬件资源 Hardware	弧光传感器信号采集 Arc sensor signal acquisition	1	2
	电流采集 Current collection	4 路电流通道 4 current channels			

	电压采集 Voltage acquisition	3 路零序电压，共 3 路电压通道 3 zero sequence voltages, a total of 3 voltage channels	
	开入量采集 Digital Input	8	
	继电器输出 Digital Output	5 路常开出口 5 normally open exits	
	1 路 RS485 接口 / B 码对时 1 RS485 interface / IRIG-B	√	
保护功能 Function	弧光保护 Arc protection	弧光单判据 Arc criterion	√
		弧光与电流双判据 Arc&Current criterion	√
		弧光与零序电压双判据 Arc&Voltage criterion	√
	弧光监测及故障点定位 Arc monitoring and fault location	√	
	弧光传感器及光纤链路实时自检 Real time self inspection of arc sensors and fiber optic links	√	
	装置自检及异常告警 Device self-test and abnormal alarm	√	
	CT 断线监测 CT disconnection monitoring	√	
	非电量保护 Non-electricity protection	√	
	失灵保护 Failure protection	√	
	检修状态闭锁 Maintenance status lock	√	
	故障录波 Fault recording	√	
通信规约 Protocol	Modbus	√	
	IEC101	√	
	IEC103	√	
	IRIG-B	√	

注：485 接口与 B 码对时接口复用，只能选其一。

Note: 485 communication interface and IRIG-B interface are multiplexed, only one can be selected.

2 ARB4 装置技术参数

2 ARB4 device technical parameters

2.1 额定参数

2.1 Rated parameters

2.1.1 工作电源

2.1.1 Power supply

额定电压: AC/DC 220V、AC/DC 110V、DC 48V 或 DC 24V

范 围: 额定电压 \times (1 \pm 20%)

功 耗: \leq 15 VA

Power supply: AC/DC220V, AC/DC110V, DC48V ,DC24

Range: Power supply \times (1 \pm 20%)

Maximum power consumption: \leq 15VA

2.1.2 输入激励电压

2.1.2 Rated voltage

额 定 值: 线电压 AC 100V 或相电压 $100/\sqrt{3}$ V

测量范围: 0.1V \sim 120V

准 确 度: \pm 1%

功率损耗: 每相功率损耗不大于 0.5VA

过载能力: 1.4 倍额定电压, 连续工作;

2 倍热过载, 允许 10s。

Rated voltage: AC 100V or $100/\sqrt{3}$ V

Range: 0.1 \sim 120V

Accuracy: \pm 1%

Power consumption: \leq 0.5VA (single phase)

Overload capacity: 1.4 times rated voltage for continuous work;

2 times for 10 seconds.

2.1.3 输入激励电流 (保护电流)

2.1.3 Rated current (Protection current)

额 定 值: AC 5A 或 1A

测量范围: 0.04In \sim 20In

功率损耗：每相功率损耗不大于 0.5VA

过载能力：2 倍额定电流，连续工作；

40 倍额定电流，允许 1s。

Rated current: AC 5A/1A

Range: 0.04In~20In

Power consumption: $\leq 0.5VA$ (single phase)

Overload capacity: 2 times rated current for continuous work;

40 times for 1 second.

2.1.4 频率

2.1.4 Frequency

额定频率：50Hz 或 60Hz

频率范围：40~70Hz

准确度： $\pm 0.1Hz$

Rated frequency: 50Hz or 60Hz

Range: 40~70Hz

Accuracy: $\pm 0.1Hz$

2.1.5 开关量输入

2.1.5 Digital Input

额定电压：AC/DC 220V、AC/DC 110V、DC 48V 或 DC 24V

电压范围：额定电压 $\times (1 \pm 20\%)$

功率消耗：每通道功率消耗 $\leq 1W$ (DC220V)

Rated Voltage: AC/DC220V, AC/DC110V, DC48V, DC24V

Voltage range: Rated Voltage $\times (1 \pm 20\%)$

Power consumption: $\leq 1W$ (DC220V)

2.1.6 开关量输出

2.1.6 Digital Output

机械寿命： ≥ 10000 次

接通容量： $\geq 1000W$, L/R = 40ms

导通电流：连续 $\geq 5A$ ，短时 (200ms) $\geq 30A$

断开容量： $\geq 30W$, L/R = 40ms

Mechanical life: ≥ 10000

Switching capacity: $\geq 1000W$, L/R = 40ms

On current: continuous $\geq 5A$, short time (200ms) $\geq 30A$

Interrupting capacity: $\geq 30\text{W}$, $L/R = 40\text{ms}$

2.2 主要技术性能

2.2 Basic mechanical design feature

电压元件：整定值容许误差应不大于 $\pm 3\%$ ；过压返回系数 0.95，欠压返回系数 1.05。

Voltage element: The allowable error of setting value should not be greater than $\pm 3\%$; the return coefficient of overpressure should be 0.95, and the return coefficient of underpressure should be 1.05.

电流元件：整定值容许误差应不大于 $\pm 3\%$ ；过流返回系数 0.95，欠流返回系数 1.05。

Current element: The allowable error of setting value should not be greater than $\pm 3\%$; the return coefficient of overcurrent should be 0.95, and the return coefficient of undercurrent should be 1.05.

频率元件：整定值容许误差应不大于 $\pm 0.02\text{ Hz}$ 。

Frequency element: The allowable error of setting value should not be greater than $\pm 0.02\text{ Hz}$.

比较元件：过量比较元件返回系数为 0.95，欠量比较元件返回系数 1.05。

Comparison element: Return coefficient is 0.95 or 1.05.

时间元件：延时时间 2s 内，误差 $\leq 40\text{ms}$ ；延时时间大于 2s，误差 $\leq (2\%)$ 整定值 $\pm 40\text{ms}$ 。

Timing element: Delay time within 2 seconds error is $\leq 40\text{ms}$, delay time is more than 2 seconds, error ($\leq 2\%$) tuning value $\pm 40\text{ms}$.

弧光保护动作时间：弧光单判据 $\leq 3.8\text{ms}$ （2 倍弧光动作门槛值，电磁继电器输出）；弧光电流双判据 $\leq 7.8\text{ms}$ （2 倍弧光动作门槛值和 2 倍电流定值，电磁继电器输出）。

Arc protection action time: Arc single criterion $\leq 3.8\text{ms}$ (twice the arc action threshold value, electromagnetic relay output);

Arc current dual criterion $\leq 7.8\text{ms}$ (twice the arc action threshold value and twice the current constant value, electromagnetic relay output).

2.3 正常工作环境条件

2.3 Normal working conditions

环境温度： $-10^{\circ}\text{C} \sim +55^{\circ}\text{C}$ 。

Ambient temperature: $-10^{\circ}\text{C} \sim +55^{\circ}\text{C}$.

装置的贮存、运输允许的环境温度为 $-25^{\circ}\text{C} \sim +70^{\circ}\text{C}$ 。

Device storage, transport allows the ambient temperature is $-25^{\circ}\text{C} \sim +70^{\circ}\text{C}$.

相对湿度：5%~95%（产品内部不凝露，不结冰）。

Relative humidity: 5%~95% (The product does not condensation and freeze inside).

海拔高度： $\leq 2500\text{m}$ 。

Altitude: $\leq 2500\text{m}$.

防护等级：IP20。

Protection level: IP20.

2.4 绝缘性能

2.4 Insulating property

绝缘电阻: >100M Ω , 500Vdc

Insulation resistance: >100M Ω , 500Vdc

介质强度: 回路和地之间, 独立回路之间: 工频耐压 2kV

Dielectric strength: Between the circuit and the ground, between the independent loop: power frequency voltage withstand 2kV

冲击电压: $\pm 5kV(1.2/50 \mu s, 0.5J)$

Impulse voltage: $\pm 5kV(1.2/50 \mu s, 0.5J)$

2.5 电磁兼容性能

2.5 Electromagnetic compatibility performance

	试验项目 Test item	要求 Requirement
1	辐射发射限值检验 Radiation emission limit test	满足 IEC 60255-26:2013 规定 Meet the requirements of IEC 60255-26:2013
2	传导发射限值检验 Conduction emission limit test	满足 IEC 60255-26:2013 规定 Meet the requirements of IEC 60255-26:2013
3	射频电磁场辐射抗扰度 Radio-frequency electromagnetic field radiation immunity	满足 IEC 60255-26:2013 规定, 严酷等级 10V/m Meet the requirements of IEC 60255-26:2013, severity is 10V/m.
4	静电放电抗扰度 Electrostatic discharge immunity	满足 IEC 60255-26:2013 规定, 严酷等级为 IV 级 Meet the requirements of IEC 60255-26:2013, severity is IV level.
5	射频场感应传导骚扰抗扰度 Disturbance immunity of RF Field Induction conduction	满足 IEC 60255-26:2013 规定, 严酷等级骚扰电平 10V Meet the requirements of IEC 60255-26:2013, severe grade disturbance level is 10V.
6	电快速瞬变脉冲群抗扰度 Immunity of electric fast transient pulse group	满足 IEC 60255-26:2013 规定, 严酷等级为 A 级 Meet the requirements of IEC 60255-26:2013, severity is A level.
7	慢速阻尼振荡波抗扰度 Slow-damped oscillation wave immunity	满足 IEC 60255-26:2013 规定, 共模 2.5kV, 差模 1kV Meet the requirements of IEC 60255-26:2013, the common mode is 2.5 and the difference module is 1.
8	浪涌抗扰度 Surge immunity	满足 IEC 60255-26:2013 规定, 严酷等级为 IV 级 Meet the requirements of IEC 60255-26:2013, severity is IV level.
9	交流和直流电压暂降中断影响试验	满足 IEC 60255-26:2013 规定 Meet the requirements of IEC 60255-26:2013

	Effect test of AC and DC voltage sag interruption	
10	工频磁场抗扰度 Power frequency magnetic field immunity	满足 IEC 60255-26:2013 规定，严酷等级为 IV 级 Meet the requirements of IEC 60255-26:2013, severity is IV level.

2.6 阻燃性能

2.6 Flame retardant performance

试验项目 Test item	要求 Requirement
水平燃烧 Horizontal Burning	满足 GB/T 5169.16-2017 规定，严酷等级 HB 级 Meet the requirements of GB/T 5169.16-2017, with a severity level of HB

3 ARB-S 弧光传感器及光纤技术参数



3 ARB-S arc sensor and fiber optic technical parameters

3.1 ARB-S 弧光传感器技术参数

3.1 Technical parameters of ARB-S arc sensor

ARB-S 弧光传感器的监测角度超过 180°，工作温度范围-40° C 至 85° C。

Acceptance cone exceeds 180° spherical with high Homogeneity; Operating temperature range -40° C to 85° C.

	ARB-S0	无源型广角宽光谱弧光传感器（不需电池供电、免维护）； Passive wide-angle broadband arc sensor (battery free, maintenance free); 全绝缘、不含金属成分（没有电气安全隐患）。 Fully insulated, metal free (no electrical safety hazards).
	ARB-S1	无源型广角紫外光弧光传感器（不需电池供电、免维护）； Passive wide-angle ultraviolet arc sensor (battery free, maintenance free); ST 标准接口。 ST standard interface.

Acceptance Cone

Minimum 180° spherical.

Figure 1 Typical Acceptance Cone

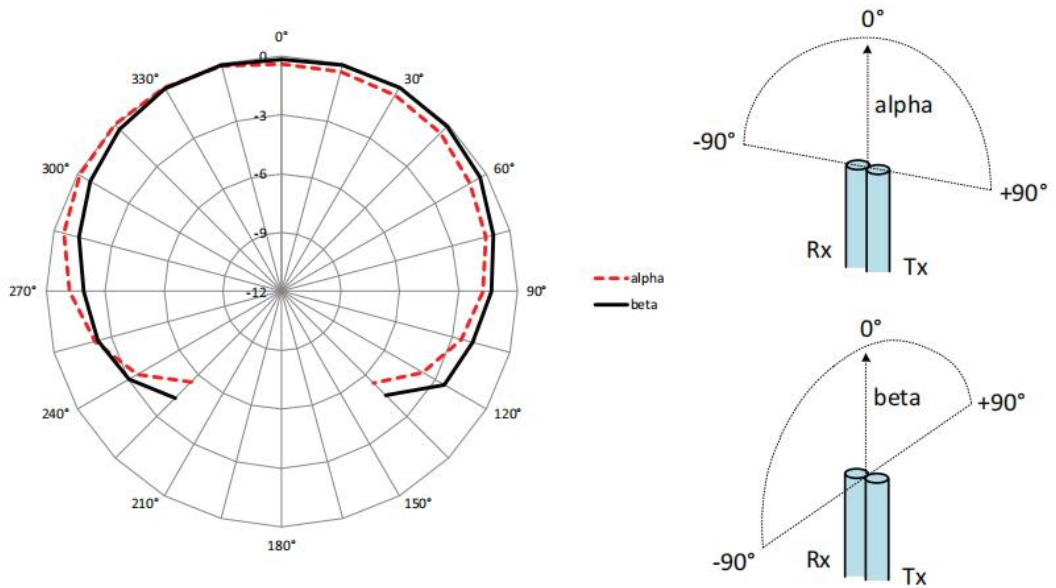

NOTE The values in the vertical axis are in dB.

图 3.1 ARB-S0 弧光传感器监测范围角度

Figure 3.1 ARB-S0 Acceptance Cone



图 3.2 ARB-S1 弧光传感器监测范围角度

Figure 3.2 ARB-S1 Acceptance Cone

3.2 双股塑料光纤技术参数

3.2 Technical parameters of double core plastic optical fiber

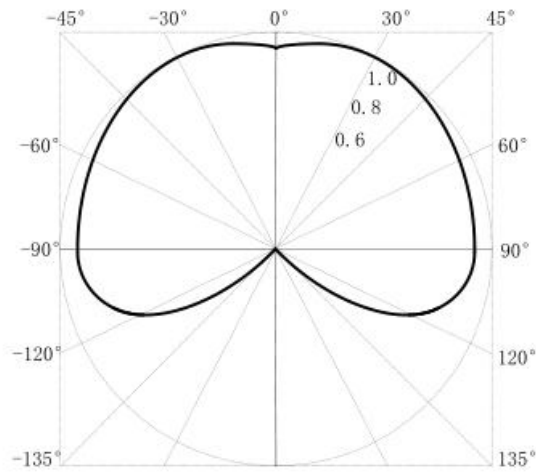
光纤工作温度范围-55° C 至 70° C。

Operating temperature range - 55° C to 70° C.

项目(Item)		技术参数 (Technical parameter)	说明(Notes)
光学性能 Optical performance	衰减 (Attenuation)	@650nm	≤160dB/km
塑料光纤 Plastic optical fiber	纤芯材料 (Core material)	聚甲基丙烯酸甲酯(PMMA)	
	包层材料 (Cladding material)	氟化高聚物(Fluorinated polymer)	
	纤芯折射率 (Core refractive index)	1.49	
	包层折射率 (Cladding refractive index)	1.41	
	数值孔径 (Numerical aperture)	0.5	
	纤芯直径 (Core diameter)	980±60	μm
	包层直径 (Cladding diameter)	1000±60	μm
	纤芯数量 (Number of cores)	2	cores
护套 Jacket	尺寸 (Dimensions)	短边 (Short side)	2.2±0.07 mm
		长边 (Long side)	4.4±0.14 mm
	颜色 (Colour)	黑色(Black)	
	阻燃等级 (Flame retardant grade)	VW-1	
产品标准(Product standard)		ROHS,REACH,SGS, (YD/T 1447-2013)	

4 开孔尺寸和安装位置

4 Hole size and installation position



图 4.1 弧光保护装置、弧光传感器及光纤实物图

Figure 4.1 Actual diagram of arc protection device, arc sensor, and optical fiber

4.1 装置开孔尺寸和安装位置

4.1 Device opening size and installation position

4.1.1 装置外形图和开孔尺寸

4.1.1 Device Outline Drawing and Opening Dimensions



图 4.2 弧光保护装置外形及开孔尺寸图

Figure 4.2 Outline and Opening Dimensions of arc Protection Device

注：开孔尺寸以毫米（mm）为单位。

Note: The size of the opening is in millimeters (mm).

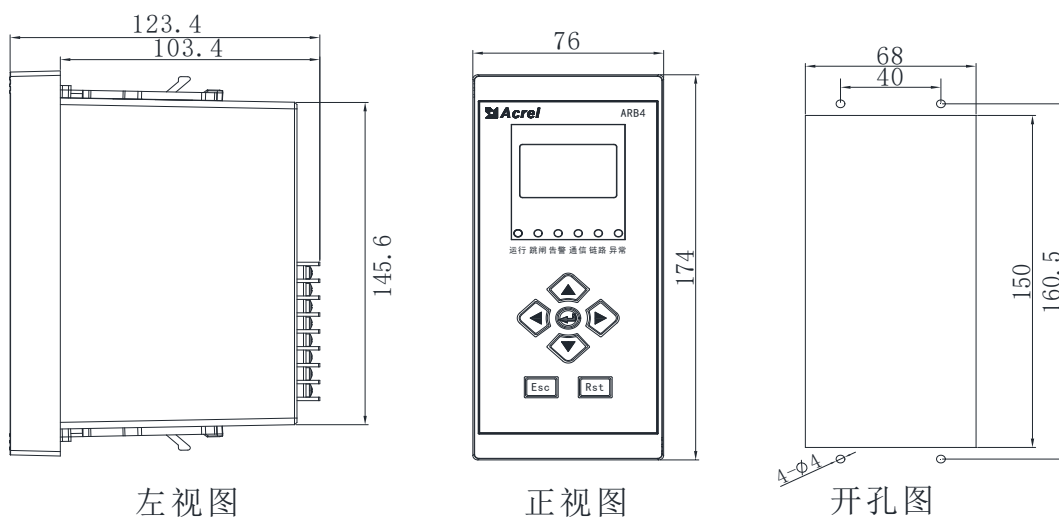
4.1.2 装置安装位置

4.1.2 Installation position of the device

弧光保护装置安装时需考虑开关柜安装空间，与保护范围内的 TA 回路连接、保护跳闸回路连接，原则上采用就近安装方式，避免 TA 采集回路、跳闸回路连线过长，采用面板开孔安装。

When installing the arc light protection device, the installation space of the switchgear should be considered, and it should be connected to the TA circuit within the protection range and the protection tripping circuit. In principle, the installation method should be nearby to avoid the TA acquisition circuit and tripping circuit wiring being too long. Panel opening installation should be adopted.



图 4.3 弧光保护装置安装示意图

Figure 4.3 Installation diagram of arc protection device

4.2 传感器开孔尺寸和安装位置

4.2 Sensor hole size and installation position

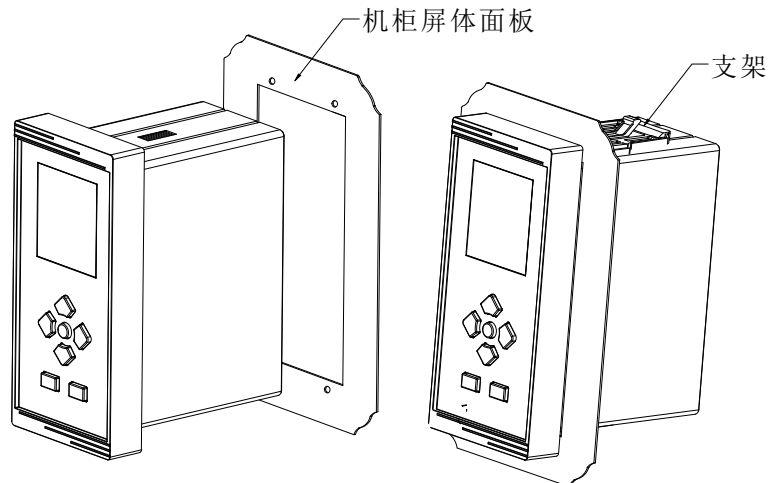
4.2.1 传感器外形图和开孔尺寸

4.2.1 Sensor Outline Drawing and Opening Dimensions

弧光传感器配套卡扣支架使用，卡扣支架需要开孔安装。卡扣支架的开孔尺寸为 20mm（直径）。

The arc sensor is equipped with a buckle bracket, which needs to be installed with holes. The opening size of the buckle bracket is 20mm (diameter).



图 4.4 弧光传感器外形及开孔尺寸图

Figure 4.4 Appearance and Opening Dimensions of Arc Sensor

4.2.2 传感器安装位置

4.2.2 Sensor installation position

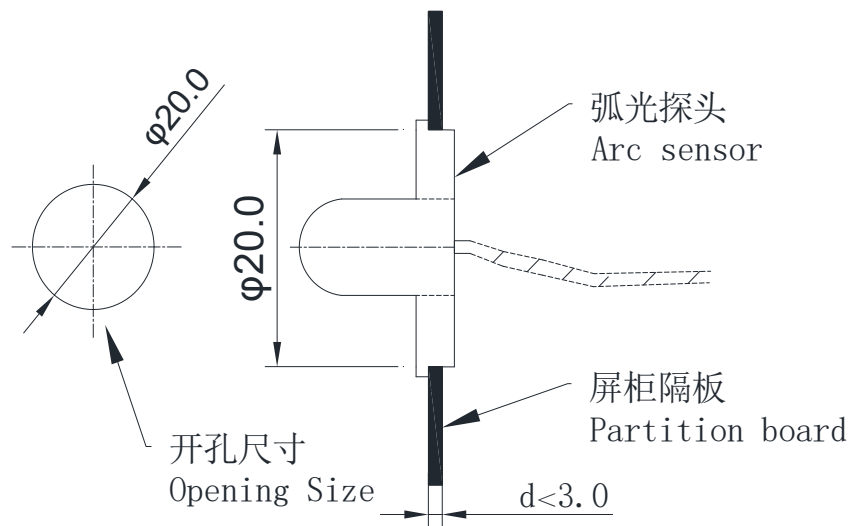
弧光传感器的检测范围是一个角度为 180° ，半径 0.5m 的扇形区域，所以选择传感器

安装点时应充分考虑该要素，避免出现检测盲区。

The detection range of the arc sensor is a fan-shaped area with an angle of 180° and a radius of 0.5m. Therefore, when selecting the sensor installation point, this element should be fully considered to avoid blind spots in detection.

弧光传感器安装应遵循以下原则：

The installation of arc sensors should follow the following principles:

弧光传感器建议安装地点包括（但不限于）母线室、断路器室、电缆室。

The recommended installation locations for arc sensors include (but are not limited to) busbar rooms, circuit breaker rooms, and cable rooms.

在开关柜有断路器的情况下，弧光传感器建议安装容易产生电弧的位置（如：在母线触头连接处、上或下隔离开关（2处）触头处、电流互感器触头处、电缆接头处）。在开关柜无断路器的情况下，弧光传感器建议安装在母线触头连接处、上和下隔离开关触头处（1处）、电缆接头处。

In the case of a circuit breaker in the switchgear, it is recommended to install the arc sensor in a location that is prone to arc generation (such as at the connection of the busbar contact, the contact of the upper or lower isolation switch (2 positions), the contact of the current transformer, and the cable joint). In the absence of a circuit breaker in the switchgear, it is recommended to install the arc sensor at the busbar contact connection, upper and lower isolation switch contacts (1 point), and cable joints.

封闭式母线桥架在桥架两端需要安装弧光传感器。若考虑实现开关柜的整体保护，可以在开关柜的断路器室和电缆室各安装1个弧光传感器。

A closed busbar bridge requires the installation of arc sensors at both ends of the bridge. If considering the overall protection of the switchgear, one arc sensor can be installed in each of the circuit breaker room and cable room of the switchgear.

弧光传感器安装示例如下。

The installation example of the arc sensor is as follows.

1) 母线室

1) Busbar compartment

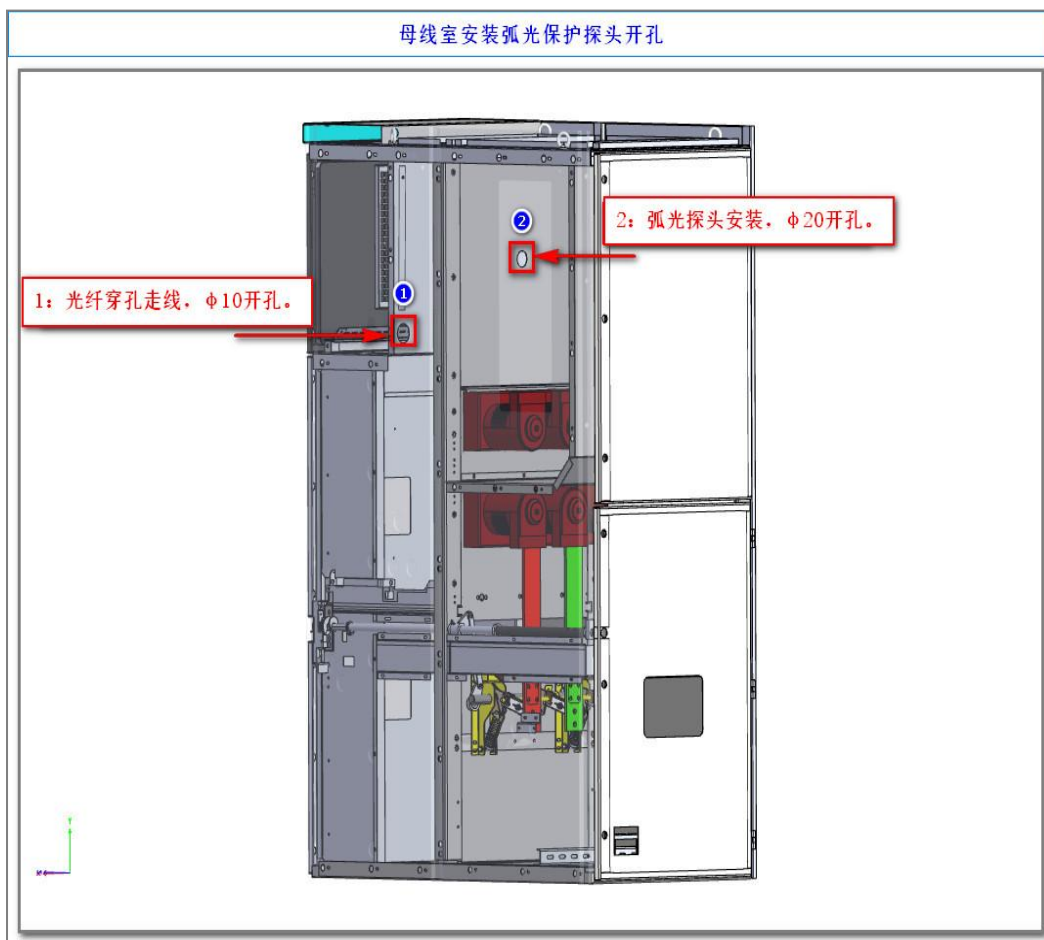

也可如下图安装，B 点是母线室散热窗附近，在这个点位开孔安装弧光传感器，塑料光纤在柜顶引至 C 点进入仪表室，再到达 D 点附近，经开关柜二次电缆穿线孔汇集至弧光保护装置。

It can also be installed as shown in the figure below. Point B is near the heat dissipation window of the busbar room. At this point, an arc sensor is installed by opening a hole. The plastic fiber optic cable is led from the top of the cabinet to point C and enters the instrument room, then reaches point D and converges to the arc protection device through the secondary cable threading hole of the switchgear.

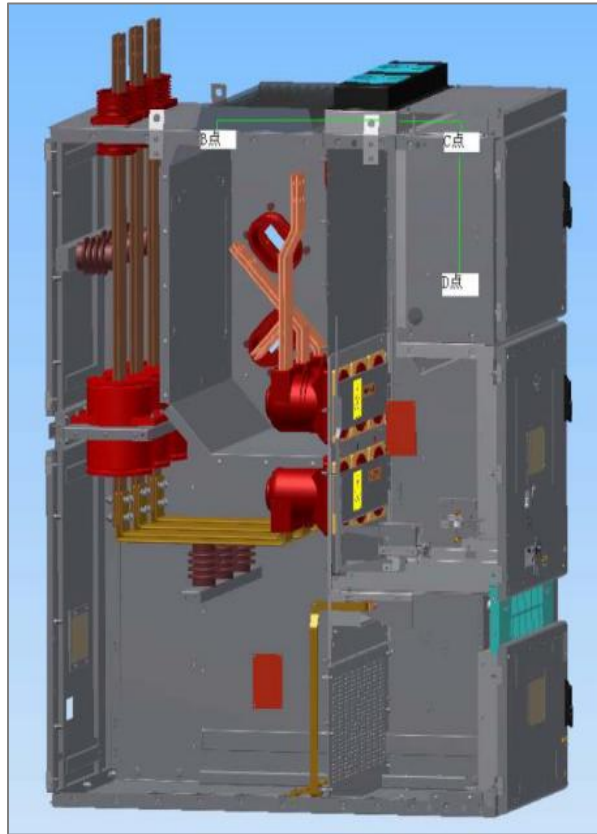

2) 手车室

2) Handcart room

手车室安装弧光保护开孔图

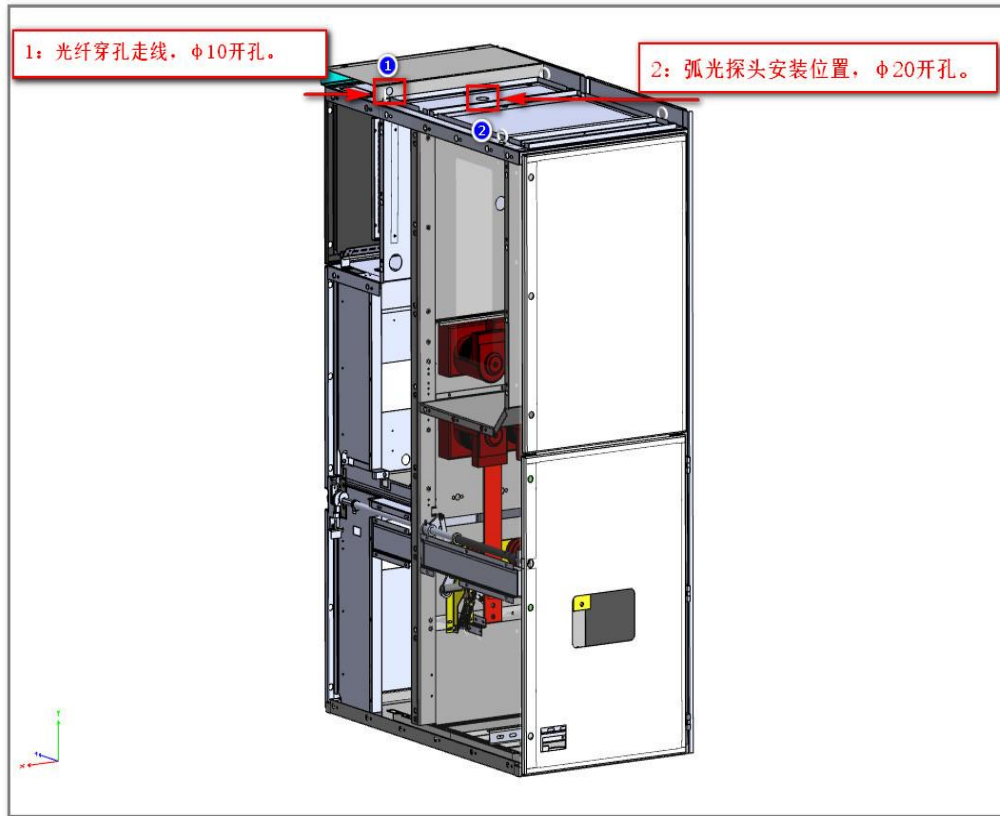

3) 电缆室

3) Cable room

电缆室安装弧光保护探头开孔

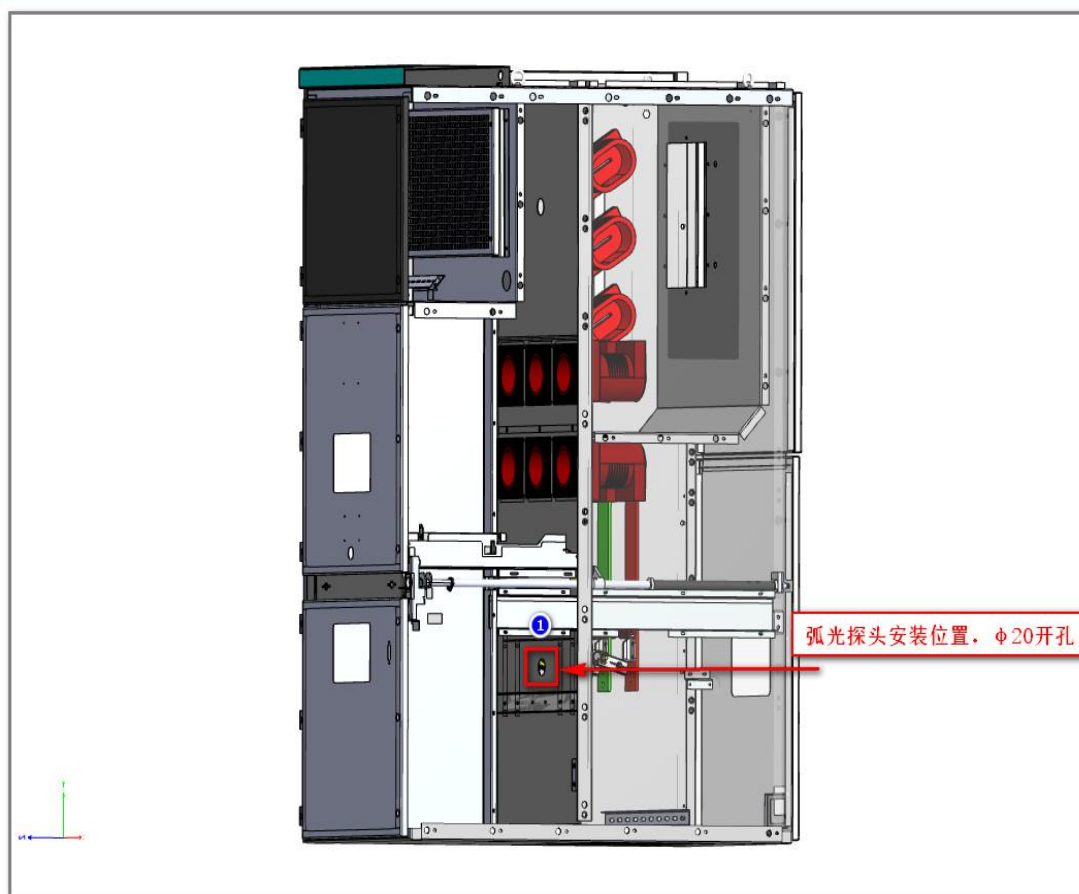

4.3 施工注意事项

4.3 Construction precautions

弧光传感器与弧光保护装置之间通过光纤连接，施工时应注意如下事项。

The arc sensor and arc protection device are connected through optical fibers, and the following precautions should be taken during construction.

(1) 光纤应避免在电缆沟或电缆桥架中敷设，不建议从开关柜现有的缝隙或螺孔穿过，如果通过缝隙或螺孔穿过，应做好孔的绝缘和保护工艺，避免屏体锐角对光纤造成损伤；

(1) Fiber optic cables should be avoided from being laid in cable trenches or cable trays. It is not recommended to pass through existing gaps or screw holes in the switchgear. If passing through gaps or screw holes, insulation and protection processes for the holes should be done to avoid damage to the fiber optic cables caused by sharp corners of the screen;

(2) 光纤敷设应远离母线、断路器触头及电缆接头等高压设备；

(2) Fiber optic cables should be laid away from high-voltage equipment such as busbars, circuit breaker contacts, and cable joints;

(3) 光纤敷设时必须考虑固定原件脱离时不能直接搭接至高压电气部分，防止光纤表

面积尘产生爬电现象；

(3) When laying optical fibers, it is necessary to consider that when the fixed components are detached, they cannot be directly overlapped to the high-voltage electrical part to prevent the phenomenon of crawling caused by dust on the surface of the optical fibers;

(4) 弧光传感器安装位置和角度应考虑环境污染影响，应避免弧光传感器感光面前方的各种遮挡和直射光源；

(4) The installation position and angle of arc sensors should consider the impact of environmental pollution, and avoid various obstructions and direct light sources in front of the arc sensor's photosensitive surface;

(5) 光纤建议采用点位片或扎带固定；

(5) Fiber optic cables are recommended to be fixed with point patches or ties;

(6) 光纤弯曲走线时应保持一定的弧度，弯曲半径不小于 10cm。

(6) When bending and routing optical fibers, a certain degree of curvature should be maintained, and the bending radius should not be less than 10cm.

其他安装事宜，请参阅《NB/T 42076-2016 弧光保护装置选用导则》中的“附录 B 弧光保护装置典型安装”章节。

For other installation matters, please refer to the "Appendix B Typical Installation of Arc Protection Devices" section in the "NB/T 42076-2016 Arc Protection Device Selection Guidelines".

5 装置操作说明

5 Operational Manual

5.1 前面板说明

5.1 Surface

装置的人机交互主要在面板上进行，包括三个部分：液晶显示、LED 灯指示和按键。

The human-computer interaction of the device is mainly carried out on the panel, including three parts: LCD display, LED light indication, and buttons.

液晶显示屏采用 128*64 点阵，可以显示弧光强度、电流、电压等遥测量值、遥信量、事件记录、通信参数、定值参数、装置时间、装置版本号信息等。

The LCD display screen adopts a 128 * 64 dot matrix, which can display remote measurement values such as arc intensity, current, voltage, remote signal quantity, event recording, communication parameters, fixed value parameters, device time, device version number information, etc.

LED 灯用来指示装置的运行状态、跳闸、告警、通信、链路、异常等信息，也可根据用户需要进行定制，图 5.1 中为出厂默认配置。

LED lights are used to indicate the operating status, tripping, alarm, communication, link, abnormality, and other information of the device. They can also be customized according to user needs. Figure 5.1 shows the factory default configuration.



图 5.1 ARB4 前面板
Figure 5.1 ARB4 Front Panel

5.2 按键说明

5.2 Key instructions

按键包括上、下、左、右、确认键、返回键及复归键，实现人机交互功能。

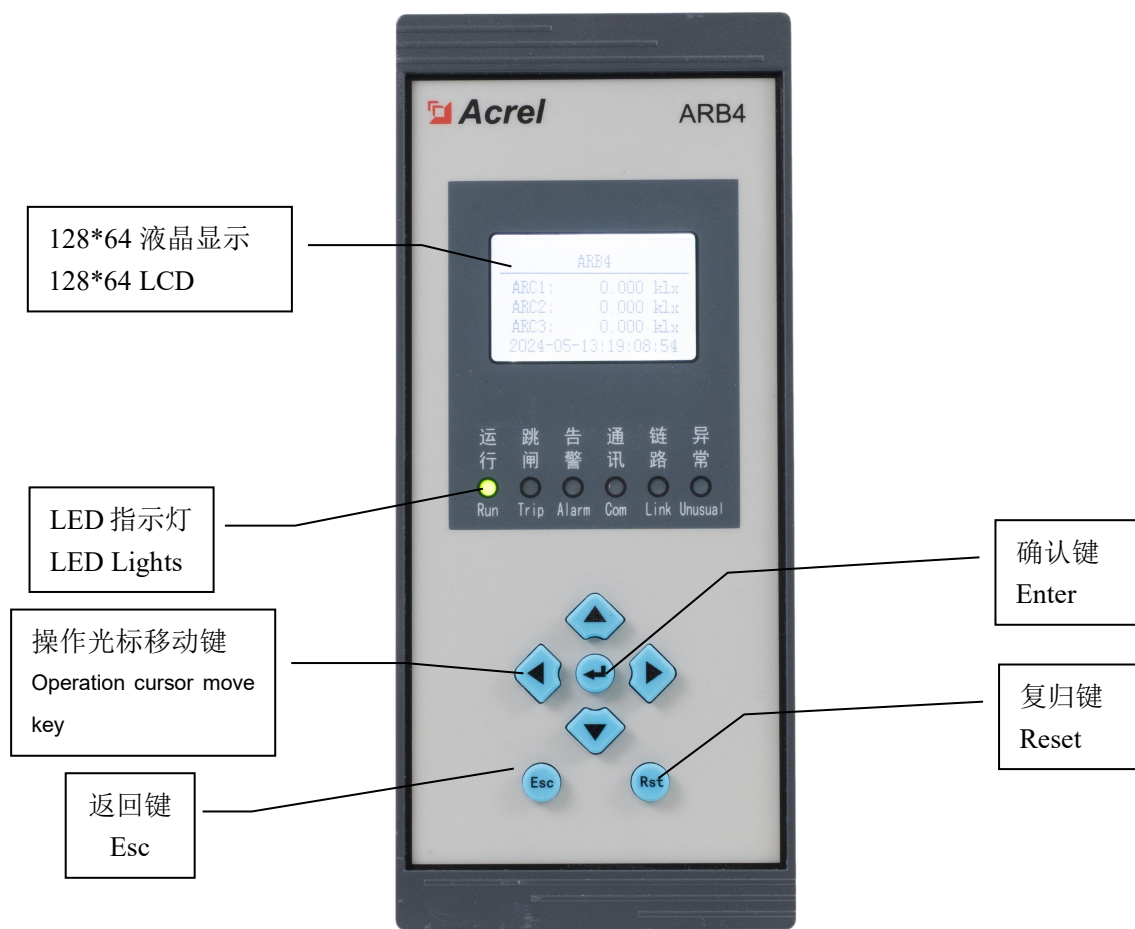
The keys include up, down, left, right, enter, return and function keys to realize human-computer interaction.

表 5.2 ARB4 按键功能说明

Table 5.2 ARB4 Key Function Description

按键 Key	主要功能 Function	按键 Key	主要功能 Function
	确认 Enter		向上移动选项或数字增大 Up/Increase
	复归 Reset		向下移动选项或数字减小 Down/Decrease
	返回 Esc		向左移动选项或页面前翻 Left/Page forward
			向右移动选项或页面后翻 Right/Page back

5.3 菜单说明

5.3 Menu instructions

装置上电即进入主界面，主界面分四个界面显示：运行界面、遥测界面、遥信界面、出口映射界面，如图 5.2~5.5 所示。各个界面之间可以通过左右键来切换显示。

When the device is powered on, it enters the main interface, which is divided into four interfaces for display: operation interface, telemetry interface, remote signaling interface, and exit mapping interface, as shown in Figures 4.2-4.5. The display can be switched between different interfaces through left and right keys.

ARB4	
ARC1	0.000 klx
ARC2	0.000 klx
ARC3	0.000 klx
2000-01-01 00:00:00	

图 5.2 运行界面

Figure 5.2 Running Interface

遥测			RemoteMeter		
ARC1	0.000	klx	ARC1	0.000	klx
ARC2	0.000	klx	ARC2	0.000	klx
ARC3	0.000	klx	ARC3	0.000	klx
Ia	0.000	A	Ia	0.000	A

图 5.3 遥测界面

Figure 5.3 Telemetry Interface

遥信		ReoteSignal	
检修状态	分	Maintenance	OFF
远方指示	分	Remote	OFF

图 5.4 遥信界面

Figure 5.4 Remote Communication Interface

出口映射		DO Mapping	
第1组弧光保护	00000	ArcGroup1	00000
第2组弧光保护	00000	ArcGroup2	00000
第3组弧光保护	00000	ArcGroup3	00000
第1组失灵保护	00000	Faiure. P1	00000

图 5.5 出口映射界面

Figure 5.5 Export Mapping Interface

出口映射界面中，保护出口与开出继电器的映射关系如下表中 1-16 位二进制数表示。

In the export mapping interface, the mapping relationship between the protection export and the output relay is represented by a 1-16 bit binary number in the table below.



1	2	3	4	5
0	0	0	0	0

第 1~5 位分别表示无源开出 DO1~DO5（常开接点）。若序号 1~5 中某位为 1 时，表示保护功能动作（跳闸或者告警）配置到该出口；若为 0 时，表示未配置到该出口。

The first to fifth digits represent passive output of DO1 to DO5 (normally open contact). If one of the digits in numbers 1 to 5 is 1, it indicates that the protection function is activated (tripped or alarmed) and configured to that exit; If it is 0, it indicates that the exit has not been configured..

5.3.1 快速导航

5.3.1 Fast navigation

装置菜单为多级菜单，在任一幅主界面里按“”确认键即进入主菜单，主菜单分为 8 个子菜单，如图 5.6，由子菜单名称、图标构成。选定任一子菜单后按“”确认键进入菜单，按“”返回键返回上级菜单。图 5.7 为装置的快速导航示意图，可以依据该图迅速查找相关参数。

The device menu is a multi-level menu. Press the confirm button in any main interface to enter the main menu. The main menu is divided into 8 sub menus, as shown in Figure 5.6, consisting of sub menu names and icons. After selecting any submenu, press the confirm button to enter the menu, and press the return button to return to the higher-level menu. Figure 5.7 is a quick navigation diagram of the device, which can be used to quickly search for relevant parameters.



图 5.6 主菜单
Figure 5.6 Main Menu







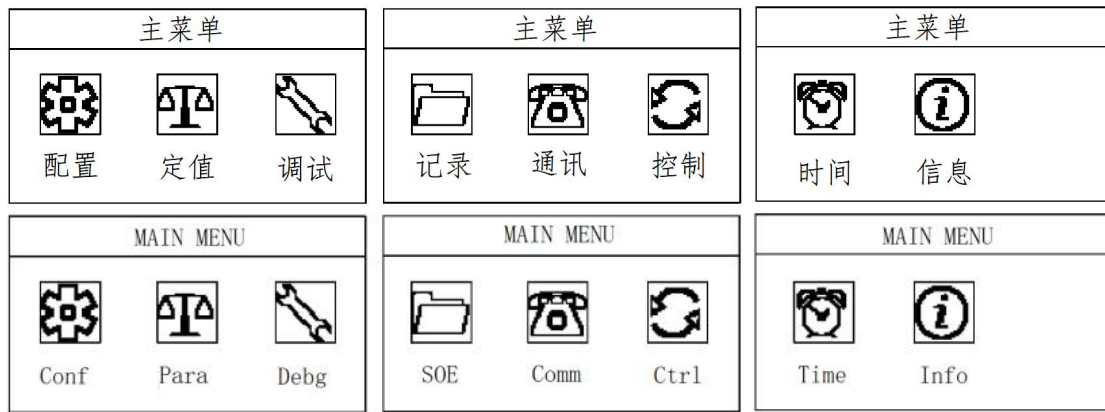
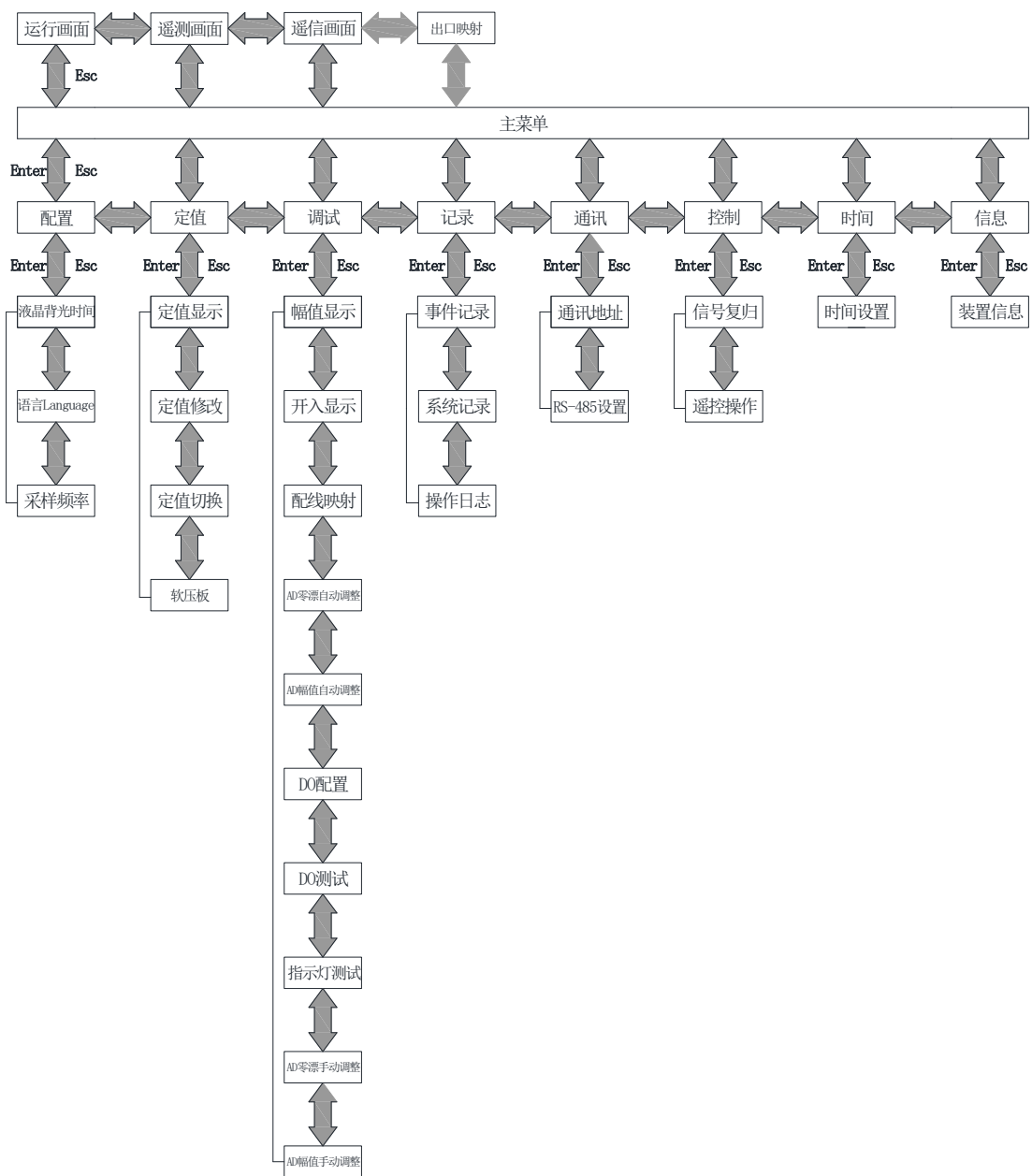

图 5.7 快速导航示意图

Figure 5.7 Quick Navigation Diagram

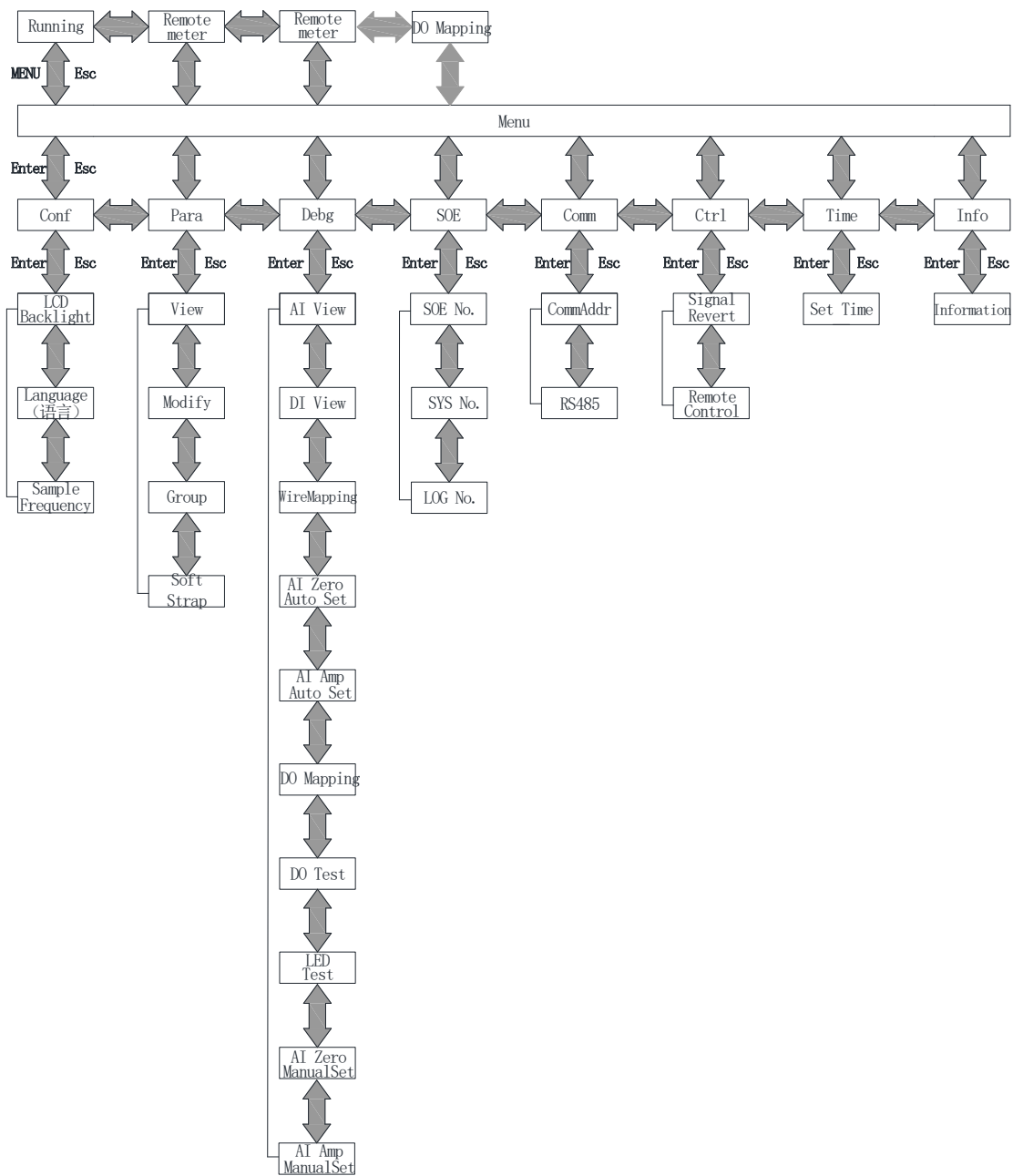
5.3.2 配置

5.3.2 Configuration

“配置”菜单可以设置液晶背光时间、语言、采样频率，如图 5.8，修改完成后，按“”确认键退出修改，再按“”返回键返回，装置会跳出数据保存界面，如图 5.9，按“”

确认键保存修改并返回主菜单，按“**Esc**”返回键不保存修改且返回主菜单。该菜单**初始密码**为“0008”。

The "Configuration" menu can set the LCD backlight time, language, and sampling frequency, as shown in Figure 5.8. After the modification is completed, press the "Confirm" button to exit the modification, and then press the "Return" button to return. The device will pop up the data saving interface, as shown in Figure 5.9. Press the "Confirm" button to save the modification and return to the main menu. Press the "Return" button to not save the modification and return to the main menu. The initial password of this menu is “0008”.

配置		CONF	
液晶背光时间	060秒	LCD Backlight	060S
语言 (Language)	中文	语言 (Language)	ENGLISH
额定频率	50Hz	Sample Freq	50Hz

图 5.8 液晶背光时间设置

Figure 5.8 LCD backlight time setting

配置		CONF	
液晶背光时间	060秒	LCD Backlight	060S
 Enter: 保存	Esc: 退出	 Enter: Save	Esc: Exit

图 5.9 数据保存提示

Figure 5.9 Data saving

5.3.3 定值

5.3.3 Parameter

“定值”菜单里有定值显示、定值修改、定值切换、软压板投退四个子菜单，如图 5.10。

The "Para." menu has four sub menus: Value View, Value modify, Switch Group, and Soft Strap, as shown in Figure 5.10.



定值	PARA
定值显示	Value View
定值修改	Value Modify
定值切换	Switch Group
软压板	Soft Strap

图 5.10 定值菜单

Figure 5.10 Parameter

5.3.3.1 定值显示

5.3.3.1 Value View

“定值显示”菜单中有选择定值区、运行定值区两个子菜单。选择定值区里有四组有效定值，分别为00、01、02、03四个区号，选择相应区号，如图5.11，按“”确认键进入定值显示。所有定值分页显示，按“”左、“”右键可分页查看，如图5.12。运行定值区里显示装置当前运行的定值区。

The "Value View" menu has two submenus, which are selected value section and running value section. The selected value section has 4 section:00,01,02 and 03,as shown in figure5.11. Each section can be set different values. The running value section is shown the nowadays value, all value pagination displays, press left and right key to view, as shown in figure 5.12.

定值区	Value Group
选择定值区:00	Selected:0 0
运行定值区:00	Running:00

图 5.11 设置选择定值区
Figure 5.11 Selection area









定值显示[00] (001)	View[00] (001)
电流接线方式	CT Mode
3CT	3CT
额定二次电流 (Ie)	5.000A
5.000A	5.000A

图 5.12 定值显示
Figure 5.12 View

5.3.3.2 定值修改

5.3.3.2 Modify

“定值修改”菜单有选择定值区、运行定值区两个子菜单，该菜单初始密码为“0008”。
The “Modify” menu has two submenus in the selected value area and the running value area. The initial password of this menu is “0008”.

在选择定值区内设置需修改的定值区号，按“”确认键进入定值修改界面。这里分页显示所有定值信息，可通过“”上、“”下、“”左、“”右键选择需修改的定值，先按“”确认键，再按“”上、“”下设置修改内容，如图5.13-5.14。修改完成后，按“”确认键确定，再对下一个需修改的定值进行修改，待全部定值修改

完成后，再按“Esc”返回键退出，这时若数据有改动，则装置会弹出同图 5.9 所示的数据保存对话框，按“”确认键保存修改并返回定值管理菜单，按“Esc”返回键不保存且返回定值管理菜单。

Set the value area code to be modified in the fixed value area, and press “Enter” to enter the value modification interface. Here pagination displays all the value information, and use can select the value that needs to be modified by selecting the left and right keys, press the “Enter” button first, and then press the up and down key to set the modified content, as shown in figure 5.13-5.14. After the set is completed, press the “Enter” button, then set the next one as the same way.

When the all setting is completed, press “Esc” button to exit, at this time if the data changes, the device will pop up with the data dialog box shown in figure 5.9, press “enter” button to save the changes and return to value management menu, click “Esc” button is not saved and to return to value management menu.

运行定值区只显示装置当前运行的定值区号，这里不做修改。

The running value area only displays the current running value area of the device. and no modification is made here.



图 5.13 输入密码对话框

Figure 5.13 entering password

定值修改[00]	(001)	Modify[00]	(001)
电流接线方式	3CT	CT Mode	3CT
额定二次电流 (Ie)	5.000A	Ie	5.000A

图 5.14 定值修改

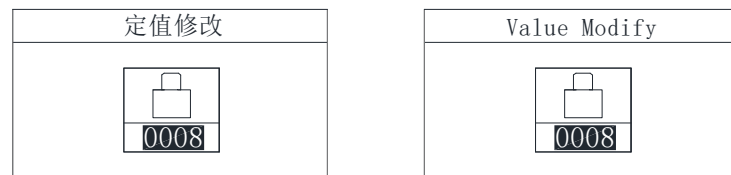
Figure 5.14 Value Modify

5.3.3.3 定值切换

5.3.3.3 Switch Group

“定值切换”菜单有切至定值区、运行定值区两个子菜单，该菜单初始密码为“0008”。

切至定值区内有 00-03 四个有效定值区可供切换，设置好后，按“”确认键确定，再按“Esc”返回键返回主菜单。运行定值区将显示当前运行的定值区号，如图 5.15。

The “Switch Group” menu has two sub-menus: selected value section and running value section. The password of this menu is “0008”. The selected section shows the expected section













users want to set, which can be set as 00-03. After making the selection, press the“Enter”button to determine, and then press the“esc” key to return to the main menu. The running value section will display the current running value area of the device, as shown in Figure 5.15.

定值切换	Group
切至定值区:00	Selected:00
运行定值区:00	Running:00

图 5.15 定值切换
Figure 5.15 Switch Group

5.3.3.4 软压板

5.3.3.4 Soft Strap

“软压板”菜单初始密码为“0008”，按“”确认键进入软压板投退修改界面。这里分页显示所有软压板投退信息，可通过“”上、“”下、“”左、“”右键选择需修改的软压板，先按“”确认键，再按“”上、“”下设置修改内容，如图 5.16-5.17。修改完成后，按“”确认键确定，再对下一个需修改的软压板进行修改，待全部定值修改完成后，再按“”返回键退出，这时若数据有改动，则装置会弹出同图 5.9 所示的数据保存对话框，按“”确认键保存修改并返回定值管理菜单，按“”返回键不保存且返回定值管理菜单。

The password for the "Soft Strap" menu is "0008". Press the confirmation button to enter the Soft Strap interface. Here, all the input and output information of the Soft Strap is displayed in pages. You can select the Soft Strap to be modified by pressing the "up", "down", "left", and "right" buttons. First, press the "confirm" button, and then press the "up" and "down" buttons to set the modification content, as shown in Figure 5.16-5.17. After the modification is completed, press the confirm button to confirm, and then modify the next Soft Strap that needs to be modified. After all fixed are completed, press the return button to exit. If there are any changes to the data, the device will pop up a data saving dialog box as shown in Figure 5.9. Press the confirm button to save the modifications and return to the main menu. Press the return button to not save and return to the main menu.



图 5.16 输入密码对话框

Figure 5.16 entering password

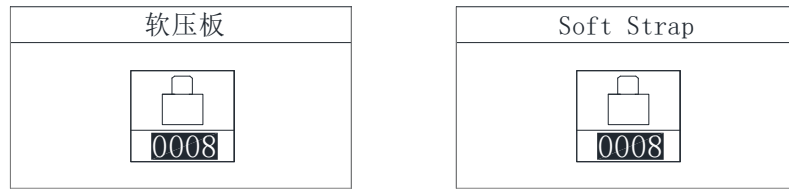

图 5.17 软压板投退修改

Figure 5.17 Soft Strap modify

5.3.4 调试

5.3.4 Debugging

“调试”菜单用于装置出厂前的测试，可对装置进行零漂调整、幅值调整、继电器输出测试、继电器输出配置、指示灯输出测试等配置。

The "Debug" menu is used for pre factory testing of the device, which can be configured for zero drift adjustment, amplitude adjustment, relay output testing, relay output configuration, indicator light output testing, etc.

该菜单功能使用时请与制造商联系。

Please contact the manufacturer when using this menu function.

5.3.5 记录

5.3.5 Record

“记录”菜单中可以查看事件记录、系统记录、操作日志三类信息。

In the "REC" menu, users can view three types of information: SOE Record、SYS Record and LOG Record.

5.3.5.1 事件记录

5.3.5.1 SOE Record

“事件记录”菜单可显示事件序号、事件总数、事件代码、事件发生时间、事件名称、动作类型（动作或告警）等信息。如果是保护动作引起的事件记录，还会记录事件发生时刻动作元件动作值和时间，如图 5.18 所示。装置可保存不少于 200 条事件记录。

The "SOE Record" menu displays the event sequence, total number of events, event code, event time, event name, action type (action or alarm), and other information. If the event is caused by a protection action, the action value and time of the action element at the time of the event are also recorded, as shown in Figure 5.18. The device can save over 200 event records.

	事件记录	[002/026]	事件序号 事件总数
事件发生时间	19-10-21	09:48:57.619	
	事件代码	(6001)	
事件名称	第1组弧光保护	[动作]	
	事件参数见下一页		

	SOE	[002/026]	NO. All
Time	19-10-21	09:48:57.619	
	Event Code	(6001)	
Event	1. ARC	[Set]	
	SOE Par. on Next Page		

图 5.18 事件记录画面
Figure 5.18 Event record screen

5.3.5.2 系统记录

5.3.5.2 SYS Record

“系统记录”菜单可显示系统记录序号、系统记录总数、系统记录时间、系统记录名称、系统记录码等信息，如图 5.19 所示。装置可保存不少于 500 条系统记录。

The "SYS Record" menu displays the system records sequence, total number of system records, system records time, system records name, system records code and other information, as shown in Figure 4.19. The device can save more than 500 records.

系统记录	[012/076]
19-11-14	09:44:05.000
文件初始化	
硬件属性	
事件代码:0x000006	

SYS REC	[012/076]
19-11-14	09:44:05.000
File open	
. HRD	
Code:0x000006	

5.19 系统记录画面
Figure 5.19 System record screen

5.3.5.3 操作日志

5.3.5.3 Log Record

如图 5.20 所示，“操作日志”菜单记录装置所有的操作行为、设置变更行为等信息。装置可保存不少于 2000 条系统记录。

As shown in Figure 5.20, the "Log REC" menu records all operation and setting changes of the device. The device can save more than 2000 records.

操作日志 [001/099]	LOG REC [001/099]
20000002-060652.001 升级程序	20000002-060652.001 DEVICE UPGRADE

图 5.20 操作记录画面
Figure 5.20 Log record screen

5.3.6 通讯

5.3.6 Communication

“通讯”菜单可设置通讯地址及波特率，如图 5.21-5.23。通讯参数可从表 5.3 选择参数进行设置。设置完成后先按“Esc”返回键退出，然后按“Enter”确认键保存，再按“Esc”返回键返回主菜单。该菜单初始密码为“0008”。

In "Comm", the communication address and baud rate of relay can be set, as shown as figure 5.21-5.23. Communication parameters can be modified according to table 5.3. After modification, users can quit by the "Esc" key, save the modification by the "Enter" key, and return to the main menu by the "Esc" key. The initial password of this menu is "0008".

表 5.3 通讯参数设置

Table 5.3 Communication parameter

设置量 Setting parameter	参数 Parameter
装置地址 Relay address	0~255
比特率 Baud rate	4800、9600、14400、19200、38400、56000、57600
数据位 Date bits	8、9
停止位 Stop bit	1、1.5、2
校验方式 Calibration method	无校验、偶校验、奇校验 None、Even、Odd
规约选择 Statutory choice	MODBUS、IEC101、IEC103、IRIG_B、LoopBk

通讯	COMM
通讯地址	CommAddr
RS485设置	RS485

图 5.21 通讯设置界面
Figure 5.21 Communication setting

通讯地址	
装置地址	00000

CommAddr	
CommAddr	00000

图 5.22 通讯地址界面

Figure 5.22 Device address setting

RS485设置	
规约	IEC103
波特率	38400
数据位	8
停止位	1

RS485	
Protocol	IEC103
Baudrate	38400
DateBit	8
StopBit	1

图 5.23 RS485 设置界面

Figure 5.23 RS485 setting

5.3.7 控制

5.3.7 Control

“控制”菜单用于装置出厂前的测试，可对装置进行遥控分闸、遥控合闸及信号复归操作。



The "Control" menu is used to test the device before it leaves the factory, which allows remote control of the device for breaking, closing, and signal restoration operations.

该菜单功能使用时请与制造商联系。

Please contact the manufacturer when using this menu function.

5.3.8 时间

5.3.8 Time

“时间”菜单用于修改时钟。如图 5.24，时间设置完成后按“”确认键即修改成功，再按“”返回键返回主菜单。该菜单初始密码为“1008”。

The "Time" menu is used to modify the clock. As shown in Figure 5.24, press the "Enter" button after the time setting is completed, then press the "Esc" button to return to the main menu. The initial password of this menu is "1008".



图 5.24 时间设置

Figure 5.24 Time Setting

5.3.9 信息

5.3.9 Information

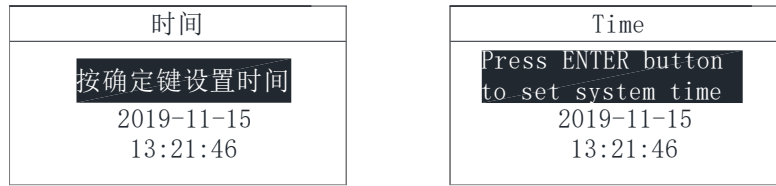
“信息”菜单可显示装置的基本信息包括装置名称、软件版本号、校验码、硬件配置生成时间、软件配置生成时间、保护逻辑图生成时间及逻辑图版本号等，如图 5.25 所示。

The "Information" menu can display the basic information of the device, including device name, software version number, check code, hardware configuration generation time, software configuration generation time, protection logic diagram generation time and logic diagram version number, etc., as shown in Figure5.25.



图 5.25 装置信息

Figure 5.25 Device information

第二章 技术说明

Chapter 2 Technical Description

1 保护功能原理

1 Protection Principle

1.1 弧光保护

1.1 Arc protection

弧光保护启动判据可选三种：弧光单判据，弧光和电流双判据，弧光和零序电压双判据。

There are three possible criteria for starting arc protection: single arc criterion, arc and current criterion, and arc and zero sequence voltage criterion.

(1) 弧光单判据

(1) Single criteria for arc criterion

当弧光强度大于其整定值，经延时，弧光保护动作。

When the arc intensity exceeds its set value, after a delay, the arc protection will activate.



图1.1 弧光单判据保护逻辑示意图

Figure 1.1 Schematic diagram of arc single criterion protection logic

(2) 弧光和电流双判据

(2) Dual criteria for arc and current

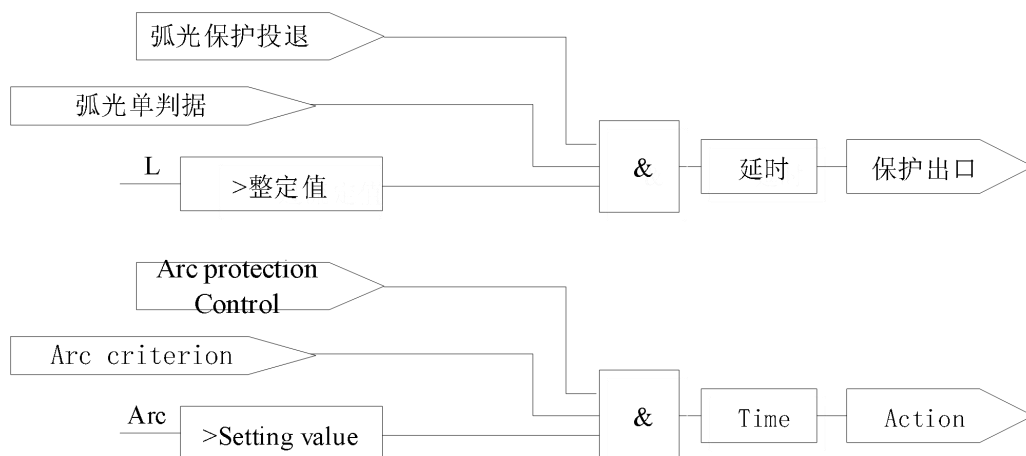
在发生弧光故障时，弧光光强会增大，电流值也会突变。弧光保护启动条件中加入电流判据，可有效排除外界光源干扰，提高可靠性。

When an arc fault occurs, the arc intensity will increase and the current value will suddenly change. Adding a current criterion to the starting conditions of arc protection can effectively eliminate interference from external light sources and

improve reliability.

当弧光光强大于其整定值,并且所关联的电流中任一电流值大于电流整定值时,经延时,弧光保护动作。

When the arc intensity is greater than its set value and any current value associated with it is greater than the current set value, the arc protection will activate after a delay.



图1.2 弧光和电流双判据保护逻辑示意图

Figure 1.2 Schematic diagram of dual criterion protection logic for arc and current

(3) 弧光和零序电压双判据

(3) Dual criteria for arc and zero sequence voltage

在不接地系统和消弧线圈接地系统,弧光保护启动条件中加入零序电压判据,可提高判别单相接地弧光故障的灵敏度。

Adding a zero sequence voltage criterion to the starting conditions of arc protection in ungrounded systems and arc suppression coil grounded systems can improve the sensitivity of identifying single-phase grounding arc faults.

当弧光光强大于其整定值,并且所关联的零序电压中任一电压值大于零序电压整定值时,经延时,弧光保护动作。

When the arc intensity is greater than its set value and any voltage value in

the associated zero sequence voltage is greater than the set value of the zero sequence voltage, after a delay, the arc protection will activate.



图1.3 弧光和零序电压双判据保护逻辑示意图

Figure 1.3 Schematic diagram of dual criterion protection logic for arc and zero sequence voltage

1.2 弧光监测及故障点定位功能

1.2 Arc monitoring and fault location function

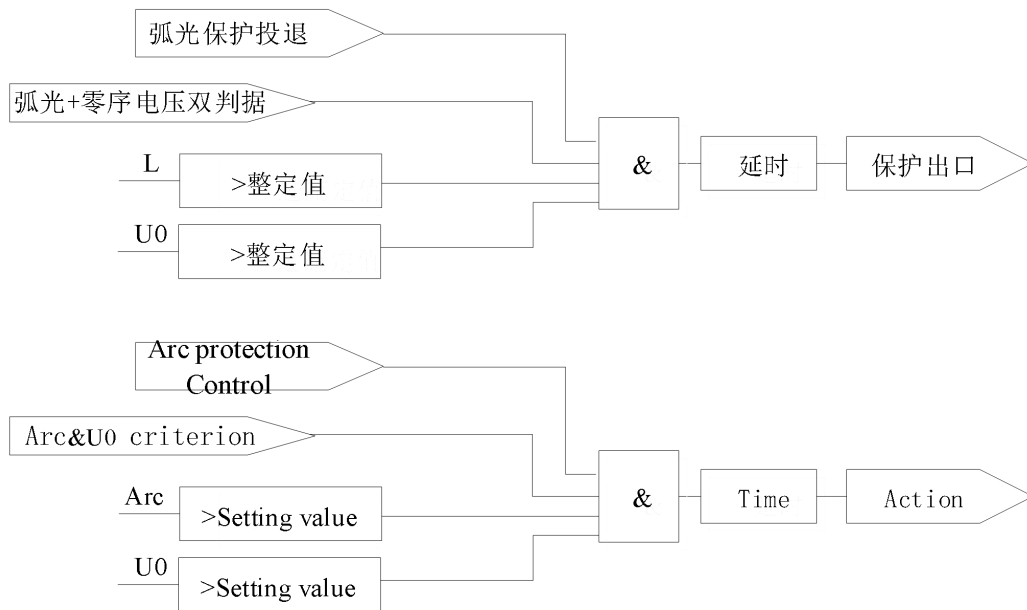
在投入“探头监测使能”软压板后，装置才能监测弧光传感器的实时光强值及传感器序号，并可通过“传感器光强值记录”控制字确定是否记录弧光传感器的光强值（当弧光光强大于整定值时）。“传感器光强值记录”控制字投入时，装置会记录每个弧光传感器的光强值；退出时，装置仍会实时监测弧光传感器的光强值，但不保存其光强值。

After the "sensor monitoring enable" soft pressing plate is put into operation, the device can monitor the real-time light intensity value and sensor serial number of the arc sensor, and can determine whether to record the light intensity value of the arc sensor through the "sensor light intensity value recording" control word (when the arc intensity is greater than the set value). When the "Sensor Light Intensity Record" control word is activated, the device will record the light intensity value of each arc sensor; When exiting, the device will still monitor the light intensity value of the arc sensor in real time, but will not save its light intensity value.

弧光故障触发弧光保护逻辑动作时，装置会结合弧光故障所在处的传感器序号和光强值，实现故障点定位功能。

When the arc fault triggers the arc protection logic action, the device will combine the sensor

serial number and light intensity value at the location of the arc fault to achieve the fault point positioning function.



图1.4 弧光传感器光强监测和弧光故障点定位逻辑示意图

Figure 1.4 Logic diagram of arc sensor intensity monitoring and arc fault location

1.3 弧光传感器及光纤链路监测

1.3 Arc sensor and fiber optic link monitoring

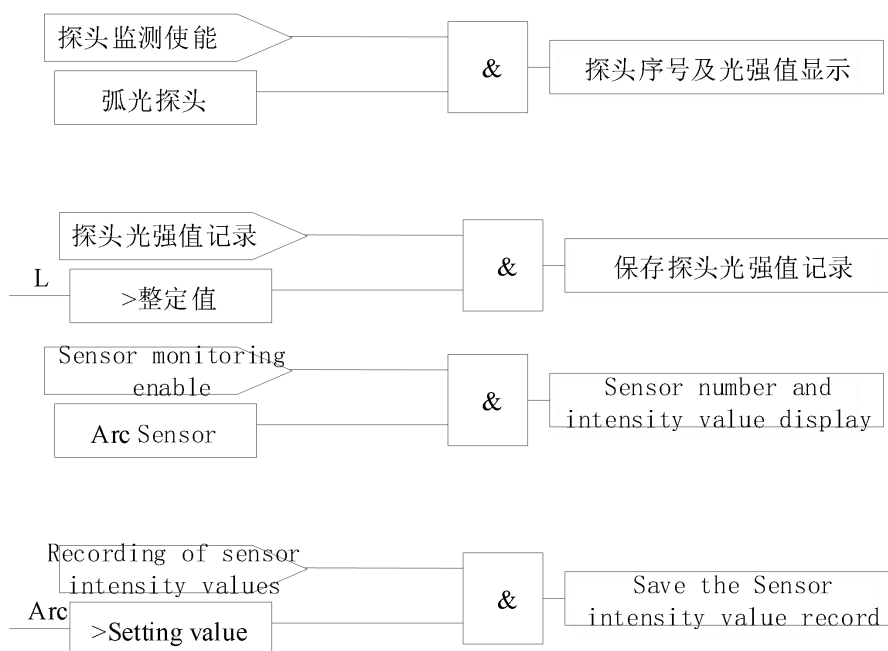
当投入“探头监测使能”软压板后，装置实时自检各个弧光传感器及光纤链路，当任一弧光传感器损坏或者其与弧光保护装置连接的光纤链路中断时，经延时，弧光链路自检告警。

When the "sensor monitoring enable" soft pressing plate is put into use, the device monitors the link situation of each arc sensor in real time. When any arc sensor is damaged or the fiber optic link connected to the arc protection device is interrupted, after a delay, the arc link self checks and alarms.

当弧光采集口不接传感器时，需退出相应的传感器监测使能软压板或者投入相应的闭锁传感器自检软压板，否则会报告该传感器链路自检异常。

When the arc acquisition port is not connected to a sensor, it is necessary to exit the corresponding sensor monitoring enable soft pressing plate or put in the corresponding locking sensor self check soft pressing plate, otherwise it will report an abnormal self check of the sensor link.

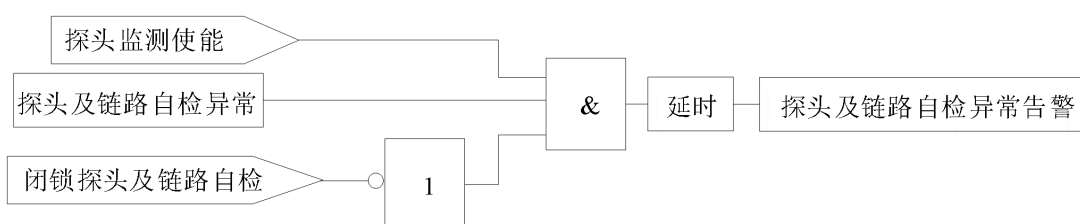



图 1.5 弧光传感器及光纤链路自检逻辑示意图

Figure 1.5 Schematic diagram of arc sensor and fiber optic link self-test logic

1.4 失灵保护

1.4 Failure protection

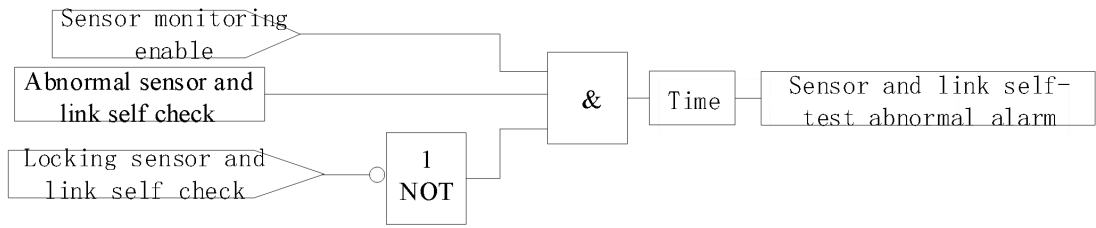
失灵保护逻辑可关联多组弧光保护和电流。当关联的弧光保护动作后，且关联的电流一直大于失灵定值，经延时，失灵保护动作。

The failure protection logic can be associated with multiple sets of arc protection and current. When the associated arc protection is activated and the associated current is consistently greater than the failure set value, the failure protection will activate after a delay.



图 1.6 失灵保护逻辑示意图

Figure 1.6 Schematic diagram of failure protection logic

1.5 CT 断线监测

1.5 CT monitoring

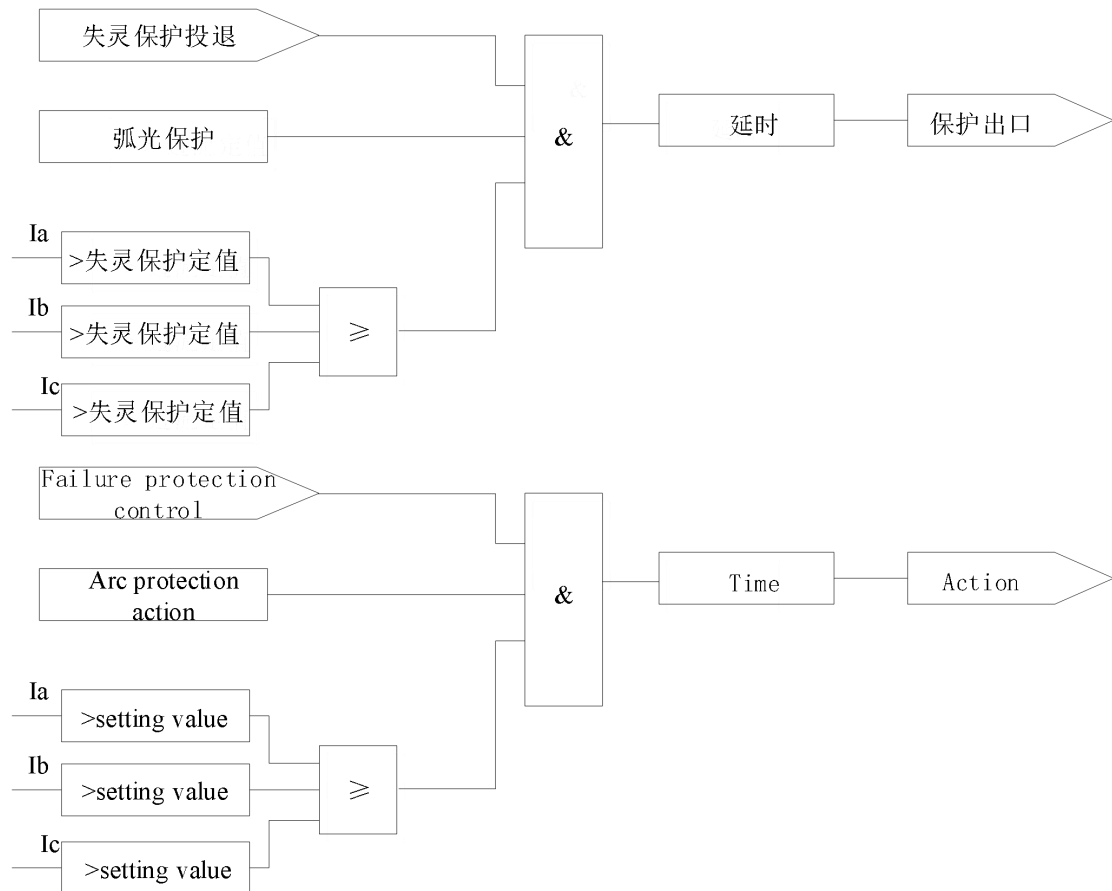
3CT 电流接线方式时，任一相或者两相电流断线，经延时，CT 断线告警动作；2CT 电流接线方式时，任一相电流断线，经延时，CT 断线告警动作。

When using the 3CT current connection method, if any phase or two phases of the current are disconnected, after a delay, the CT disconnection alarm will activate; When using the 2CT current wiring method, if any phase current is disconnected and delayed, the CT disconnection alarm will activate.



图 1.7 CT 断线告警逻辑示意图

Figure 1.7 Schematic diagram of CT disconnection alarm logic

1.6 非电量保护

1.6 Non-electric quantity protection

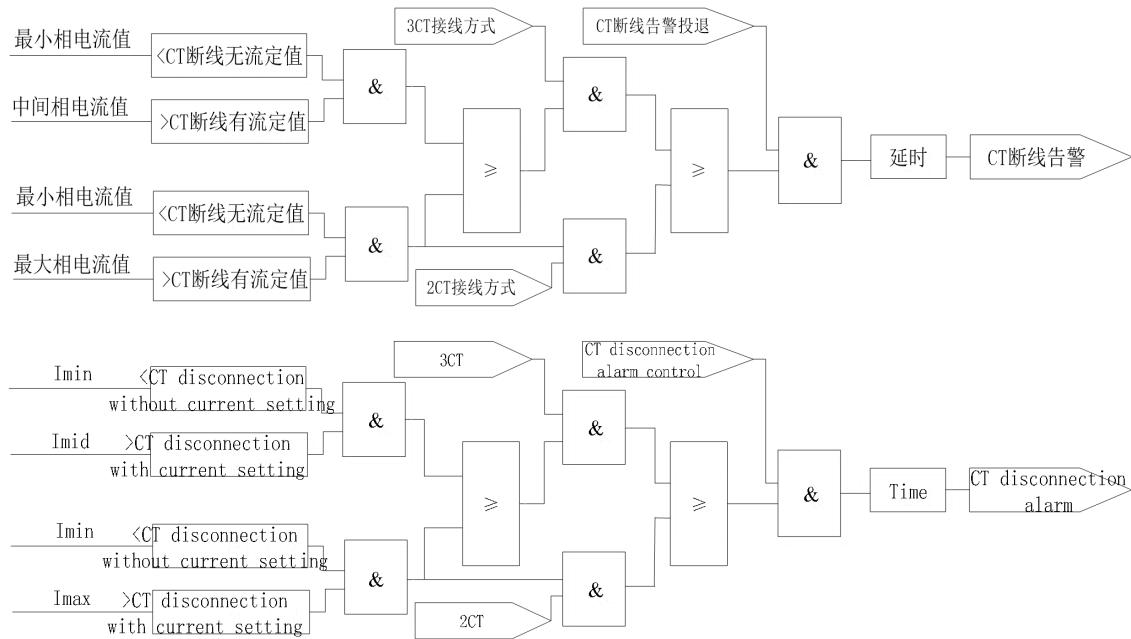
非电量保护投入，经延时，非电量保护动作。

Non-electric quantity protection is activated, and after a delay, the non electric quantity protection is activated.

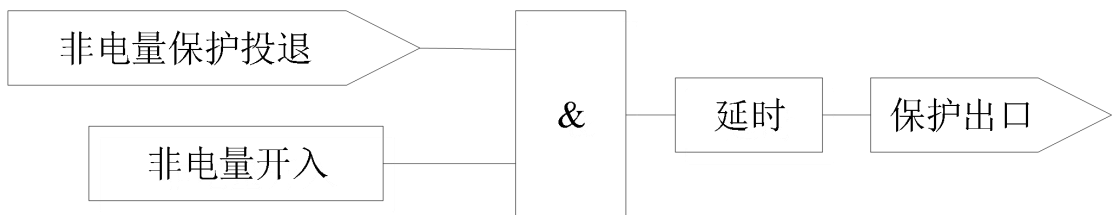



图 1.8 非电量保护逻辑示意图

Figure 1.8 Schematic diagram of non-electric protection logic

1.7 装置异常自检

1.7 Device Abnormal Self Test

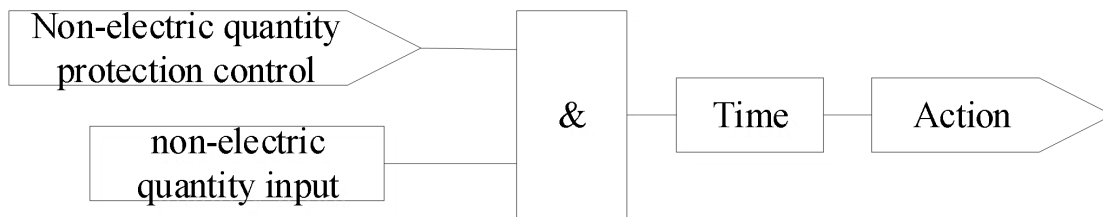
当装置失电或装置内部故障时，装置发出告警信号，同时装置的异常指示灯亮。

When the device loses power or has internal faults, the device sends an alarm signal and the abnormal indicator light of the device lights up.

1.8 检修状态闭锁

1.8 Maintenance status locking

外部开入（检修状态）可独立选择闭锁动作出口或通讯传输。若投入“检修状态闭锁出口”，则此时保护跳闸时，仅产生事件记录，装置出口不动作；若投入“检修状态闭锁通讯”，则此时无法通讯，但保护功能可正常动作。

External input (maintenance status) can independently select the locking action outlet or communication transmission. If the "maintenance status locking outlet" is activated, only event records will be generated when the protection trips, and the device outlet will not act; If "maintenance status locking communication" is activated, communication cannot be achieved at this time, but the protection function can operate normally.

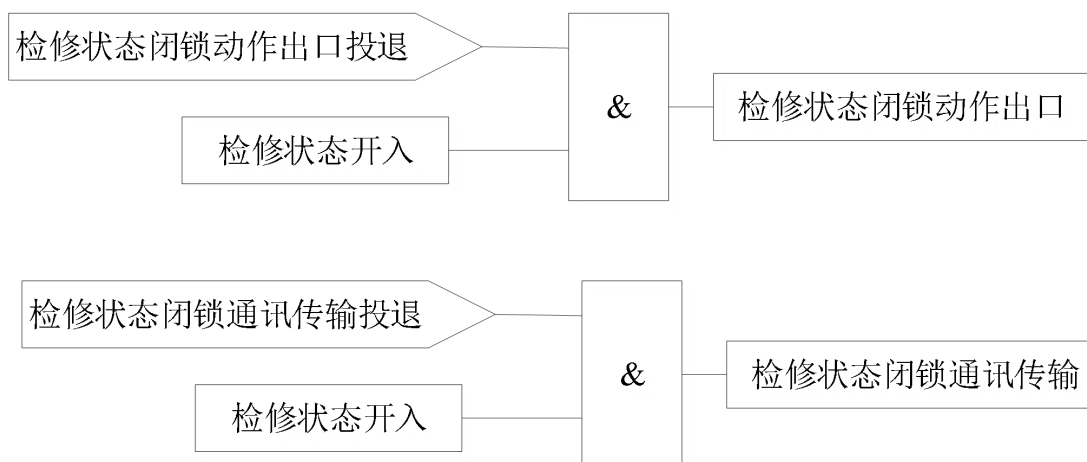



图 1.9 检修状态闭锁逻辑示意图

Figure 1.9 Maintenance Status Lockout Logic Diagram

2 参数表

2 Parameter Table

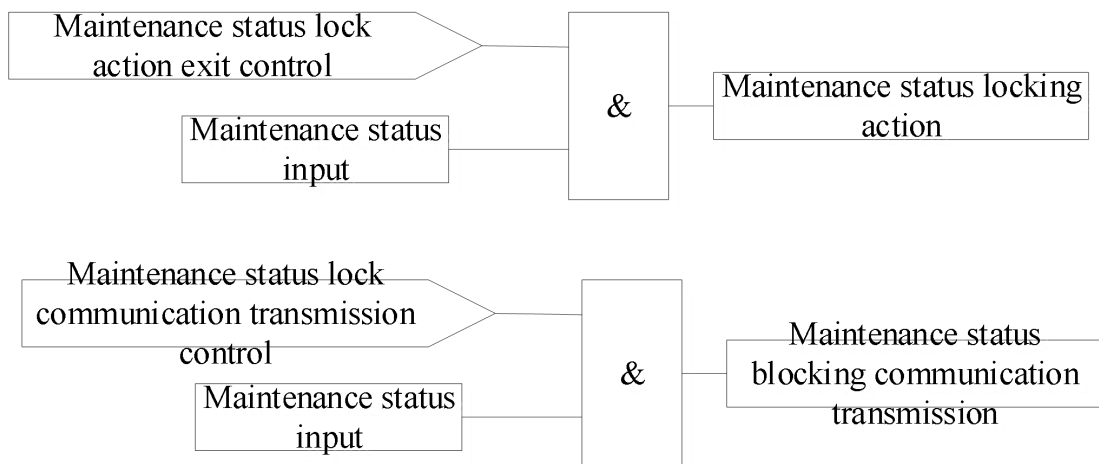
2.1 定值设置表

2.1 Fixed value setting table

表 2.1 ARB4 定值设置表
Table 2.1 ARB4 Setting Table

ARB4 定值设置 ARB4 constant value setting				
序号 No.	保护名称 Protection Function	定值名称 Value Name	默认值 Default	备注 Notice
1		电流接线方式 I Mode	3CT	3CT; 2CT
2		额定二次电流 (Ie)	5A	0.001A~200A
3		额定二次电压 (Ue)	100V	0.001V~400V
4	第 1 组 弧光保护 Group 1 Arc protection	第 1 组弧光保护投退 1K	退出 OFF	退出; 投入 OFF; ON
5		第 1 组弧光保护判据 1Crit	弧光与电流 (Arc & Current)	弧光 (Arc); 弧光与电流 (Arc & Current); 弧光与电压 (Arc & Voltage)
6		1 组弧光保护延时	0s	0s~9999.999s

		1Arc.T		
7		1 组电流定值 1I	1.2Ie	额定二次电流的倍数 (0.001~200) Ie
8		1 组电流通道映射 1IM	0000	4 路电流通道 (从左往右); 所在位为 1: 关联该电流。 4 current channels (from left to right); Position 1: Associate with the current.
9		1 组零序电压定值 1U0	0.4Ue	额定二次电压的倍数 (0.001~200) Ue
10		1 组电压通道映射 1UM	000	3 路电压通道; 所在位为 1: 关联该电压。 3 voltage channels; Position 1: Associate with the voltage.
11		1 组光强定值 1ARC	10klx	0klx~50klx
12		1 组传感器映射 1M1	000	第 1-3 号传感器 (从左往右); 所在位为 1: 关联该传感器。 Sensors 1-3 (from left to right); Position 1: Associate the sensor.
13		1 组出口映射 1DO	00000	5 路继电器出口 (从左往右); 所在位为 1: 关联该出口。 5 relay outlets (from left to right); Position 1: Associate with the DO.
14	第 2 组~第 3 组 ● 弧光保护 ● Group 2-3 ● Arc protection			
●				
●				
●				
33				

34	第 1 组 失灵保护 Group 1 Failure protection	1 组失灵保护投退 E.1SL	退出 OFF	退出；投入 OFF；ON
35		1 组失灵保护电流定值 1SI	2Ie	额定二次电流的倍数 (0.001~200) Ie
36		1 组失灵电流通道映射 1IM	0000	4 路电流通道（从左往右）；所在位为 1：关联该电流。 4 current channels (from left to right); Position 1: Associate with the current.
37		1 组失灵保护延时 1SL.T	0s	0s~9999.999s
38		1 组失灵保护出口映射 1SD	00000	5 路继电器出口（从左往右）；所在位为 1：关联该出口。 5 relay outlets (from left to right); Position 1: Associate with the DO.
39	弧光传感器 光强事件记录	传感器光强记录 E.Arc.E	退出 OFF	退出；投入 OFF；ON
40	arc sensor Light intensity event recording	传感器光强值 Arc.E.S	10klx	0klx~50klx
41	第 1 组 非电量保护 Group 1 non-electric quantity protection	非电量 1 投退 E.Non-el1	退出 OFF	退出；投入 OFF；ON
42		非电量 1 延时 Non-el1.T	1s	0s~9999.999s
43		非电量 1 出口映射 El.D	00000	5 路继电器出口（从左往右）；所在位为 1：关联该出口。 5 relay outlets (from left to right); Position 1: Associate with the DO.
44	第 2 组			
●	非电量保护			

●	Group 2			
●	non-electric			
46	quantity protection			
47	CT 断线告警 CT disconnection alarm	CT 断线投退 E.CTBr.A	退出 OFF	退出；投入 OFF；ON
48		CT 断线无流定值 CTBr.I.N	0.125A	0.04A~100A
49		CT 断线有流定值 CTBr.I.S	0.2A	0.04A~100A
50		CT 断线延时 CTBr.T	5s	0s~9999.999s
51		CT 断线出口映射 CTBr.D	00000	5 路继电器出口（从左往右）；所在位为 1：关联该出口。 5 relay outlets (from left to right); Position 1: Associate with the DO.
52		检修状态闭锁 Maintenance status lock	检修闭锁通讯投退 E.M.BC	退出 OFF
53	检修闭锁出口投退 E.M.BE		退出 OFF	退出；投入 OFF；ON
54		链路异常出口映射 link.D	00000	5 路继电器出口（从左往右）；所在位为 1：关联该出口。 5 relay outlets (from left to right); Position 1: Associate with the DO.
55		装置失电出口映射 PpwerD	00000	5 路继电器出口（从左往右）；所在位为 1：关联该出口。 5 relay outlets (from left to right); Position 1: Associate with the DO.
56		保护动作信号出口映射	00000	5 路继电器出口（从左往

		S2		右)；所在位为 1: 关联该出口。 5 relay outlets (from left to right); Position 1: Associate with the DO.
57		断路器动作延时 Cir.Br.T	20ms	20ms~10000ms
58		过量返回系数 Excess R.C	0.95	0.001~1.000
59		欠量返回系数 Under R.C	1.05	1.000~2.000

2.2 软压板设置表

2.2 Soft pressing plate setting table

装置可独立控制每个弧光采集端口。当弧光传感器光纤接入弧光采集端口时，需“投入”相应传感器的监测使能软压板。只有“投入”监测使能软压板的弧光传感器，其光强值才能被监测，并且其对应的传感器及光纤实时自检功能才会开启。当弧光采集端口没有接入光纤时，须“退出”对应的监测使能软压板，否则装置会报告该传感器链路自检异常。

The device can independently control each arc acquisition port. When the optical fiber of the arc sensor is connected to the arc acquisition port, the corresponding sensor's monitoring and enabling soft pressing plate needs to be "put into operation". Only the arc sensor that enables the soft pressing plate to be monitored can its light intensity value be monitored, and its corresponding sensor and fiber real-time self check function will be activated. When the arc collection port is not connected to the fiber optic cable, the corresponding monitoring enable soft pressing plate must be "exited", otherwise the device will report an abnormal self check of the sensor link.

表 2.2 ARB4 软压板设置表

Table 2.2 ARB4 Soft Pressing Plate Setting Table

ARB4 软压板 ARB4 soft pressing plate		
序号 No.	软压板名称 Soft pressing plate	备注 Notice
1	传感器 1 监测使能 ARC1.E	接入光纤的，须投入相应的传感器使能；没接入光纤的，须退出相应的传感器使能。
2	传感器 2 监测使能 ARC2.E	切记：不能多投，也不能少投！ For fiber optic connections, corresponding sensors must be installed to

3	传感器 3 监测使能 ARC3.E	enable them;If there is no fiber optic connection, the corresponding sensor must be disabled.
4	闭锁传感器 1 自检 L1.B	退出：传感器及链路自检
5	闭锁传感器 2 自检 L2.B	投入：传感器及链路不自检 Exit: Sensor and Link Self Test
6	闭锁传感器 3 自检 L3.B	Input: Sensor and link not self checking

3 背板端子定义和二次原理图

3 Backboard terminal definition and secondary schematic diagram

3.1 背板端子定义图

3.1 Backboard terminal definition diagram

ARB4 系列弧光保护装置背板端子如图 3.1 所示，包括交流量接线、开入开出接线、通讯接线和辅助电源接线等。

The back panel terminals of the ARB4 series arc protection device are shown in Figure 3.1, including AC wiring, input/output wiring, communication wiring, and auxiliary power wiring.

X2.11—X2.18 为 4 路保护电流接入端子，X2.5—X2.10 为 3 路零序电压接入端子。

X2.11-X2.18 are 4 protection current connection terminals, X2.5-X2.10 are 3 zero sequence voltage connection terminals.

X1.14—X1.22 为 8 路开入量接线端子（X1.14 为开入公共端）。所有开入允许接交直流电压 AC/DC220V, AC/DC110V, DC48V 或 DC24V。同组的开入必须有相同的极性。

X1.14-X1.22 are 8-way input terminal blocks (X1.14 is the input common terminal). All inputs are allowed to connect AC/DC220V, AC/DC110V, DC48V or DC24V. The same group of inputs must have the same polarity.

X1.1—X1.10 为开出量接线端子，共有 5 路电磁式继电器无极性接点，均为常开触点。5 路开关量输出的具体定义可以通过装置的“出口映射”菜单界面查看。

X1.1-X1.10 are the output wiring terminals, with a total of 5 non-polar contacts for electromagnetic relays, all of which are normally open contacts. The specific definition of 5 sets of switch outputs can be viewed through the "Exit Mapping" menu interface of the device.

X1.12—X1.13 为复合通信端子，可配置为 RS485 通信端子（支持 IEC60870-5-103 和 Modbus RTU 通讯规约），也可配置为 IRIG-B 对时端子，二选一。

X1.12-X1.13 are composite communication terminals that can be configured as RS485 communication terminals (supporting IEC60870-5-103 and Modbus RTU communication protocols) or as IRIG-B timing terminals, with either option.

X2.1—X2.2 为辅助电源端子，X2.4 为辅助电源保护地，必须可靠连接大地。

X2.1-X2.2 are the auxiliary power supply terminals, and X2.4 is the auxiliary power supply protection ground, which must be reliably connected to the ground.

X8.1-X8.3 为弧光传感器的光纤接入端子。

X8.1-X8.3 are the fiber optic connection terminals for the arc sensor.



图 3.1 ARB4 背板端子定义图

Figure 3.1 ARB4 Backplane Diagram

3.2 二次原理图

3.2 schematic diagram

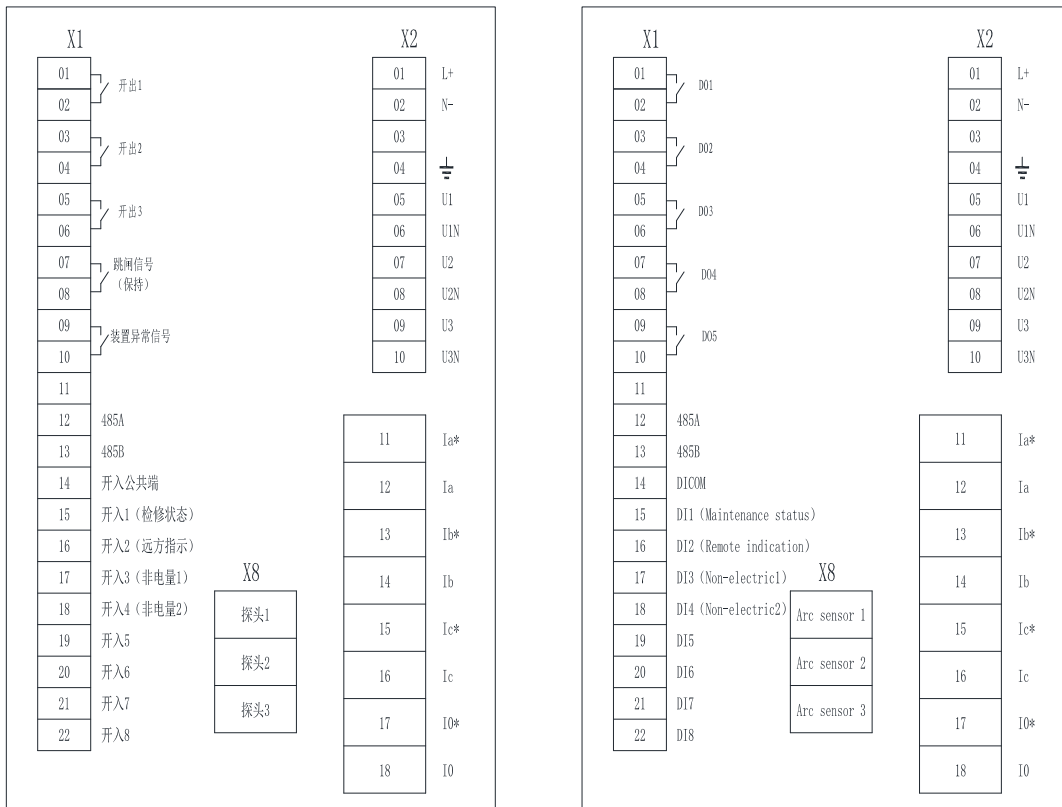
ARB4 系列弧光保护装置的二次原理图，如下。

The secondary schematic diagram of the ARB4 series arc protection device is as follows.



图 3.2 电流、电压回路二次原理图

Figure 3.2 Secondary schematic diagram of current and voltage circuits

注：电压回路为选配，请根据项目实际情况选择是否接入电压回路。

Note: The voltage circuit is optional. Please choose whether to connect the voltage circuit according to the actual situation of the project.

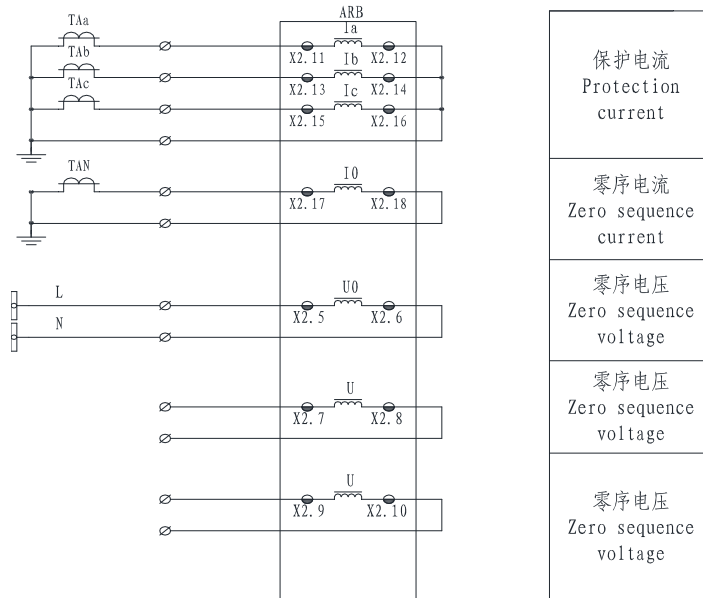

图 3.3 装置电源、开入量回路二次原理图

Figure 3.3 Secondary schematic diagram of device power supply and input circuit

注：保护装置为共地系统，运行前须可靠接地！

Note: The protective device is a common ground system and must be reliably grounded before operation.

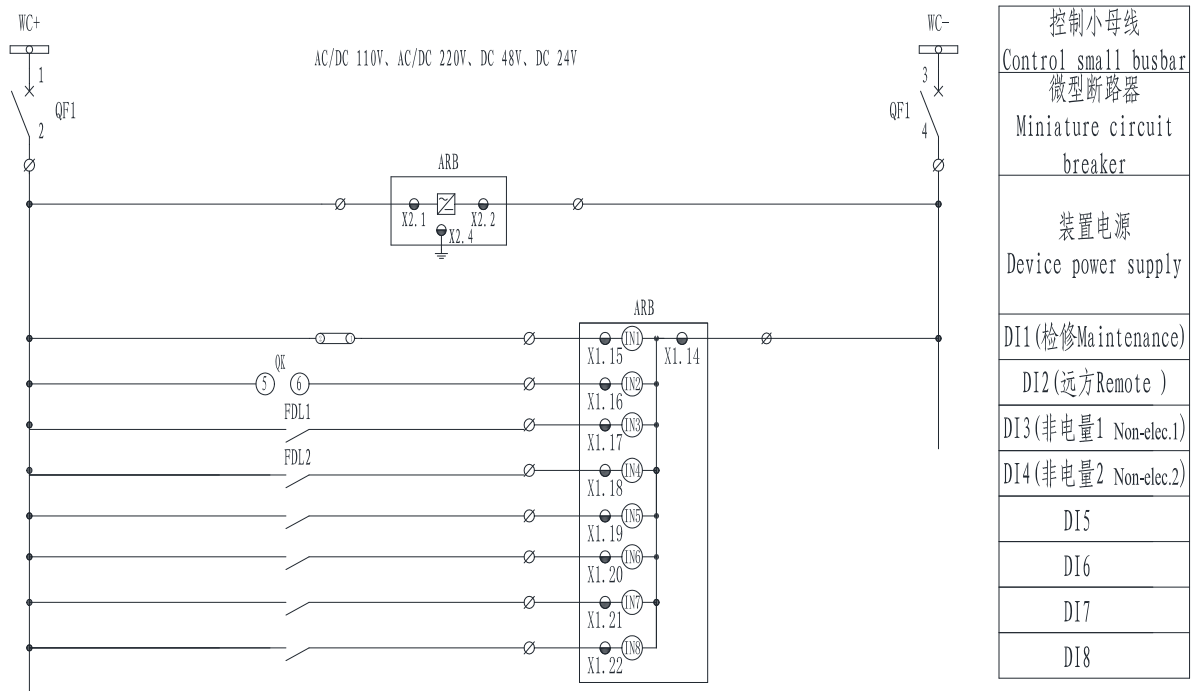

图 3.4 控制回路二次原理图

Figure 3.4 Secondary schematic diagram of control circuit

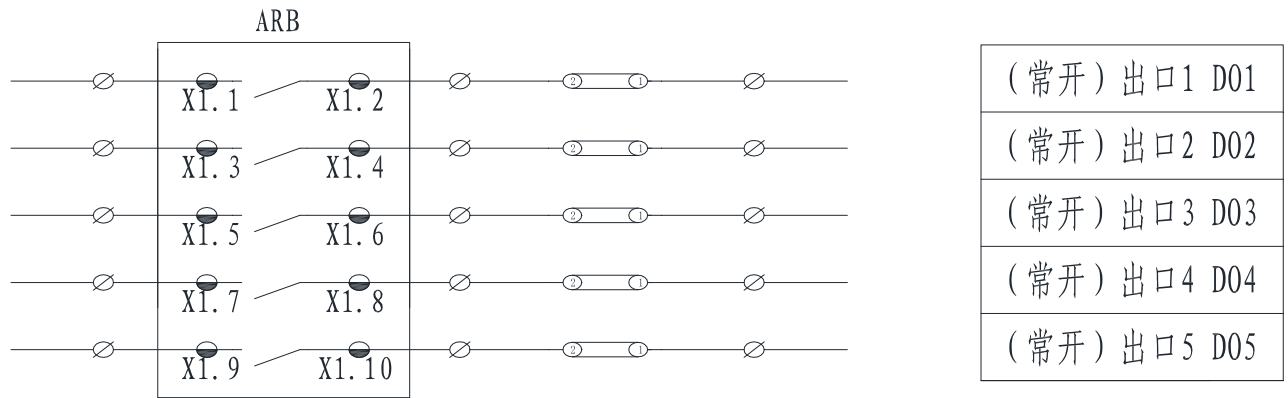

图 3.5 通信接口示意图

Figure 3.5 Communication Interface Diagram

注：X1.12-X1.13 为复合通信端口，可配置为 RS485 通信端子，也可配置为 IRIG-B 对时端子，二选一。

Note: X1.12-X1.13 is a composite communication port that can be configured as an RS485 communication terminal or an IRIG-B timing terminal, with either option.

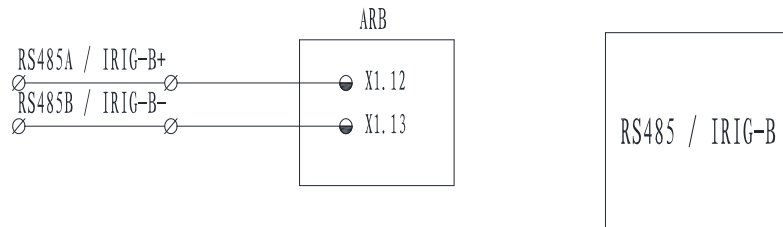

图 3.6 弧光采集接口光纤连接示意图

Figure 3.6 Schematic diagram of POF connection for arc acquisition interface

Chapter 3 Typical Configuration and Application

1 电缆室弧光保护典型配置

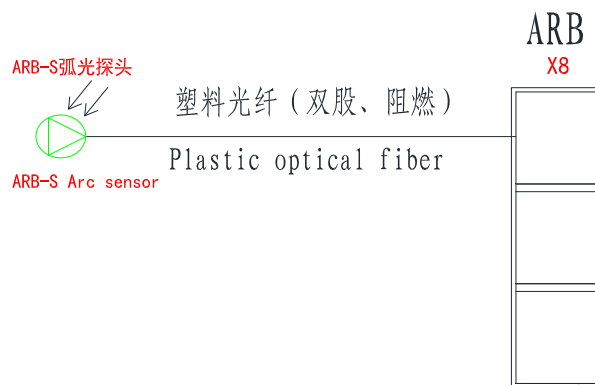
1 Typical configuration of arc protection in cable room



图 1.1 ARB 弧光保护典型配置图

Figure 1.1 Typical configuration diagram of ARB arc protection

电缆室弧光保护，即在每面馈线柜分别配置 1 台 ARB4 弧光保护装置，每面馈线柜的电缆室安装 1 个 ARB-S 弧光传感器。

Cable room arc protection, which means that one ARB4 arc protection device is installed in each feeder cabinet, and one ARB-S arc sensor is installed in the cable room of each feeder cabinet.

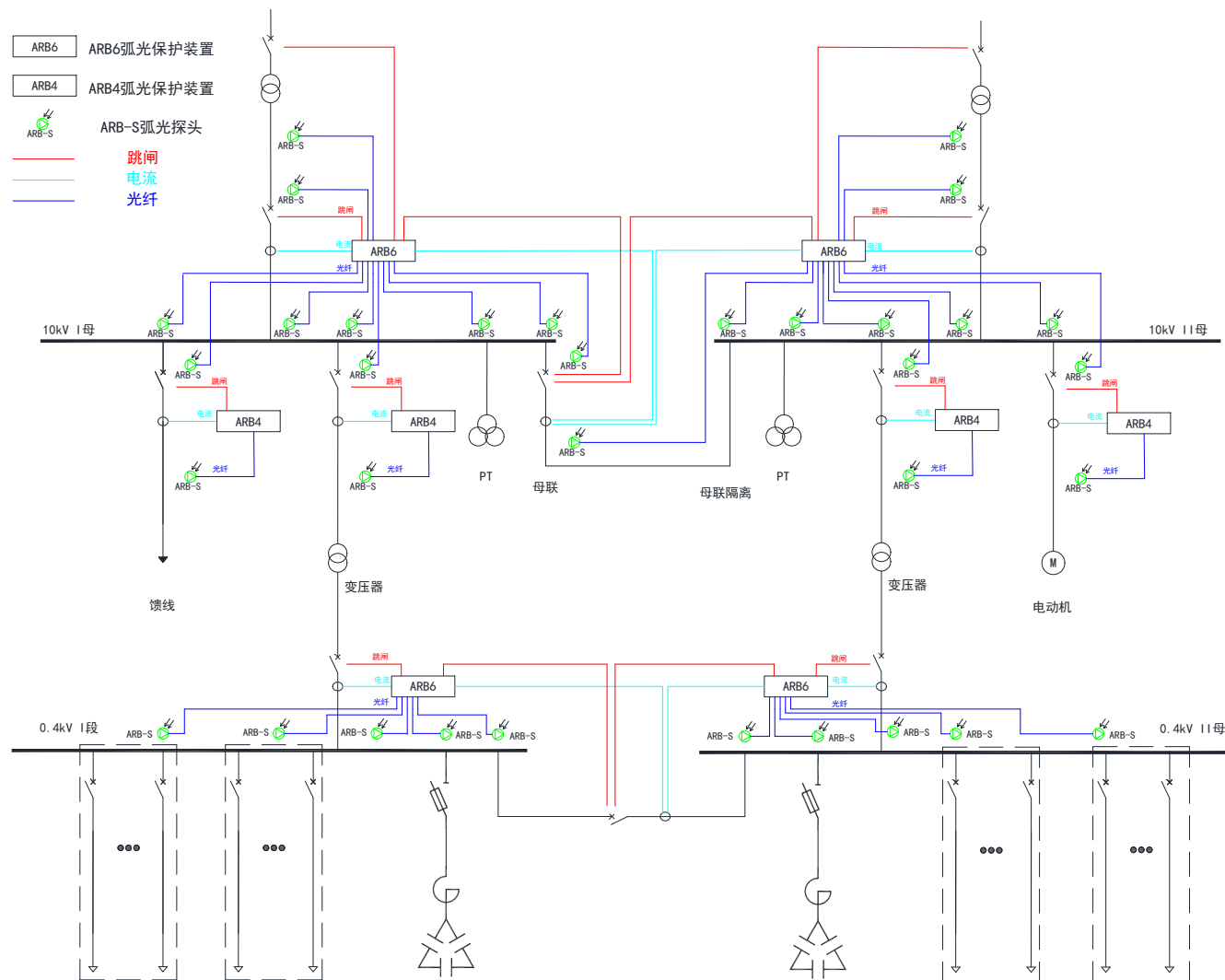
ARB4 弧光装置监测馈线柜电缆室弧光，并采集馈线柜电流，弧光（电缆室）+电流（馈线柜）双判据，动作跳闸馈线柜断路器。

The ARB4 arc light device monitors the arc light in the cable room of the feeder cabinet and collects the current of the feeder cabinet. The arc light (cable room)+current (feeder cabinet) dual criteria act to trip the circuit breaker of the feeder cabinet.

2 典型接线及参数设置

2. Typical wiring and parameter settings

ARB4 弧光保护装置的 X2.11-X2.16 端子采集三相电流，X8.1 端子采集 1 路弧光信号，X1.1-X1.2 端子为动作继电器 DO1 跳闸本段馈线柜断路器。

The X2.11-X2.16 terminals of the ARB4 arc protection device collect three-phase current, the X8.1 terminal collects one arc signal, and the X1.1-X1.2 terminals are the action relay DO1 to trip the circuit breaker of this section of the feeder cabinet.

相关参数设置如下。

The relevant parameter settings are as follows.

ARB4 定值设置 ARB4 constant value setting				
序号 No.	保护名称 Protection Function	定值名称 Value Name	整定值 Setting	备注 Notice
4	第 1 组 弧光保护 Group 1 Arc protection	第 1 组弧光保护投退 1K	投入 ON	
5		第 1 组弧光保护判据 1Crit	弧光与电流 (Arc & Current)	
6		1 组弧光保护延时 1Arc.T	0s	电力部门出具，或者默认 Issued by the power department, or default
7		1 组电流定值 1I	1.2Ie	电力部门出具，或者默认 Issued by the power department, or default
8		1 组电流通道映射 1IM	1110	关联第 1-3 路电流通道 Associate the 1st to 3rd current channels
9		1 组零序电压定值 1U0	0.4Ue	电力部门出具，或者默认 Issued by the power department, or default
10		1 组电压通道映射	000	不涉及，不需修改

		1UM		No involvement, no modification required
11		1 组光强定值 1ARC	10klx	电力部门出具, 或者默认 Issued by the power department, or default
12		1 组传感器映射 1M1	100	关联第 1 号传感器 Associate sensors 1
13		1 组出口映射 1DO	10000	DO1 跳闸 DO1 trip

ARB4 软压板 ARB4 soft pressing plate			
序号 No.	软压板名称 Soft pressing plate name	整定值 Setting	备注 Notice
1	传感器 1 监测使能 Sensors 1 monitoring enable	投入 ON	

3 弧光保护功能调试

3 Arc protection function debugging

在调试过程中, 当保护跳闸时, 装置面板上“跳闸”指示灯点亮, 对应继电器动作出口, 液晶上显示相应事件记录信息; 当保护告警时, 装置面板上“告警”指示灯点亮, 对应继电器动作出口, 液晶上显示相应事件记录信息。

During the debugging process, when the protection trips, the "trip" indicator light on the device panel lights up, corresponding to the relay action outlet, and the corresponding event record information is displayed on the LCD; When a protection alarm occurs, the "alarm" indicator light on the device panel lights up, corresponding to the relay action outlet, and the corresponding event record information is displayed on the LCD.

依据实际项目一次图和开关柜布局图, 合理配置弧光保护装置和弧光传感器, 并参考上节“保护逻辑及参数设置”给出的参数设置方法, 给装置正确设置参数后, 方可进行调试。

Based on the actual project diagram and switchgear layout, configure the arc protection device and arc sensor reasonably, and refer to the parameter setting method provided in the previous section "Protection Logic and Parameter Setting". After setting the parameters correctly for the device, debugging can be carried out.

(1) 弧光单判据

(1) Arc single criterion

1) 使用手持式光标仪或者其他光照强度高的光源模拟发生弧光，给弧光传感器打光。

1) Simulate the occurrence of arc using a handheld cursor or other high intensity light source to illuminate the arc sensor.

2) 在光纤未连接的情况下，可给装置背板的弧光采集板端子打光。

2) When the fiber optic cable is not connected, the arc acquisition board terminals on the device backplane can be illuminated.

(2) 弧光与电流双判据

2) Arc and current dual criteria

1) 依据二次图，给装置施加电流。

1) Apply current to the device according to the quadratic diagram.

2) 使用手持式光标仪或者其他光照强度高的光源模拟发生弧光，给弧光传感器打光。

2) Simulate the occurrence of arc using a handheld cursor or other high intensity light source to illuminate the arc sensor.

3) 在光纤未连接的情况下，可给装置背板的弧光采集板端子打光。

3) When the fiber optic cable is not connected, the arc acquisition board terminals on the device backplane can be illuminated.

(3) 弧光与电压双判据

(3) arc and voltage dual criteria

1) 依据二次图，给装置施加电压。

1) Apply voltage to the device according to the quadratic diagram.

2) 使用手持式光标仪或者其他光照强度高的光源模拟发生弧光，给弧光传感器打光。

2) Simulate the occurrence of arc using a handheld cursor or other high intensity light source to illuminate the arc sensor.

3) 在光纤未连接的情况下，可给装置背板的弧光采集板端子打光。

3) When the fiber optic cable is not connected, the arc acquisition board terminals on the device backplane can be illuminated.

4 维护及常见问题

4 Maintenance and common problems

装置为免维护产品，只要安装运行环境满足要求，正常运行期间不需要日常及定期保养维护。但要留意因长期轻微震动引起的螺丝松动情况。

The device is a maintenance free product, and as long as the installation and operation environment meets the requirements, there is no need for daily or regular maintenance during normal operation. But pay attention to the loosening of screws

caused by long-term slight vibration.

下表是在装置使用过程中可能会遇到的问题及相应处理建议。

The following table shows the problems that may be encountered during the use of the device and corresponding handling suggestions.

表 4.1 问题及相应处理建议

Table 4.1 Problems and corresponding handling suggestions

问题 Problems	可能原因 Possible causes	处理建议 Processing suggestions
光纤链路异常 Arc sensor link abnormality	1、光纤与装置或传感器未接触好 1. Fiber optic not in good contact with device or sensor 2、光纤未研磨光滑 2. Fiber optic not ground smooth 3、装置背板的传感器采集口未接入传感器（光纤），但投入了该传感器监测使能软压板 3. The sensor acquisition port on the device backplane is not connected to a sensor (fiber optic), but the sensor is used to monitor and enable the soft pressing plate	1、正确插接光纤 1. Correctly plugging in optical fibers 2、重新制作接头并研磨光纤 2. Remake the connector and grind the fiber optic cable 3、退出未连接光纤的传感器监测使能软压板 3. Exit the sensor monitoring enable soft pressing plate without connecting the fiber optic cable
继电器不跳闸 The DO without trip	1、该功能未投入 1. The Enale is exit 2、保护启动条件未达到 2. Protection activation conditions not met 3、出口映射配置错误 3. Export mapping configuration error	1、在定值里投入相应保护 1. Input corresponding protection in the fixed value 2、检查调试方法 2. Check and debug methods 3、在调试菜单进行相应出口配置 3. Configure the corresponding exit in the debugging menu
无通讯 No communication	1、接线极性接反 1. Reverse polarity of wiring 2、通讯参数或规约不一致 2. Inconsistent communication parameters or protocols 3、通讯电缆断线 3. Communication cable disconnection 4、装置地址设置错误 4. Device address setting error	1、调换极性接线 1. Swapping polarity wiring 2、重新设置通讯参数或规约 2. Reset communication parameters or protocols 3、维修或更换通讯电缆 3. Repair or replace communication cables 4、在通讯菜单内设置装置地址 4. Set device address in the communication menu
指示灯显示异常	1、装置为初始化状态	1、请按一次复归键

Abnormal indicator light display	1. Device in initialization state 2、指示灯颜色配置错误 2. Indicator light color configuration error	1. Please press the reset button once 2、在调试菜单配置指示灯颜色 2. Configure indicator light colors in the debugging menu
遥信无显示 Remote communication without display	对应遥信没采到开入信号 Corresponding remote signaling did not receive input signal	检查装置端子和公共端之间电压 Check the voltage between the device terminals and the common terminal

总部：安科瑞电气股份有限公司

Headquarter: Acrel Co., LTD.

地址：上海市嘉定区育绿路 253 号

Address: No.253 Yulv Road Jiading District, Shanghai, China

电话：0086-21-69158338 0086-21-69156052 0086-21-59156392 0086-21-69156971

TEL.: 0086-21-69158338 0086-21-69156052 0086-21-59156392 0086-21-69156971

传真：0086-21-69158303

Fax: 0086-21-69158303

网址：www.acrel-electric.com

Web-site: www.acrel-electric.com

邮箱：ACREL008@vip.163.com

Email: ACREL008@vip.163.com

邮编：201801

Postcode: 201801

生产基地：江苏安科瑞电器制造有限公司

Manufacturer: Jiangsu Acrel Electrical Manufacturing Co., LTD.

地址：江苏省江阴市南闸街道东盟工业园区东盟路 5 号

Address : No.5 Dongmeng Road,Dongmeng industrial Park, Nanzha Street,Jiangyin

City,Jiangsu Province,China

电话：0086-510-86179966

TEL: 0086-510-86179966

传真：0086-510-86179975

Fax: 0086-510-86179975

网址：www.jsacrel.com

Web-site: www.jsacrel.com

邮箱：sales@email.acrel.cn

Email: sales@email.acrel.cn

邮编：214405

Postcode: 214405