

651



ARB6 弧光保护装置

ARB6 Arc Flash Protection Relay

安装使用说明书 v1.1

Operational Manual v1.1

安科瑞电气股份有限公司
Acrel CO.,LTD

申 明

DECLARATION

版权所有，未经本公司之书面许可，此手册中任何段落，章节内容均不得被摘抄、拷贝或以任何形式复制、传播，否则一切后果由违者自负。

本公司保留一切法律权利。

All rights reserved. No part of this publication may be reproduced, stored in a retrieval system, or transmitted in any form by any means, electronic, mechanical photocopying, recording, or otherwise without prior permission of our company. The violator will bear the dependent legal responsibility.

We reserve all the rights.

本公司保留对本手册所描述之产品规格进行修改的权利，恕不另行通知。

订货前，请垂询当地代理商以获悉本产品的最新规格。

We reserve all the rights to revise product specification without notice. Please consult local agent to get the latest information of our products specification.

目 录

CONTENTS

第一章 使用说明.....	1
Chapter 1 Brief introduction.....	1
1 装置介绍.....	1
1 Device Introduction.....	1
1.1 概述.....	1
1.1 Information.....	1
1.2 特点.....	2
1.2 Feature.....	2
1.3 装置选型表.....	4
1.3 Device Selection Table.....	4
1.4 装置功能对照表.....	6
1.4 Selection guide.....	6
2 技术参数.....	7
2 Technical Parameters.....	7
2.1 额定参数.....	7
2.1 Rated parameters.....	7
2.2 主要技术性能.....	9
2.2 Basic mechanical design feature.....	9
2.3 正常工作环境条件.....	10
2.3 Normal working conditions.....	10
2.4 绝缘性能.....	10
2.4 Insulating property.....	10
2.5 电磁兼容性能.....	10
2.5 Electromagnetic compatibility performance.....	10
2.6 阻燃性能.....	11
2.6 Flame retardant performance.....	11
3 开孔尺寸和安装位置.....	11
3.1 装置开孔尺寸和安装位置.....	12
3.1 Device opening size and installation position.....	12
3.2 传感器开孔尺寸和安装位置.....	13
3.2 Sensor hole size and installation position.....	13
3.3 注意事项.....	19
3.3 Note.....	19
4 装置操作说明.....	20
4 Operational Manual.....	20
4.1 前面板说明.....	20

4.1 Surface.....	20
4.2 按键说明.....	21
4.2 Key instructions.....	21
4.3 菜单说明.....	22
4.3 Menu instructions.....	22
第二章 技术说明.....	43
Chapter 2 Technical Description.....	43
1 保护功能原理.....	43
1 Protection Principle.....	43
1.1 弧光保护.....	43
1.1 Arc protection.....	43
1.2 弧光监测及故障点定位功能.....	45
1.2 Arc monitoring and fault location function.....	45
1.3 弧光传感器及光纤链路监测.....	46
1.3 Arc sensor and fiber optic link monitoring.....	46
1.4 失灵保护.....	47
1.4 Failure protection.....	47
1.5 CT 断线监测.....	48
1.5 CT monitoring.....	48
1.6 非电量保护.....	49
1.6 Non-electric quantity protection.....	49
1.7 装置异常自检.....	49
1.7 Device Abnormal Self Test.....	49
1.8 检修状态闭锁.....	49
1.8 Maintenance status locking.....	49
2 参数表.....	50
2 Parameter Table.....	50
2.1 定值设置表.....	50
2.1 Fixed value setting table.....	50
2.2 软压板设置表.....	55
2.2 Soft pressing plate setting table.....	55
3 背板端子定义和二次原理图.....	56
3 Backboard terminal definition and secondary schematic diagram.....	56
3.1 背板端子定义图.....	56
3.1 Backboard terminal definition diagram.....	56
3.2 二次原理图.....	63
3.2 schematic diagram.....	63
第三章 典型配置及应用.....	67
Chapter 3 Typical Configuration and Application.....	67
1 母线弧光保护典型配置.....	67
1 Typical configuration of busbar arc protection.....	67
2 保护逻辑及参数设置.....	68
2. Protection logic and parameter settings.....	68
3 弧光保护功能调试.....	76

3 Arc protection function debugging.....	76
4 维护及常见问题.....	77
4 Maintenance and common problems.....	77

第一章 使用说明

Chapter 1 Brief introduction

1 装置介绍

1 Device Introduction

1.1 概述

1.1 Information

ARB6 系列弧光保护装置硬件采用模块化（包括电源模块、CPU 模块、弧光采集模块、模拟量采集模块、开入开出模块、通讯模块、人机接口模块等）设计，集保护、测量、监视、控制、通讯、故障录波、事件记录等多种功能于一体，实时监测弧光信号、保护电流或电压信号，实现 0.4kV~35kV 中低压配电系统的电弧光保护功能。装置软件配以专门的保护算法，抗干扰性能强，可靠性高，保护实现方式灵活，能与 Acrel-2000 电力监控系统配套使用，为电力系统的安全可靠运行提供保障。

The hardware of the ARB6 series arc protection device adopts a modular design (including power module, CPU module, arc acquisition module, analog acquisition module, input/output module, communication module, human-machine interface module, etc.), integrating multiple functions such as protection, measurement, monitoring, control, communication, fault recording, event recording, etc., to monitor arc signals, protection current or voltage signals in real time, Implement arc protection function for 0.4kV~35kV medium and low voltage distribution systems. The device software is equipped with specialized protection algorithms, which have strong anti-interference performance, high reliability, flexible protection implementation methods, and can be used in conjunction with the Acrel-2000 power monitoring system, providing guarantees for the safe and reliable operation of the power system.

ARB6 系列弧光保护装置操作便捷、资源丰富、稳定可靠、维护方便，广泛应用于电力、水利、交通、工业、矿产、新能源、舰船、建筑楼宇等行业。

The ARB6 series arc protection device is easy to operate, abundant in resources, stable and reliable, and easy to maintain. It is widely used in industries such as electricity, water conservancy, transportation, industry, minerals, new energy, ships, and construction buildings.

1.2 特点

1.2 Feature

➤ 高性能的硬件平台：

High-performance hardware platform

装置采用主频为 550MHz 的处理器，16 位同步采样 A/D，每周波 48 点高速采样、实时并行计算；配置 512K 字节 Flash、(192+4) K 字节 Sram、外置 4M 字节 NorFlash、外置 512K 字节 Sram，硬件资源充足，可靠性高。

The device adopts a processor with a main frequency of 550MHz, 16 bit synchronous sampling A/D, high-speed sampling of 48 points per week, and real-time parallel computing; Configure 512K bytes of Flash, (192+4) K bytes of Sram, external 4M bytes of NorFlash, and external 512K bytes of Sram, with sufficient hardware resources and high reliability.

➤ 完善的保护功能：

Mature and perfect protection function

适用于 35kV 及以下电压等级的电力系统电弧光保护和自动控制功能。装置可实现弧光保护、弧光故障点定位、弧光传感器及光纤链路实时自检、失灵保护、CT 断线监测、非电量保护、装置异常告警、故障录波等功能。

Suitable for arc protection and automatic control functions in power systems with voltage levels of 35kV and below. The device can achieve functions such as arc protection, arc fault point positioning, real-time self inspection of arc probes and fiber optic links, failure protection, CT disconnection monitoring, non electric quantity protection, device abnormal alarm, fault recording, etc.

➤ 丰富的接口资源：

Rich interface resources

12 路交流电流通道和 3 路交流电压通道，测量 4 组三相电流和 3 组零序电压；

22 路有源开关量输入通道（可选）+1 路装置电源失电输入通道；

16 路独立无源开关量输出通道（14 路常开接点、2 路常闭接点），其中 4 路快速继电器出口；

2 路 RS485 串行通讯接口，支持 IEC60870-5-103、Modbus 规约；

3 路以太网接口（可选），支持 TCP IEC60870-5-103、TCP Modbus 规约；

1 路 GPS 对时接口，支持 IRIG-B 对时方式（RS485 接口）；

1 个 USB 接口，可通过 U 盘升级装置程序，也可导出装置的定值、故障录波数据，方便故障分析。

12 AC current channels and 3 AC voltage channels, measuring 4 sets of three-phase currents and 3 sets of zero sequence voltages;

22 active switch input channels (optional)+1 device power loss input channel;

16 independent passive switch output channels (14 normally open contacts and 2 normally closed contacts), including 4 fast relay outlets;

2 RS485 serial communication interfaces, supporting IEC60870-5-103 and Modbus protocols;

3-way Ethernet interface (optional), supporting TCP IEC60870-5-103 and TCP Modbus protocol;

1 GPS timing interface, supporting IRIG-B timing method (RS485 interface);

1 USB interface, which can be used to upgrade device programs through a USB drive, and can also export device settings and fault recording data, facilitating fault analysis.

➤ 人性化

Humanization

装置采用全汉化大屏幕液晶显示，人机界面清晰易懂。

The device adopts a fully Chinese large screen LCD display, with a clear and easy to understand human-machine interface.

灵活、舒适的按钮设计，菜单式操作简单、便捷。

Flexible and comfortable button design, simple and convenient menu style operation.

保护功能的出口可通过跳闸矩阵进行设置，方便用户选择要动作的继电器。

The outlet of the protection function can be set through the trip matrix, making it convenient for users to choose the relay to operate.

➤ 透明化:

Transparency

实时记录交流量、弧光量、开入量、开出量和所有保护模块的状态。

Real time recording of traffic flow, arc, input, output, and the status of all protection modules.

装置记录内部各元件动作行为、动作时间等信息，并可以查看事件记录（不少于 200 条）、系统记录（不少于 500 条）、操作日志（不少于 2000 条）。

The device records the action behavior and time of various internal components, and can view event records (no less than 200), system records (no less than 500), and operation logs (no less than 2000).

装置记录故障录波信息，可在装置上直接查看波形，也可导出录波文件。16 条故障录波信息，每条录波可触发 4 段录波（每个采样点录波至少包含 46 个模拟量、39 个开关量波形），每段录波可录故障前 2 个周波、故障后 10 个周波波形，共计 15.36s。

The device records fault waveform information, which can be directly viewed on the device or exported as a waveform file. 16 fault recording information, each recording can trigger 4 segments of recording (each sampling point recording should contain at least 46 analog signals

and 39 switch signal waveforms). Each segment of recording can record the first 2 cycles of the fault and the last 10 cycles of the fault, for a total of 15.36 seconds.

➤ **高可靠性设计:**

High reliability design

装置采用全图形编程技术设计每个保护功能，以提高程序的可靠性及正确性。

The device adopts full graphic programming technology to design each protection function, in order to improve the reliability and correctness of the program.

软硬件具有持续完善的自检功能，抗干扰性能好，装置通过多项电磁兼容检测认证，电快速瞬变脉冲群、静电放电、浪涌抗干扰性能均达到 IV 级标准。

The software and hardware have continuously improved self checking functions, good anti-interference performance, and the device has passed multiple electromagnetic compatibility testing certifications. The electrical fast transient pulse group, electrostatic discharge, and surge anti-interference performance all meet the IV level standard.

1.3 装置选型表

1.3 Device Selection Table

1.3.1 弧光保护装置选型表

1.3.1 Selection Table of Arc Protection Device

ARB	-	-	-	-	以太网接口: 一路	1
					三路	3
					装置电源: AC/DC 110V	1
					AC/DC 220V	2
					DC 48V、DC 24V	3
					电流输入: 1A	1
					5A	5
					装置代号: 能采集6路弧光探头信号	A6
					能采集12路弧光探头信号	A12
					能采集18路弧光探头信号	A18
					能采集24路弧光探头信号	A24
					能采集30路弧光探头信号	A30
产品系列号					6	
产品名称		弧光保护装置				

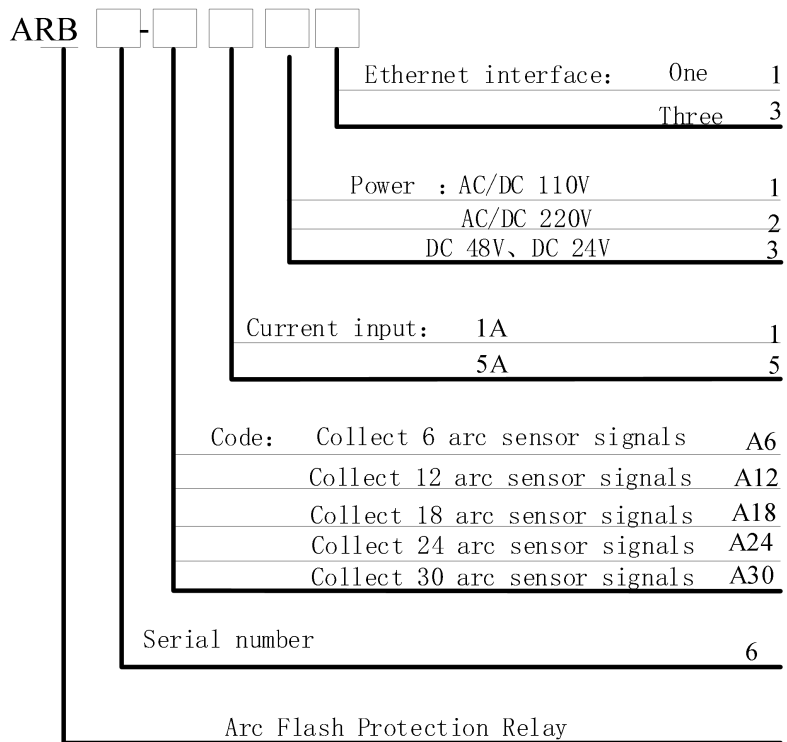

1.3.2 弧光传感器选型表

1.3.2 Selection Table for Arc Sensors

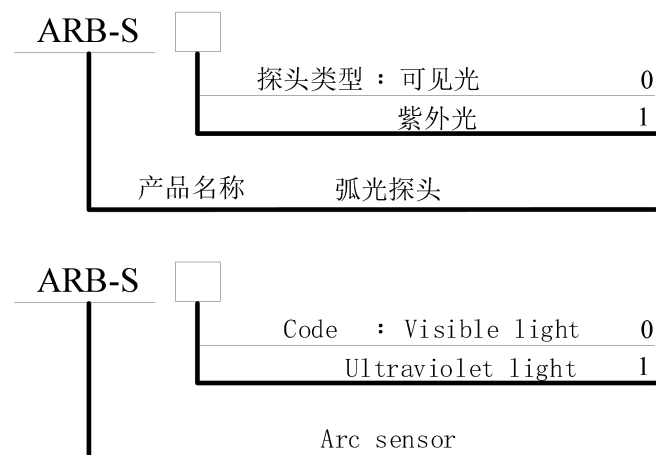

1.4 装置功能对照表

1.4 Selection guide

主要功能 Function		型号 Model	ARB6-A6	ARB6-A12	ARB6-A18	ARB6-A24	ARB6-A30
硬件资源 Hardware	弧光传感器信号采集 Arc sensor signal acquisition		6	12	18	24	30
	电流采集 Current collection		4组3相电流, 共12路电流通道 4 sets of 3-phase currents, a total of 12 current channels				
	电压采集 Voltage acquisition		3路零序电压, 共3路电压通道 3 zero sequence voltages, a total of 3 voltage channels				
	开入量采集 Digital Input		5	22	5	22	5
	继电器输出 Digital Output		14路常开出口 (其中4路高速出口) 和2路常闭出口 14 normally open exits (including 4 High speed relay outlet) and 2 normally closed exits				
	2路RS485接口 2 485 interface		√				
	1路以太网接口 1 Ethernet interface		√				
	3路以太网接口 3 Ethernet interface		■				
	GPS对时 GPS timing interface		√				
	USB接口 USB interface		√				
保护功能 Function	弧光保护 Arc protection	弧光单判据 Arc criterion	√				
		弧光与电流双判据 Arc&Current criterion	√				
		弧光与零序电压双判据 Arc&Voltage criterion	√				
	弧光监测及故障点定位 Arc monitoring and fault location		√				
	弧光传感器及光纤链路实时自检 Real time self inspection of arc sensors and fiber optic links		√				

	失灵保护 failure protection	√
	CT 断线监测 CT disconnection monitoring	√
	非电量保护 non-electricity protection	√
	装置异常告警 Device abnormal alarm	√
	检修状态闭锁 Maintenance status lock	√
	故障录波 Fault recording	√
通信规约 Protocol	Modbus	√
	IEC101	√
	IEC103	√
	IRIG-B	√
	LoopBack	√

注：√表示具备此功能，■表示可选功能。

Note: √ indicates having this function, and ■ indicates optional function.

2 技术参数

2 Technical Parameters

2.1 额定参数

2.1 Rated parameters

2.1.1 工作电源

2.1.1 Power supply

额定电压：AC/DC 220V、AC/DC 110V、DC 48V 或 DC 24V

范 围：额定电压×（1±20%）

功 耗：≤15 VA

Power supply: AC/DC220V, AC/DC110V, DC48V ,DC24

Range: Power supply ×（1±20%）

Maximum power consumption: ≤15VA

2.1.2 输入激励电压

2.1.2 Rated voltage

额 定 值：线电压 AC 100V 或相电压 $100/\sqrt{3}$ V

测量范围：0.1V~120V

准确度：±1%

功率损耗：每相功率损耗不大于 0.5VA

过载能力：1.4 倍额定电压，连续工作；

2 倍热过载，允许 10s。

Rated voltage: AC 100V or $100/\sqrt{3}$ V

Range: 0.1~120V

Accuracy: ±1%

Power consumption: ≤0.5VA (single phase)

Overload capacity: 1.4 times rated voltage for continuous work;

2 times for 10 seconds.

2.1.3 输入激励电流（保护电流）

2.1.3 Rated current (Protection current)

额定值：AC 5A 或 1A

测量范围：0.04In~20In

功率损耗：每相功率损耗不大于 0.5VA

过载能力：2 倍额定电流，连续工作；

40 倍额定电流，允许 1s。

Rated current: AC 5A/1A

Range: 0.04In~20In

Power consumption: ≤0.5VA (single phase)

Overload capacity: 2 times rated current for continuous work;

40 times for 1 second.

2.1.4 频率

2.1.4 Frequency

额定频率：50Hz 或 60Hz

频率范围：40~70Hz

准确度：±0.1Hz

Rated frequency: 50Hz or 60Hz

Range: 40~70Hz

Accuracy: ±0.1Hz

2.1.5 开关量输入

2.1.5 Digital Input

额定电压: AC/DC 220V、AC/DC 110V、DC 48V 或 DC 24V

电压范围: 额定电压 $\times (1 \pm 20\%)$

功率消耗: 每通道功率消耗 $\leq 1W$ (DC220V)

Rated Voltage: AC/DC220V, AC/DC110V, DC48V, DC24V

Voltage range: Rated Voltage $\times (1 \pm 20\%)$

Power consumption: $\leq 1W$ (DC220V)

2.1.6 开关量输出

2.1.6 Digital Output

机械寿命: ≥ 10000 次

接通容量: $\geq 1000W$, L/R = 40ms

导通电流: 连续 $\geq 5A$, 短时 (200ms) $\geq 30A$

断开容量: $\geq 30W$, L/R = 40ms

Mechanical life: ≥ 10000

Switching capacity: $\geq 1000W$, L/R = 40ms

On current: continuous $\geq 5A$, short time (200ms) $\geq 30A$

Interrupting capacity: $\geq 30W$, L/R = 40ms

2.2 主要技术性能

2.2 Basic mechanical design feature

电压元件: 整定值容许误差应不大于 $\pm 3\%$; 过压返回系数 0.95, 欠压返回系数 1.05。

Voltage element: The allowable error of setting value should not be greater than $\pm 3\%$; the return coefficient of overpressure should be 0.95, and the return coefficient of underpressure should be 1.05.

电流元件: 整定值容许误差应不大于 $\pm 3\%$; 过流返回系数 0.95, 欠流返回系数 1.05。

Current element: The allowable error of setting value should not be greater than $\pm 3\%$; the return coefficient of overcurrent should be 0.95, and the return coefficient of undercurrent should be 1.05.

频率元件: 整定值容许误差应不大于 ± 0.02 Hz。

Frequency element: The allowable error of setting value should not be greater than ± 0.02 Hz.

比较元件: 过量比较元件返回系数为 0.95, 欠量比较元件返回系数 1.05。

Comparison element: Return coefficient is 0.95 or 1.05.

时间元件: 延时时间 2s 内, 误差 $\leq 40ms$; 延时时间大于 2s, 误差 $\leq (2\%)$ 整定值 $\pm 40ms$ 。

Timing element: Delay time within 2 seconds error is $\leq 40ms$, delay time is more than 2 seconds, error ($\leq 2\%$) tuning value $\pm 40ms$.

弧光保护动作时间：弧光单判据 $\leq 3.8\text{ms}$ （2倍弧光动作门槛值，电磁继电器输出）；
弧光电流双判据 $\leq 7.8\text{ms}$ （2倍弧光动作门槛值和2倍电流定值，电磁继电器输出）。

Arc protection action time: Arc single criterion $\leq 3.8\text{ms}$ (twice the arc action threshold value, electromagnetic relay output);

Arc current dual criterion $\leq 7.8\text{ms}$ (twice the arc action threshold value and twice the current constant value, electromagnetic relay output).

2.3 正常工作环境条件

2.3 Normal working conditions

环境温度： $-10^{\circ}\text{C} \sim +55^{\circ}\text{C}$ 。

Ambient temperature: $-10^{\circ}\text{C} \sim +55^{\circ}\text{C}$.

装置的贮存、运输允许的环境温度为 $-25^{\circ}\text{C} \sim +70^{\circ}\text{C}$ 。

Device storage, transport allows the ambient temperature is $-25^{\circ}\text{C} \sim +70^{\circ}\text{C}$.

相对湿度：5%~95%（产品内部不凝露，不结冰）。

Relative humidity: 5%~95% (The product does not condensation and freeze inside).

海拔高度： $\leq 2500\text{m}$ 。

Altitude: $\leq 2500\text{m}$.

防护等级：IP40（面板、侧板及上下底板）。

Protection level: IP40 (front panel, left and right side panels, and upper and lower bottom plates).

2.4 绝缘性能

2.4 Insulating property

绝缘电阻： $>100\text{M}\Omega$ ，500Vdc

Insulation resistance: $>100\text{M}\Omega$ ，500Vdc

介质强度：回路和地之间，独立回路之间：工频耐压 2kV

Dielectric strength: Between the circuit and the ground, between the independent loop: power frequency voltage withstand 2kV

冲击电压： $\pm 5\text{kV}(1.2/50 \mu\text{s}, 0.5\text{J})$

Impulse voltage: $\pm 5\text{kV}(1.2/50 \mu\text{s}, 0.5\text{J})$

2.5 电磁兼容性能

2.5 Electromagnetic compatibility performance

	试验项目	要求
--	------	----

	Test item	Requirement
1	辐射发射限值检验 Radiation emission limit test	满足 IEC 60255-26:2013 规定 Meet the requirements of IEC 60255-26:2013
2	传导发射限值检验 Conduction emission limit test	满足 IEC 60255-26:2013 规定 Meet the requirements of IEC 60255-26:2013
3	射频电磁场辐射抗扰度 Radio-frequency electromagnetic field radiation immunity	满足 IEC 60255-26:2013 规定, 严酷等级 10V/m Meet the requirements of IEC 60255-26:2013, severity is 10V/m.
4	静电放电抗扰度 Electrostatic discharge immunity	满足 IEC 60255-26:2013 规定, 严酷等级为 IV 级 Meet the requirements of IEC 60255-26:2013, severity is IV level.
5	射频场感应传导骚扰抗扰度 Disturbance immunity of RF Field Induction conduction	满足 IEC 60255-26:2013 规定, 严酷等级骚扰电平 10V Meet the requirements of IEC 60255-26:2013, severe grade disturbance level is 10V.
6	电快速瞬变脉冲群抗扰度 Immunity of electric fast transient pulse group	满足 IEC 60255-26:2013 规定, 严酷等级为 A 级 Meet the requirements of IEC 60255-26:2013, severity is A level.
7	慢速阻尼振荡波抗扰度 Slow-damped oscillation wave immunity	满足 IEC 60255-26:2013 规定, 共模 2.5kV, 差模 1kV Meet the requirements of IEC 60255-26:2013, the common mode is 2.5 and the difference module is 1.
8	浪涌抗扰度 Surge immunity	满足 IEC 60255-26:2013 规定, 严酷等级为 IV 级 Meet the requirements of IEC 60255-26:2013, severity is IV level.
9	交流和直流电压暂降中断影响试验 Effect test of AC and DC voltage sag interruption	满足 IEC 60255-26:2013 规定 Meet the requirements of IEC 60255-26:2013
10	工频磁场抗扰度 Power frequency magnetic field immunity	满足 IEC 60255-26:2013 规定, 严酷等级为 IV 级 Meet the requirements of IEC 60255-26:2013, severity is IV level.

2.6 阻燃性能

2.6 Flame retardant performance

试验项目 Test item	要求 Requirement
水平燃烧 Horizontal Burning	满足 GB/T 5169.16-2017 规定, 严酷等级 HB 级 Meet the requirements of GB/T 5169.16-2017, with a severity level of HB

3 开孔尺寸和安装位置

3 Hole size and installation position

ARB6 系列弧光保护方案，主要由 ARB6 弧光保护装置、ARB-S 弧光传感器及塑料光纤（双股、阻燃）组成。

The ARB6 series arc protection scheme mainly consists of ARB6 arc protection device, ARB-S arc sensor, and plastic optical fiber (double stranded, flame retardant).



图 3.1 弧光保护装置、弧光传感器及光纤实物图

Figure 3.1 Actual diagram of arc protection device, arc sensor, and optical fiber

3.1 装置开孔尺寸和安装位置

3.1 Device opening size and installation position

3.1.1 装置外形图和开孔尺寸

3.1.1 Device Outline Drawing and Opening Dimensions



图 3.2 弧光保护装置外形及开孔尺寸图

Figure 3.2 Outline and Opening Dimensions of arc Protection Device

注：开孔尺寸以毫米（mm）为单位。

Note: The size of the opening is in millimeters (mm).

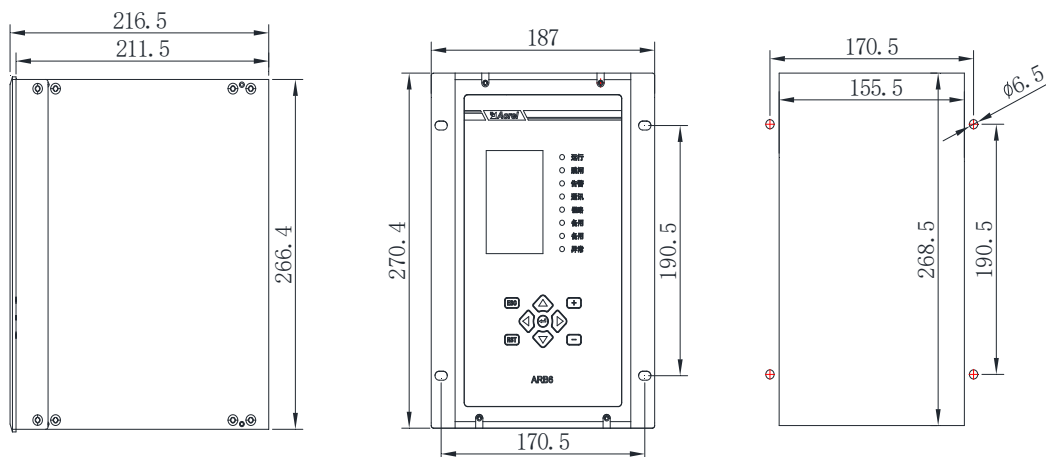
3.1.2 装置安装位置

3.1.2 Installation position of the device

弧光保护装置安装时需考虑开关柜安装空间，与保护范围内电源进线回路的 TA 回路连接、保护跳闸回路连接，原则上采用就近安装方式，避免 TA 采集回路、跳闸回路连线过长，一般安装于主变压器中、低压侧进线柜或 TV 柜柜门上，建议采用面板开孔安装。

When installing the arc protection device, the installation space of the switchgear should be considered, and it should be connected to the TA circuit of the power supply incoming circuit and the protection tripping circuit within the protection range. In principle, it should be installed nearby to avoid the TA acquisition circuit and tripping circuit wiring being too long. It is generally installed on the main transformer, low-voltage side incoming cabinet or TV cabinet door, and it is recommended to use panel opening installation.



图 3.3 弧光保护装置安装示意图

Figure 3.3 Installation diagram of arc protection device

3.2 传感器开孔尺寸和安装位置

3.2 Sensor hole size and installation position

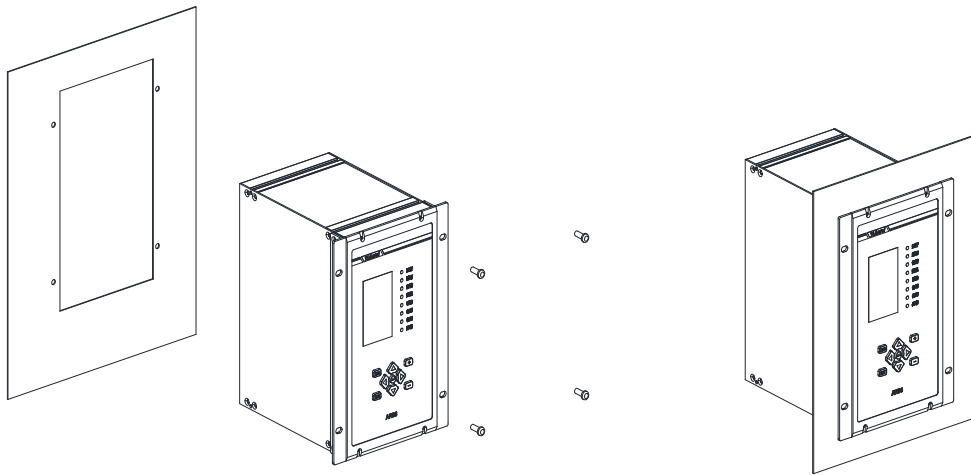
3.2.1 传感器外形图和开孔尺寸

3.2.1 Sensor Outline Drawing and Opening Dimensions

弧光传感器配套卡扣支架使用，卡扣支架需要开孔安装。卡扣支架的开孔尺寸为 20mm（直径）。

The arc sensor is equipped with a buckle bracket, which needs to be installed with holes. The opening size of the buckle bracket is 20mm (diameter).



图 3.4 弧光传感器外形及开孔尺寸图

Figure 3.4 Appearance and Opening Dimensions of Arc Sensor

3.2.2 传感器安装位置

3.2.2 Sensor installation position

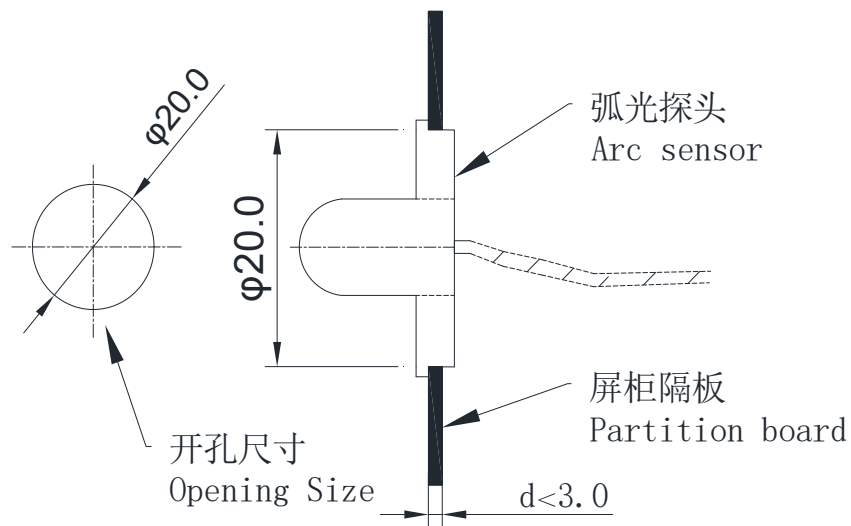
弧光传感器的检测范围是一个角度为 180° ，半径 0.5m 的扇形区域，所以选择传感器

安装点时应充分考虑该要素，避免出现检测盲区。

The detection range of the arc sensor is a fan-shaped area with an angle of 180° and a radius of 0.5m. Therefore, when selecting the sensor installation point, this element should be fully considered to avoid blind spots in detection.

弧光传感器安装应遵循以下原则：

The installation of arc sensors should follow the following principles:

弧光传感器建议安装地点包括（但不限于）母线室、断路器室、电缆室。

The recommended installation locations for arc sensors include (but are not limited to) busbar rooms, circuit breaker rooms, and cable rooms.

在开关柜有断路器的情况下，弧光传感器建议安装容易产生电弧的位置（如：在母线触头连接处、上或下隔离开关（2处）触头处、电流互感器触头处、电缆接头处）。在开关柜无断路器的情况下，弧光传感器建议安装在母线触头连接处、上和下隔离开关触头处（1处）、电缆接头处。

In the case of a circuit breaker in the switchgear, it is recommended to install the arc sensor in a location that is prone to arc generation (such as at the connection of the busbar contact, the contact of the upper or lower isolation switch (2 positions), the contact of the current transformer, and the cable joint). In the absence of a circuit breaker in the switchgear, it is recommended to install the arc sensor at the busbar contact connection, upper and lower isolation switch contacts (1 point), and cable joints.

封闭式母线桥架在桥架两端需要安装弧光传感器。若考虑实现开关柜的整体保护，可以在开关柜的断路器室和电缆室各安装1个弧光传感器。

A closed busbar bridge requires the installation of arc sensors at both ends of the bridge. If considering the overall protection of the switchgear, one arc sensor can be installed in each of the circuit breaker room and cable room of the switchgear.

弧光传感器安装示例如下。

The installation example of the arc sensor is as follows.

1) 母线室

1) Busbar compartment

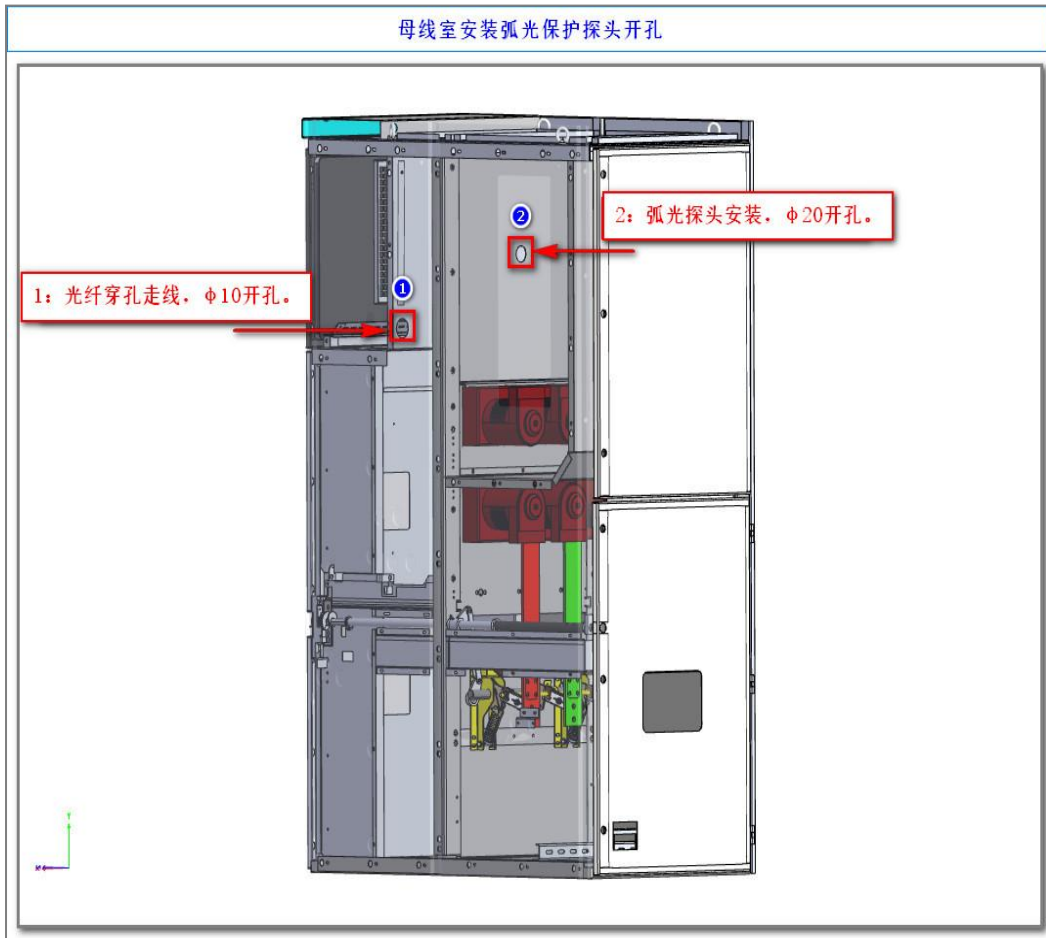

也可如下图安装, B 点是母线室散热窗附近, 在这个点位开孔安装弧光传感器, 塑料光纤在柜顶引至 C 点进入仪表室, 再到达 D 点附近, 经开关柜二次电缆穿线孔汇集至弧光保护装置。

It can also be installed as shown in the figure below. Point B is near the heat dissipation window of the busbar room. At this point, an arc sensor is installed by opening a hole. The plastic fiber optic cable is led from the top of the cabinet to point C and enters the instrument room, then reaches point D and converges to the arc protection device through the secondary cable threading hole of the switchgear.

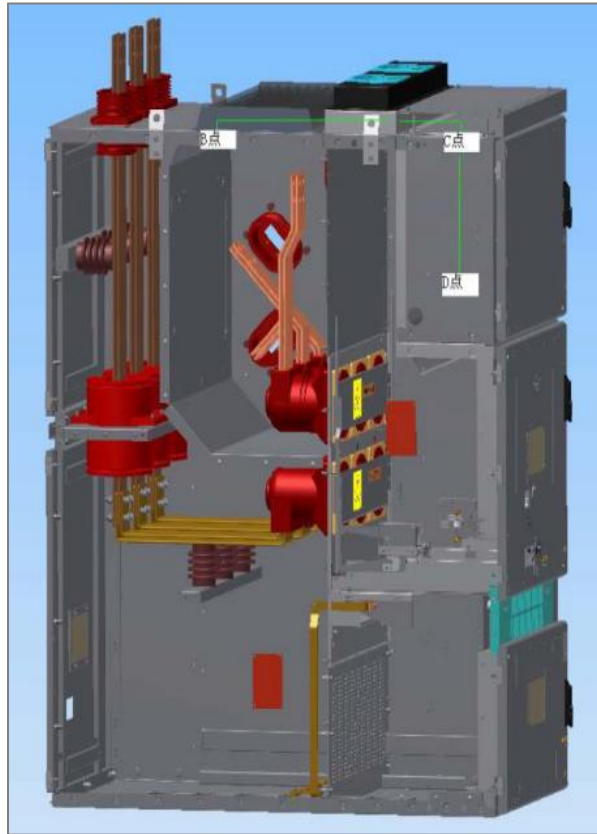

2) 手车室

2) Handcart room

手车室安装弧光保护开孔图

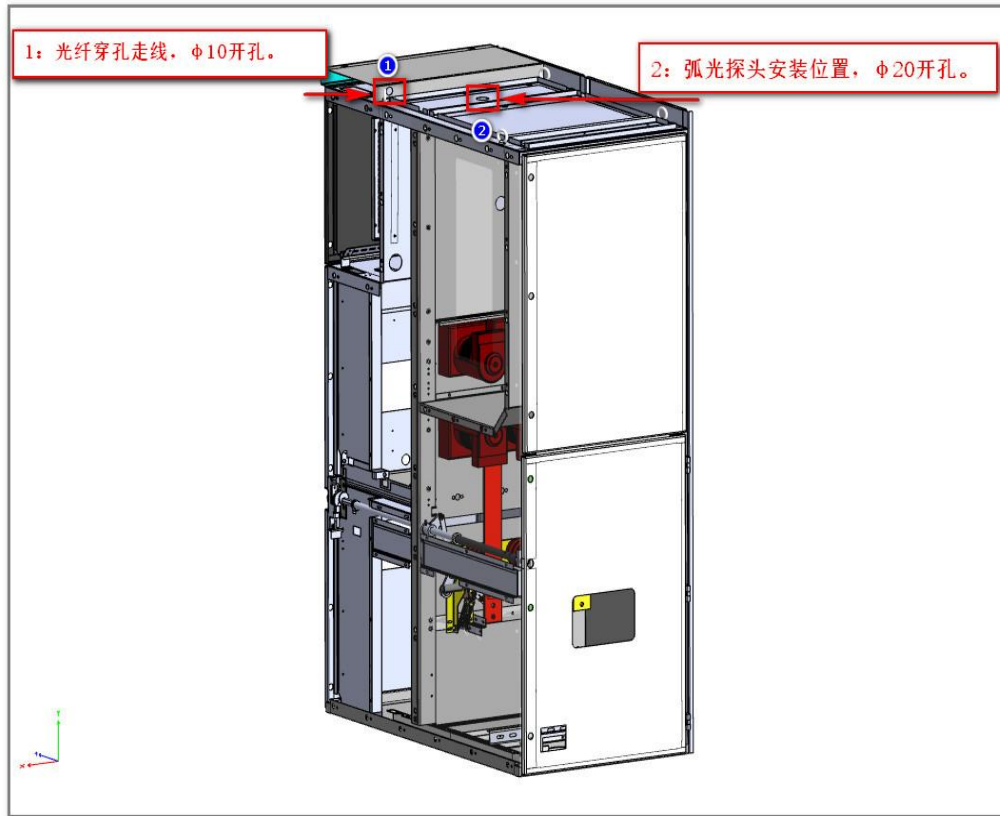

3) 电缆室

3) Cable room

电缆室安装弧光保护探头开孔

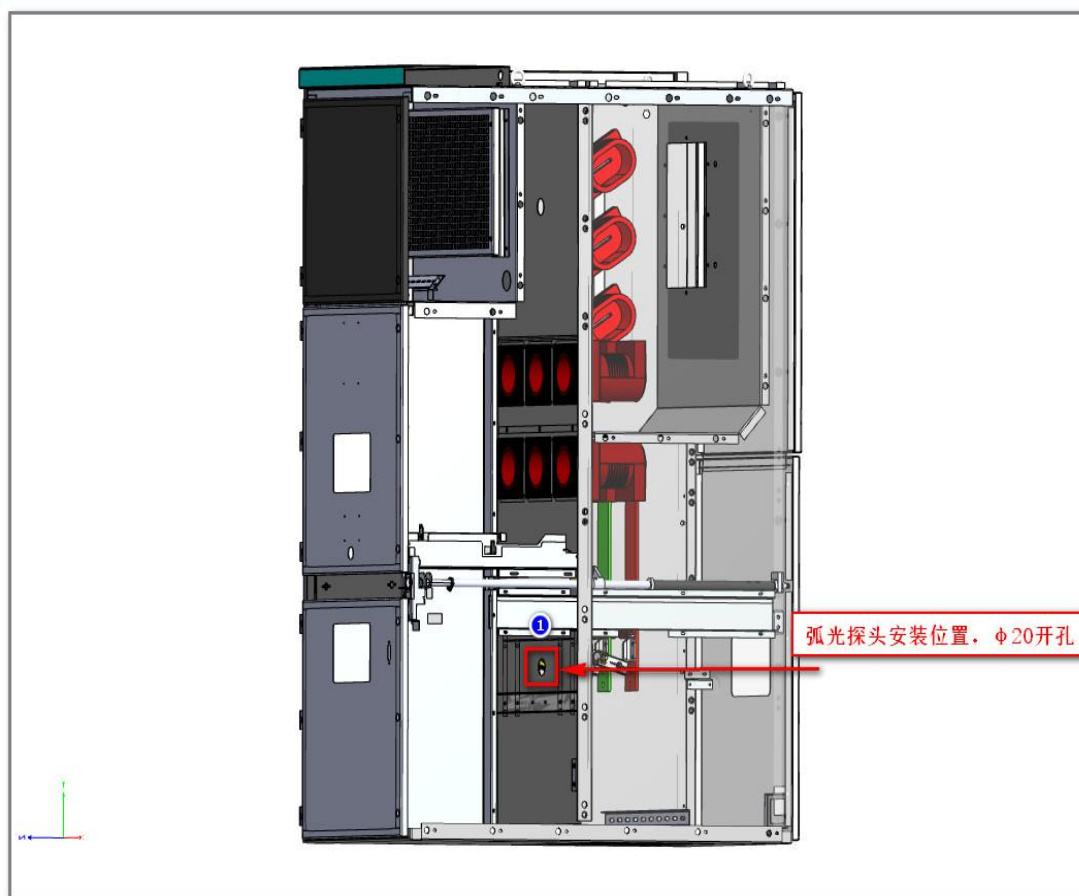

3.3 注意事项

3.3 Note

弧光传感器与弧光保护装置采用光纤连接，注意事项如下。

The arc sensor and arc protection device are connected using optical fibers, and the following precautions are required.

(1) 光纤避免在电缆沟或电缆桥架中敷设，不建议从开关柜现有的缝隙或螺孔穿过，如果通过缝隙或螺孔穿过，应做好孔的绝缘和保护工艺，避免屏体锐角对光纤造成损伤；

(1) Fiber optic cables should be avoided from being laid in cable trenches or cable trays. It is not recommended to pass through existing gaps or screw holes in the switchgear. If passing through gaps or screw holes, insulation and protection processes for the holes should be done to avoid damage to the fiber optic cables caused by sharp corners of the screen;

(2) 光纤敷设应远离母线、断路器触头及电缆接头等高压设备；

(2) Fiber optic cables should be laid away from high-voltage equipment such as busbars, circuit breaker contacts, and cable joints;

(3) 光纤敷设时必须考虑固定原件脱离时不能直接搭接至高压电气部分，防止光纤表

面积尘产生爬电现象；

(3) When laying optical fibers, it is necessary to consider that when the fixed components are detached, they cannot be directly overlapped to the high-voltage electrical part to prevent the phenomenon of crawling caused by dust on the surface of the optical fibers;

(4) 传感器安装位置和角度应考虑环境污染影响，应避开传感器感光面前方的各种遮挡和直射光源；

(4) The installation position and angle of sensors should consider the impact of environmental pollution, and avoid various obstructions and direct light sources in front of the sensor's photosensitive surface;

(5) 光纤建议采用点位片或扎带固定。

(5) Fiber optic cables are recommended to be fixed with point patches or ties.

其他安装事宜，请参阅《NB/T 42076-2016 弧光保护装置选用导则》中的“附录 B 弧光保护装置典型安装”章节。

For other installation matters, please refer to the "Appendix B Typical Installation of Arc Protection Devices" section in the "NB/T 42076-2016 Arc Protection Device Selection Guidelines".

4 装置操作说明

4 Operational Manual

4.1 前面板说明

4.1 Surface

装置的人机交互主要在面板上进行，包括三个部分：液晶显示、LED 灯指示和按键。

The human-computer interaction of the device is mainly carried out on the panel, including three parts: LCD display, LED light indication, and buttons.

液晶显示屏采用 256*160 点阵，可以显示弧光强度、电流、电压等遥测量值、遥信量、事件记录、故障录波、通信参数、定值参数、装置时间、装置版本号信息等。

The LCD display screen adopts a 256 * 160 dot matrix, which can display remote measurement values such as arc intensity, current, voltage, remote signal quantity, event recording, fault recording, communication parameters, fixed value parameters, device time, device version number information, etc.

LED 灯用来指示装置的运行状态、跳闸、告警、通信、链路、异常等信息，也可根据用户需要进行定制，图 4.1 中为出厂默认配置。

LED lights are used to indicate the operating status, tripping, alarm, communication, link, abnormality, and other information of the device. They can also be customized according to user needs. Figure 4.1 shows the factory default configuration.



图 4.1 ARB6 前面板
Figure 4.1 ARB6 Front Panel

4.2 按键说明

4.2 Key instructions

按键包括上、下、左、右、确认键、返回键及复归键，实现人机交互功能。

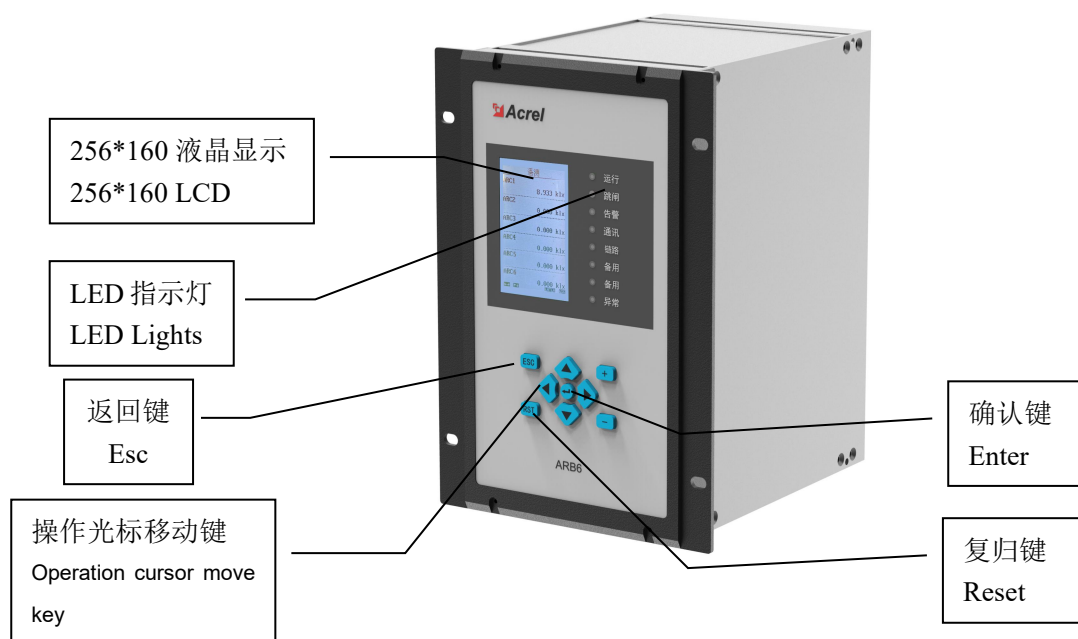
The keys include up, down, left, right, enter, return and function keys to realize human-computer interaction.

表 4.2 ARB6 按键功能说明
Table 4.2 ARB6 Key Function Description

按键 Key	主要功能 Function	按键 Key	主要功能 Function
	确认 Enter		向上移动选项或数字增大 Up/Increase
	复归 Reset		向下移动选项或数字减小 Down/Decrease

Esc	返回 Esc		向左移动选项或页面前翻 Left
			向右移动选项或页面后翻 Right

4.3 菜单说明

4.3 Menu instructions

装置上电即进入主界面，主界面分四个界面显示：运行界面、遥测界面、遥信界面、出口映射界面，如图 4.2~4.5 所示。各个界面之间可以通过左右键来切换显示。

When the device is powered on, it enters the main interface, which is divided into four interfaces for display: operation interface, telemetry interface, remote signaling interface, and exit mapping interface, as shown in Figures 4.2-4.5. The display can be switched between different interfaces through left and right keys.

ARB6	
I_IA	0.000 A
I_IB	0.000 A
I_IC	0.000 A
II_IA	0.000 A
II_IB	0.000 A
II_IC	0.000 A
III_IA	0.000 A
III_IB	0.000 A
III_IC	0.000 A
IV_IA	0.000 A
IV_IB	0.000 A
IV_IC	0.000 A
	50.0 Hz

图 4.2 运行界面

Figure 4.2 Running Interface

遥测			RemoteMeter		
ARC1	0.000	k1x	ARC1	0.000	k1x
ARC2	0.000	k1x	ARC2	0.000	k1x
ARC3	0.000	k1x	ARC3	0.000	k1x
ARC4	0.000	k1x	ARC4	0.000	k1x
ARC5	0.000	k1x	ARC5	0.000	k1x
ARC6	0.000	k1x	ARC6	0.000	k1x

图 4.3 遥测界面

Figure 4.3 Telemetry Interface

遥信		RemoteSignal	
检修状态	分	Maintenance	OFF
信号复归	分	ResetSignal	OFF
远方指示	分	Remote	OFF
非电量1	分	Non-elec. 1	OFF
非电量2	分	Non-elec. 2	OFF
非电量3	分	Non-elec. 3	OFF
非电量4	分	Non-elec. 4	OFF
备用	分	DI8	OFF
备用	分	DI9	OFF
备用	分	DI10	OFF
备用	分	DI11	OFF
备用	分	DI12	OFF

图 4.4 遥信界面

Figure 4.4 Remote Communication Interface

出口映射	DO Mapping
弧光保护1组 00000 00000 00000 0	ArcGroup1 00000 00000 00000 0
弧光保护2组 00000 00000 00000 0	ArcGroup2 00000 00000 00000 0
弧光保护3组 00000 00000 00000 0	ArcGroup3 00000 00000 00000 0
弧光保护4组 00000 00000 00000 0	ArcGroup4 00000 00000 00000 0
弧光保护5组 00000 00000 00000 0	ArcGroup5 00000 00000 00000 0
弧光保护6组 00000 00000 00000 0	ArcGroup6 00000 00000 00000 0

图 4.5 出口映射界面

Figure 4.5 Export Mapping Interface

出口映射界面中，保护出口与开出继电器的映射关系如下表中 1-16 位二进制数表示。

In the export mapping interface, the mapping relationship between the protection export and the output relay is represented by a 1-16 bit binary number in the table below.



1	2	3	4	5	6	7	8	9	10	11	12	13	14	15	16
0	0	0	0	0	0	0	0	0	0	0	0	0	0	0	0

第 1~16 位分别表示无源开出 DO1~DO16，其中 DO1~DO14 为常开接点（其中 DO1~DO4 为快速出口），DO15~DO16 为常闭接点。若序号 1~16 中某位为 1 时，表示保护功能动作（跳闸或者告警）配置到该出口；若为 0 时，表示未配置到该出口。

The 1st to 16th bits respectively represent passive outputs of DO1 to DO16, where DO1 to DO14 are normally open contacts (where DO1 to DO4 are fast outputs), and DO15 to DO16 are normally closed contacts. If one of the digits in numbers 1-16 is 1, it indicates that the protection function is activated (tripped or alarmed) and configured to that exit; If it is 0, it indicates that the exit has not been configured.

4.3.1 快速导航

4.3.1 Fast navigation

装置菜单为多级菜单，在任一幅主界面里按“”确认键即进入主菜单，主菜单分为 9 个子菜单，如图 4.6，由子菜单名称、图标构成。选定任一子菜单后按“”确认键进入菜单，按“”返回键返回上级菜单。图 4.7 为装置的快速导航示意图，可以依据该图迅速查找相关参数。

The device menu is a multi-level menu. Press the confirm button in any main interface to enter the main menu. The main menu is divided into 9 sub menus, as shown in Figure 4.6, consisting of sub menu names and icons. After selecting any submenu, press the confirm button to enter the menu, and press the return button to return to the higher-level menu. Figure 4.7 is a quick navigation diagram of the device, which can be used to quickly search for relevant parameters.



图 4.6 主菜单
Figure 4.6 Main Menu







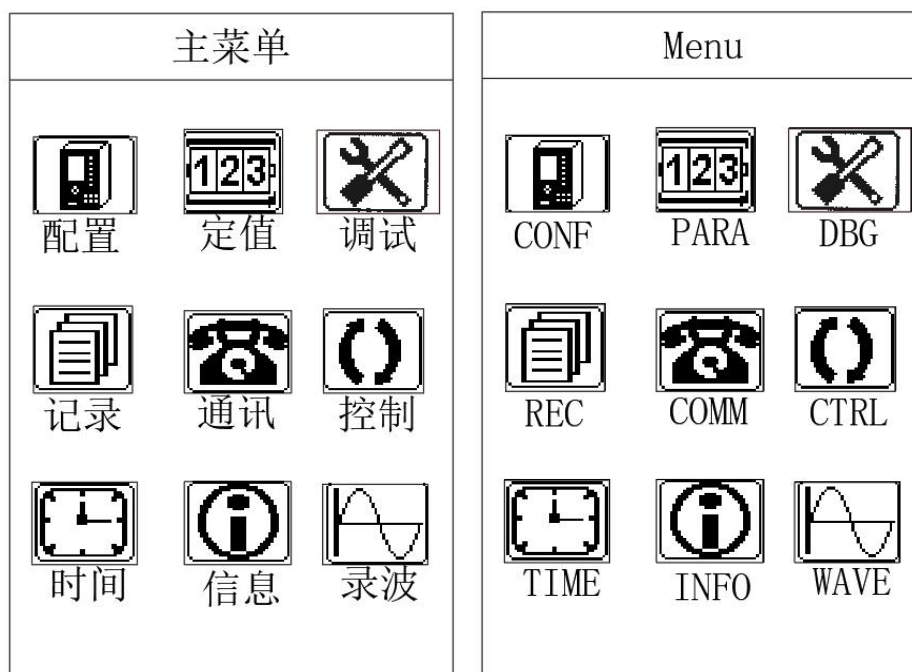
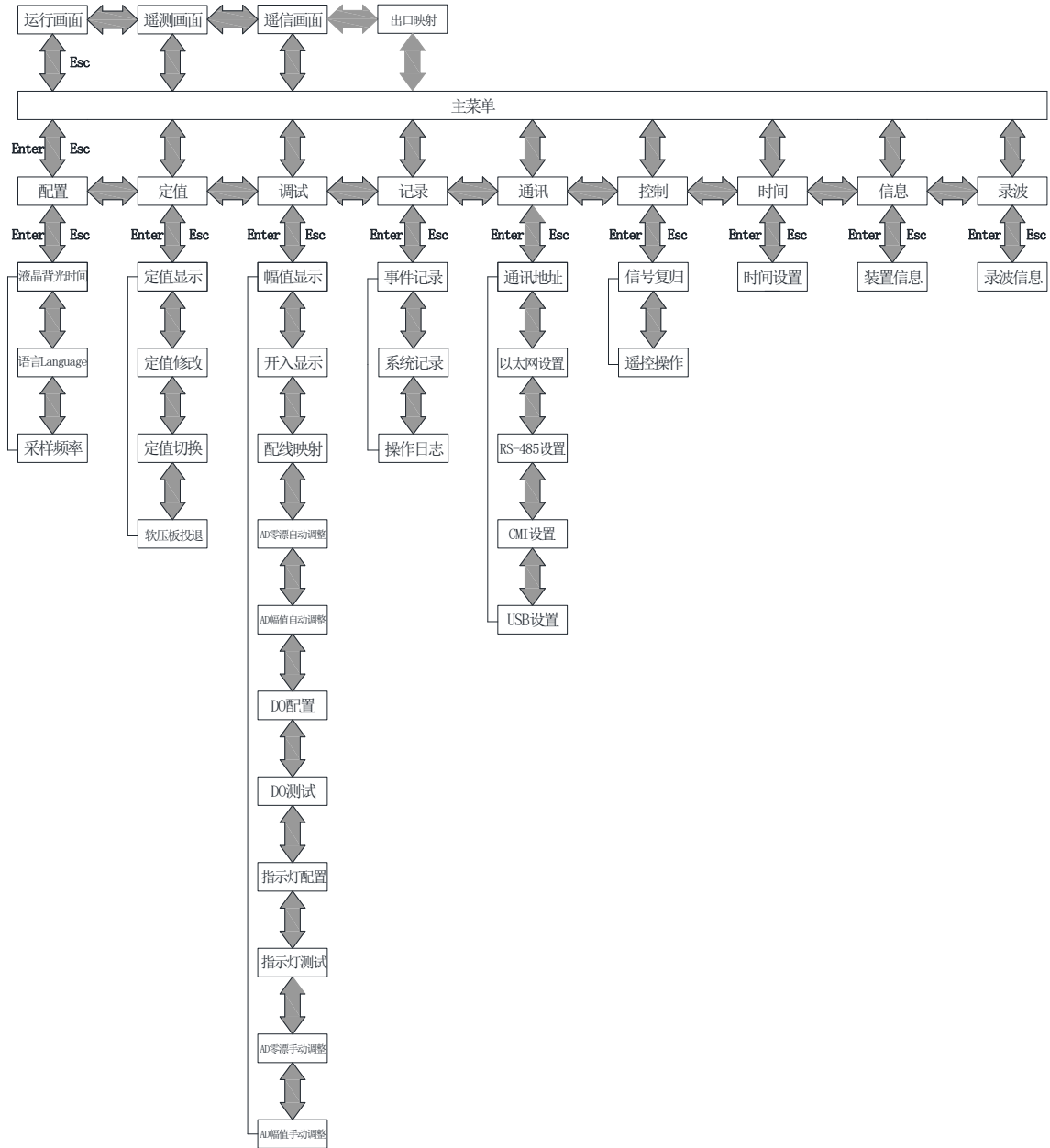

图 4.7 快速导航示意图
Figure 4.7 Quick Navigation Diagram

4.3.2 配置

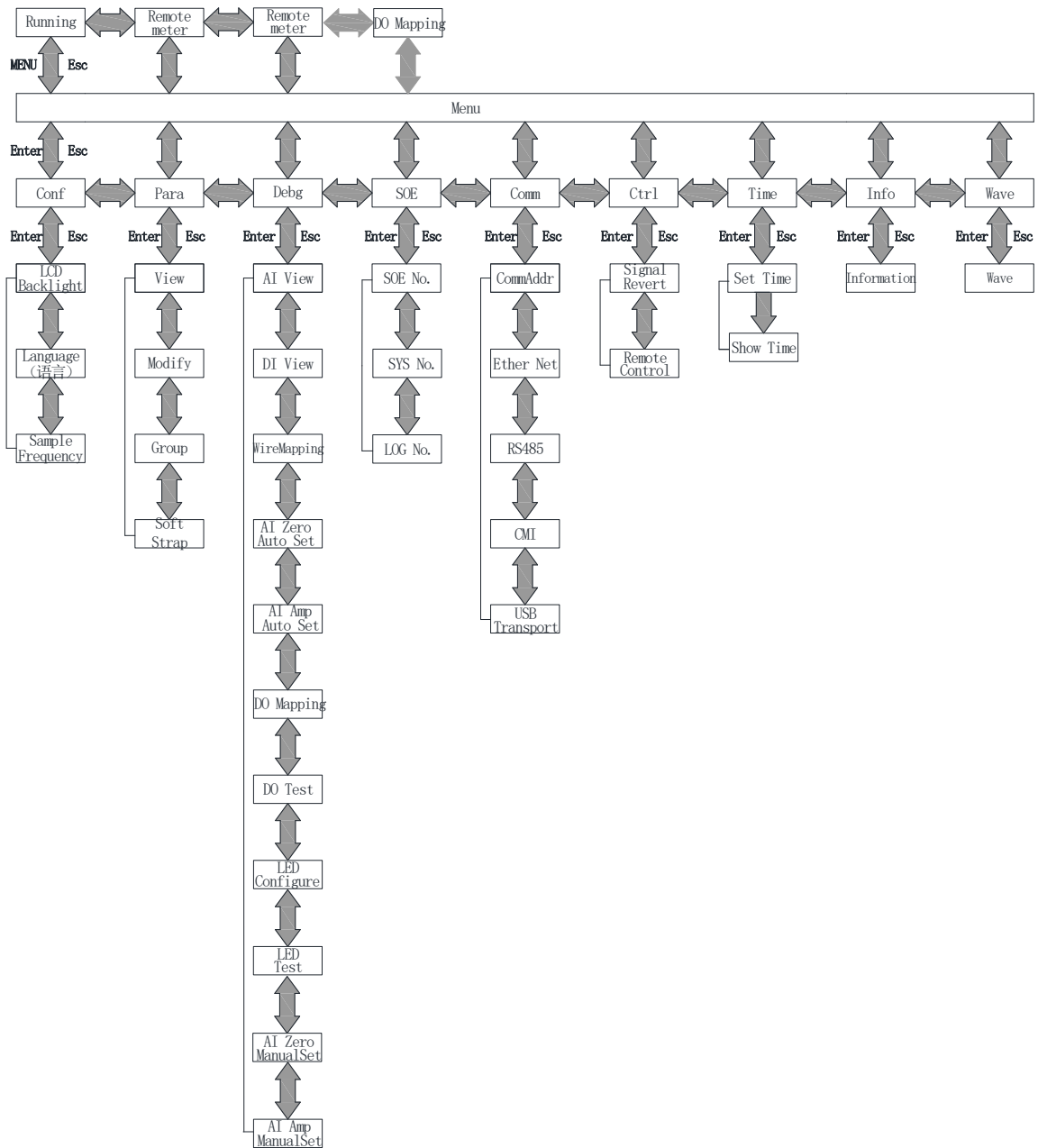
4.3.2 Configuration

“配置”菜单可以设置液晶背光时间、语言、采样频率，如图 4.8，修改完成后，按“”确认键退出修改，再按“”返回键返回，装置会跳出数据保存界面，如图 4.9，按“”确认键保存修改并返回主菜单，按“”返回键不保存修改且返回主菜单。

The "Configuration" menu can set the LCD backlight time, language, and sampling frequency, as shown in Figure 4.8. After the modification is completed, press the "Confirm" button to exit the modification, and then press the "Return" button to return. The device will pop up the data saving interface, as shown in Figure 4.9. Press the "Confirm" button to save the modification and return to the main menu. Press the "Return" button to not save the modification and return to the main menu.



图 4.8 液晶背光时间设置

Figure 4.8 LCD backlight time setting



图 4.9 数据保存提示

Figure 4.9 Data saving

4.3.3 定值

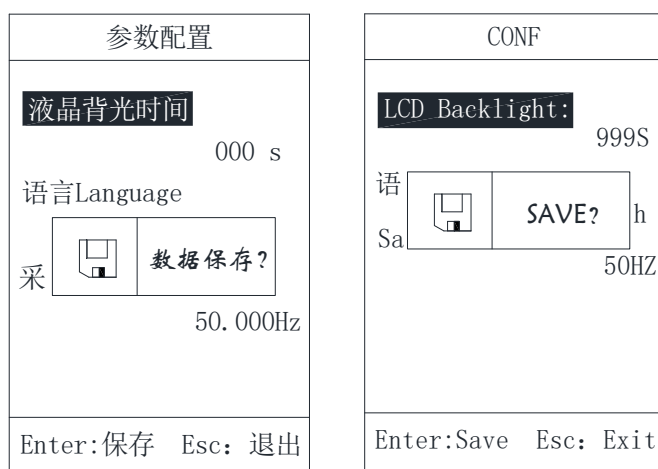

4.3.3 Parameter

“定值”菜单里有定值显示、定值修改、定值切换、软压板投退四个子菜单，如图 4.10。

The "Para." menu has four sub menus: Value View, Value modify, Switch Group, and Soft Strap, as shown in Figure 4.10.

4.3.3.1 定值显示

4.3.3.1 Value View

“定值显示”菜单中有选择定值区、运行定值区两个子菜单。选择定值区里有四组有效定值，分别为00、01、02、03四个区号，选择相应区号，如图4.11，按“”确认键进入定值显示。所有定值分页显示，按“”左、“”右键可分页查看，如图4.12。运行定值区里显示装置当前运行的定值区。

The "Value View" menu has two submenus, which are selected value section and running value section. The selected value section has 4 section:00,01,02 and 03,as shown in figure4.11. Each section can be set different values. The running value section is shown the nowadays value, all value pagination displays, press left and right key to view, as shown in figure 4.12.



图 4.10 定值菜单

Figure 4.10 Parameter



图 4.11 设置选择定值区

Figure 4.11 Selection area

定值显示[00] (001)	View[00] (001)
1#电流接线方式 3CT	1#I Mode 3CT
2#电流接线方式 3CT	2#I Mode 3CT
3#电流接线方式 3CT	3#I Mode 3CT
4#电流接线方式 3CT	4#I Mode 3CT
额定二次电流 (Ie) 5.000A	Ie 5.000A
额定二次电压 (Ue) 100.000V	Ue 100.000V

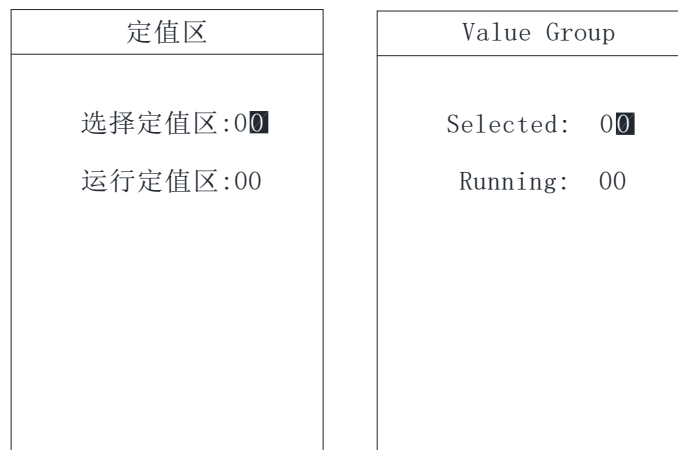

图 4.12 定值显示
Figure 4.12 View

4.3.3.2 定值修改

4.3.3.2 Modify

“定值修改”菜单有选择定值区、运行定值区两个子菜单，该菜单初始密码为“0008”。

The “Modify” menu has two submenus in the selected value area and the running value area. The initial password of this menu is “0008”.

在选择定值区内设置需修改的定值区号，按“”确认键进入定值修改界面。这里分页显示所有定值信息，可通过“”上、“”下、“”左、“”右键选择需修改的定值，先按“”确认键，再按“”上、“”下设置修改内容，如图 4.14。修改完成后，按“”确认键确定，再对下一个需修改的定值进行修改，待全部定值修改完成后，再按“”返回键退出，这时若数据有改动，则装置会弹出同图 4.9 所示的数据保存对话框，按“”确认键保存修改并返回定值管理菜单，按“”返回键不保存且返回定值管理菜单。

Set the value area code to be modified in the fixed value area, and press “Enter” to enter the value modification interface. Here pagination displays all the value information, and use can select the value that needs to be modified by selecting the left and right keys, press the “Enter” button first, and then press the up and down key to set the modified content, as shown in figure 4.14. After the set is completed, press the “Enter” button, then set the next one as the same way.

When the all setting is completed, press “Esc” button to exit, at this time if the data changes, the device will pop up with the data dialog box shown in figure 4.9, press “enter” button to save the changes and return to value management menu, click “Esc” button is not saved and to return to value management menu.

运行定值区只显示装置当前运行的定值区号，这里不做修改。

The running value area only displays the current running value area of the device. and no modification is made here.



图 4.13 输入密码对话框

Figure 4.13 entering password

定值修改[00] (001)	Modify[00] (001)
1#电流接线方式 3CT	1#I Mode 3CT
2#电流接线方式 3CT	2#I Mode 3CT
3#电流接线方式 3CT	3#I Mode 3CT
4#电流接线方式 3CT	4#I Mode 3CT
额定二次电流 (Ie) 5.000A	Ie 5.000A
额定二次电压 (Ue) 100.000V	Ue 100.000V

图 4.14 定值修改

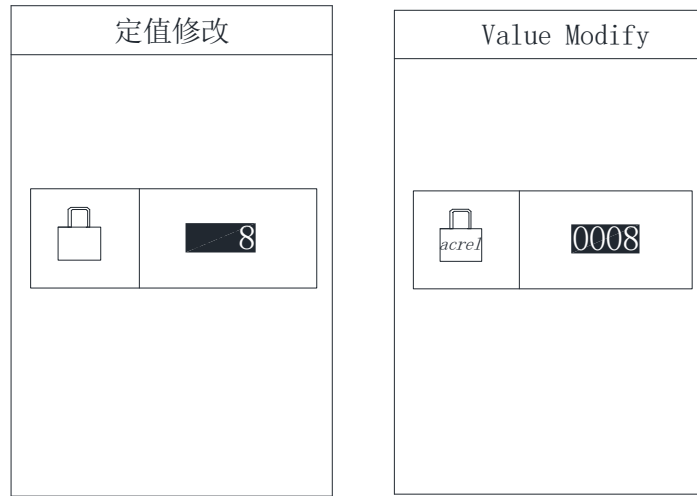

Figure 4.14 Value Modify



图 4.15 定值切换
Figure 4.15 Switch Group

4.3.3.3 定值切换









4.3.3.3 Switch Group



“定值切换”菜单有切至定值区、运行定值区两个子菜单，该菜单初始密码为“0008”。切至定值区内有 00-03 四个有效定值区可供切换，设置好后，按“”确认键确定，再按“”返回键返回主菜单。运行定值区将显示当前运行的定值区号，如图 4.15。

The “Switch Group” menu has two sub-menus: selected value section and running value section. The password of this menu is “0008”. The selected section shows the expected section users want to set, which can be set as 00-03. After making the selection, press the “Enter” button to determine, and then press the “esc” key to return to the main menu. The running value section will display the current running value area of the device, as shown in Figure 4.15.

4.3.3.4 软压板投退

4.3.3.4 Soft Strap

“软压板投退”菜单初始密码为“0008”，按“”确认键进入软压板投退修改界面。这里分页显示所有软压板投退信息，可通过“”上、“”下、“”左、“”右键选择需修改的软压板，先按“”确认键，再按“”上、“”下设置修改内容，如图 4.16。修改完成后，按“”确认键确定，再对下一个需修改的软压板进行修改，待

全部定值修改完成后，再按“”返回键退出，这时若数据有改动，则装置会弹出同图 4.9 所示的数据保存对话框，按“”确认键保存修改并返回定值管理菜单，按“”返回键不保存且返回定值管理菜单。

The password for the "Soft Strap" menu is "0008". Press the confirmation button to enter the Soft Strap interface. Here, all the input and output information of the Soft Strap is displayed in pages. You can select the Soft Strap to be modified by pressing the "up", "down", "left", and "right" buttons. First, press the "confirm" button, and then press the "up" and "down" buttons to set the modification content, as shown in Figure 4.16. After the modification is completed, press the confirm button to confirm, and then modify the next Soft Strap that needs to be modified. After all fixed are completed, press the return button to exit. If there are any changes to the data, the device will pop up a data saving dialog box as shown in Figure 4.9. Press the confirm button to save the modifications and return to the main menu. Press the return button to not save and return to the main menu.



图 4.16 输入密码对话框
Figure 4.16 entering password

软压板投退		Soft Strap	
探头1	投入	ARC1. E	ON
探头2监测使能	退出	ARC2. E	OFF
探头3监测使能	退出	ARC3. E	OFF
探头4监测使能	退出	ARC4. E	OFF
探头5监测使能	退出	ARC5. E	OFF
探头6监测使能	退出	ARC6. E	OFF

图 4.17 软压板投退修改
Figure 4.17 Soft Strap modify

4.3.4 调试

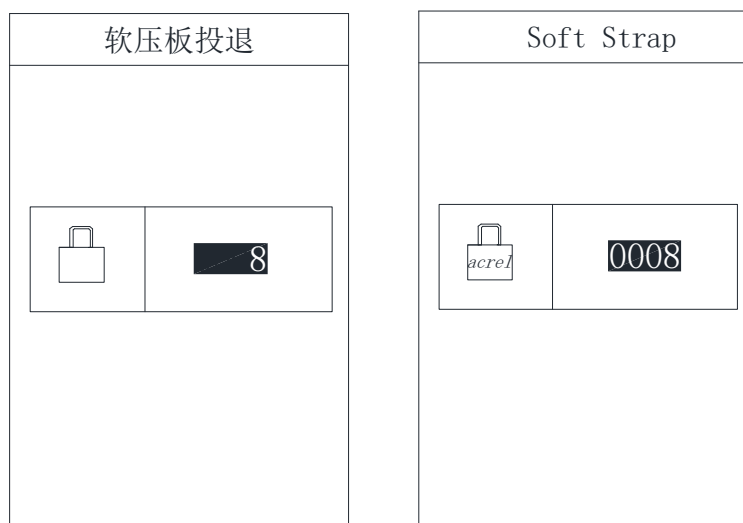
4.3.4 Debugging

“调试”菜单用于装置出厂前的测试，可对装置进行零漂调整、幅值调整、继电器输出测试、继电器输出配置、指示灯输出测试、指示灯颜色等配置。

The "Debg" menu is used to test the device before it leaves the factory. The function includes zero adjustment, amplitude adjustment, relay output test, indicator output test, indicator color configuration, and relay output configuration.

该菜单功能使用时请与制造商联系。

Please contact the manufacturer when using this menu function.

4.3.5 记录

4.3.5 Record

“记录”菜单中可以查看事件记录、系统记录、操作日志三类信息。

In the "REC" menu, users can view three types of information: SOE Record、SYS Record and LOG Record.

4.3.5.1 事件记录

4.3.5.1 SOE Record

“事件记录”菜单可显示事件序号、事件总数、事件代码、事件发生时间、事件名称、动作类型（动作或告警）等信息。如果是保护动作引起的事件记录，还会记录事件发生时刻动作元件动作值和时间，如图 4.18 所示。装置可保存不少于 200 条事件记录。

The "SOE Record" menu displays the event sequence, total number of events, event code, event time, event name, action type (action or alarm), and other information. If the event is caused by a protection action, the action value and time of the action element at the time of the event are also recorded, as shown in Figure 4.18. The device can save over 200 event records.

4.3.5.2 系统记录

4.3.5.2 SYS Record

“系统记录”菜单可显示系统记录序号、系统记录总数、系统记录时间、系统记录名称、系统记录码等信息，如图 4.19 所示。装置可保存不少于 500 条系统记录。

The "SYS Record" menu displays the system records sequence, total number of system records, system records time, system records name, system records code and other information, as shown in Figure 4.19. The device can save more than 500 records.

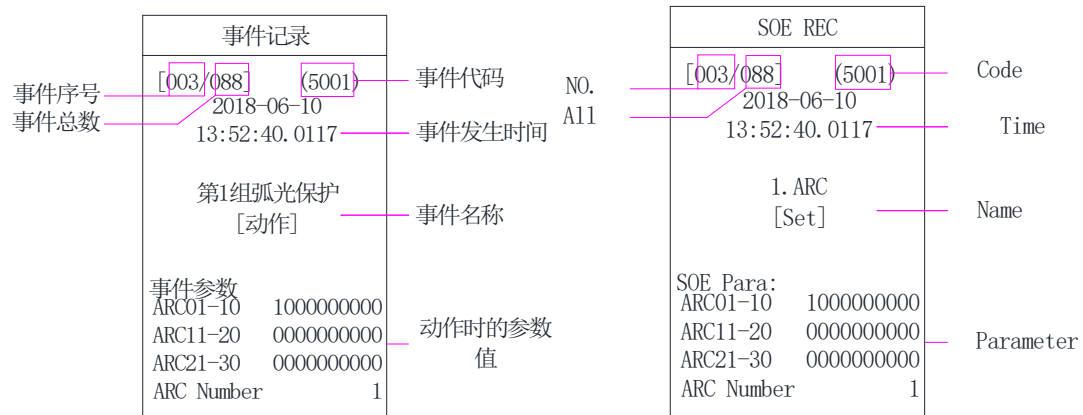

事件记录	SOE REC
[002/088] (5501)	[002/088] (5501)
2018-06-10 13:52:40.0017	2018-06-10 13:52:40.0017
探头1动作 [动作] 事件参数	ARC1.Ex [Set] SOE Para:
ARC1 10.064k1x	ARC1 10.064k1x

图 4.18 事件记录画面

Figure 4.18 Event record screen

系统记录	SYS Rec
[003/099]	[003/099]
2018-06-10 13:56:40	2018-06-10 13:56:40
软件属性初始化 Code: 0x00000003	Software Init code: 0x00000003

图 4.19 系统记录画面

Figure 4.19 System record screen

4.3.5.3 操作日志

4.3.5.3 System log

如图 4.20 所示，“操作日志”菜单记录装置所有的操作行为、设置变更行为等信息。装置可保存不少于 2000 条系统记录。

As shown in Figure 4.20, the "System Log" menu records all operation and setting changes of the device. The device can save more than 2000 records.

操作日志 [001/033]	LOG Rec [001/033]
20011223-123456.0123	20011223-123456.0123
Device power on/off ON	Device power on/off ON

图 4.20 操作记录画面
Figure 4.20 Log record screen

4.3.6 通讯

4.3.6 Communication

“通讯”菜单可设置装置通讯地址及通讯方式，如图 4.21。装置通讯地址设置如图 4.22 所示，通讯方式有以太网接口、RS485 接口、CMI 接口、USB 接口共 4 种接口的设置。

As shown in Figure 4.21, the "Comm" menu can set the device's communication address and mode. Figure 4.22 shows the device's communication address set, and the communication mode has four interface settings: Ethernet interface, RS485 interface, RS232 interface, and USB interface.

如图 4.23 和表 4.3，可设置三路以太网口（A 网、B 网和 C 网）通讯参数。

As shown in Figure 4.23 and Table 4.3, three Ethernet ports (A network, B network and C network) communication parameters can be set.

表 4.3 以太网口通讯参数设置

Table 4.3 Ethernet port communication parameters setting

本地 TCP 模式 Local TCP mode	按需设置，同一网内可设为相同 Set on demand, can be set to the same within
本地 TCP 端口 Local TCP port	按需设置，同一网内可设为相同 Set on demand, can be set to the same within the same network
本地 UDP 端口 Local UDP port	按需设置，同一网内可设为相同 Set on demand, can be set to the same within the same network
本地 Mac 地址	同一网内不可重复



Local Mac address	Non-repeatable within the same network
本地 IP 地址	同一网内不可重复
Local IP address	Non-repeatable within the same network
远程 TCP 端口	即后台机的端口，同一网内可设为相同
Remote TCP port	The TCP of the backend machine, which can be set to the same within the same network
远程 IP 地址	即后台机的 IP 地址，同一网内可设为相同
Remote IP address	The IP of the backend machine, which can be set to the same within the same network
网关	按需设置，同一网内可设为相同
Gateway	Set on demand, can be set to the same within the same network
子网掩码	按需设置，同一网内可设为相同
Subnet Mask	Set on demand, can be set to the same within the same network

如图 4.24，可设置两路 RS485 口（com1 和 com2）通讯参数。

As shown in Figure 4.24, the communication parameters of two RS485 ports (com1 and com2) can be set.

如图 4.21，可直接进入“USB 设置”（装置程序升级）或“CMI 设置”菜单。**该菜单功能使用时请与制造商联系。**

As shown in Figure 4.21, users can directly enter the "USB Transport" menu to upgrade the program of the device, and enter the "CMI" menu . **Please contact the manufacturer when using this menu function.**

通讯参数可从表 4.4 选择参数进行设置。设置完成后先按“”返回键退出，然后按“”确认键保存后再按“”返回键返回主菜单。

Communication parameters can be set by selecting parameters from Table 4.4. After setting, press "Esc" to exit, then press "Enter" to save and then press "Esc" to return to the main menu.

通讯	COMM
<p>通讯地址</p> <p>以太网设置</p> <p>RS-485设置</p> <p>CMI设置</p> <p>USB传输</p>	<p>CommAddr</p> <p>Ether Net</p> <p>RS-485</p> <p>CMI</p> <p>USB Transport</p>

图 4.21 通讯设置界面

Figure 4.21 Communication menu

通讯地址	CommAddr
<p>通讯地址 00001</p>	<p>CommAddr 00001</p>

图 4.22 装置地址设置界面

Figure 4.22 Device address setting interface

以太网设置 A网	Ether Net Enet_A
规约: Modbus	Protocol: Modbus
本地TCP模式: Server	LocalTcpMode: Server
本地TCP端口: 07710	LocalTcpPort: 7710
本地UDP端口: 01032	LocalUdpPort: 1032
本地Mac地址: 00-08-DC-65-6C-41	LocalMacAddr: 00-08-DC-65-6C-41
本地IP地址: 192.168.001.002	LocalIpAddress: 192.168.001.002

图 4.23 以太网设置界面

Figure 4.23 A_net communication parameters

RS-485设置		RS-485	
COM1 规约	Modbus	COM1 Protocol	Modbus
COM1 波特率	57600	COM1 Baudrate	57600
COM1 数据位	8	COM1 DataBit	8
COM1 停止位	1	COM1 StopBit	1
COM1 校验方式	无校验	COM1 Parity	NONE
COM2 规约	Modbus	COM2 Protocol	Modbus

图 4.24 RS485 设置界面

Figure 4.24 RS-485 communication parameters

表 4.4 通讯参数设置

Table 4.4 Communication parameter setting

设置量 Setting quantity	参数 Parameter
装置地址 Device address	0~255
波特率 Baud rate	110、300、600、1200、2400、4800、9600、14400、19200、38400、56000、57600、115200、128000、256000
数据位 Data bits	8、9
停止位 Stop bits	1、1.5、2
校验方式 Calibration mode	无校验、偶检验、奇校验 No calibration, Even calibration, Odd calibration
规约选择 Protocol selection	Modbus、IEC101、IEC103、LoopBack、IRIG-B
本地 TCP 模式 Local TCP mode	Server、Client

4.3.7 控制

4.3.7 Control

“控制”菜单用于装置出厂前的测试，可对装置进行遥控分闸、遥控合闸及信号复归操作。



The "Control" menu is used to test the device before it leaves the factory, which allows remote control of the device for breaking, closing, and signal restoration operations.

该菜单功能使用时请与制造商联系。

Please contact the manufacturer when using this menu function.

4.3.8 时间

4.3.8 Time

“时间”菜单用于修改时钟。如图 4.25，时间设置完成后按“”确认键即修改成功，再按“”返回键返回主菜单。

The "Time" menu is used to modify the clock. As shown in Figure 3.26, press the "Enter" button after the time setting is completed, then press the "Esc" button to return to the main menu.



图 4.25 时间设置

Figure 4.25 Time Setting

4.3.9 信息

4.3.9 Information

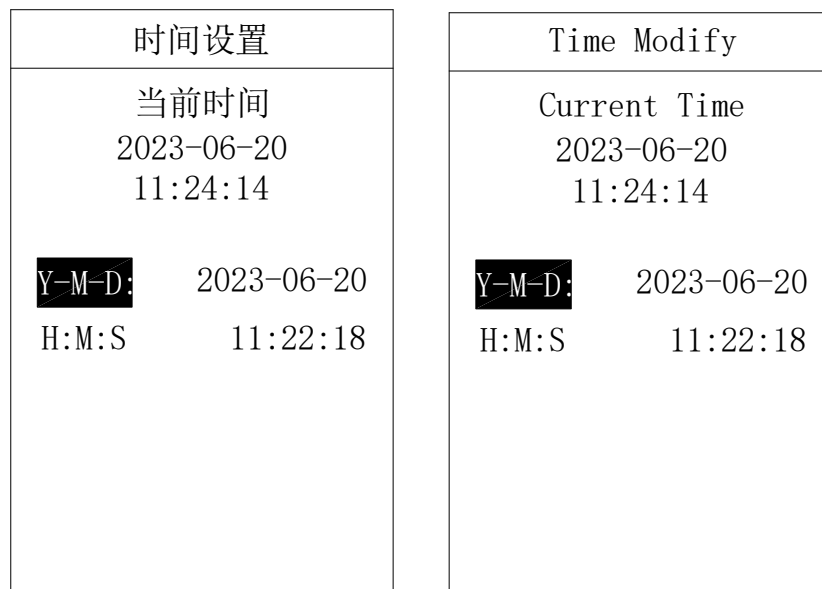
“信息”菜单可显示装置的基本信息包括装置名称、软件版本号、校验码、硬件配置生成时间、软件配置生成时间、保护逻辑图生成时间及逻辑图版本号等，如图 4.26 所示。

The "Information" menu can display the basic information of the device, including device name, software version number, check code, hardware configuration generation time, software configuration generation time, protection logic diagram generation time and logic diagram version number, etc., as shown in Figure4.26.

信息	INFO
ARB6	ARB6
版本号: 1.00	HalVer: 1.00
校验码: 0x1f37	CRC Code: 0x1f37
硬件配置:	Hardware:
2018-06-10_13:42:34	2018-06-10_13:42:34
软件配置:	Software:
2018-06-10_13:42:38	2018-06-10_13:42:38
逻辑版本: V0020 1.00	LogicVer: V0020 1.00
2018-06-10_15:50:46	2018-06-10_15:50:46

图 4.26 装置信息

Figure 4.26 Device information

4.3.10 录波

4.3.10 Waveform

“录波”菜单可直接显示保护功能动作时，装置储存的事故电流、电压、弧光强度波形数据。装置可保存不少于 16 条故障录波信息。

The "Wave" menu can directly display the waveform data of accident current, voltage, and arc intensity stored by the device when the protection function is activated. The device can store no less than 16 fault recording information.



图 4.27 录波数据

Figure 4.27 waveform data information

第二章 技术说明

Chapter 2 Technical Description

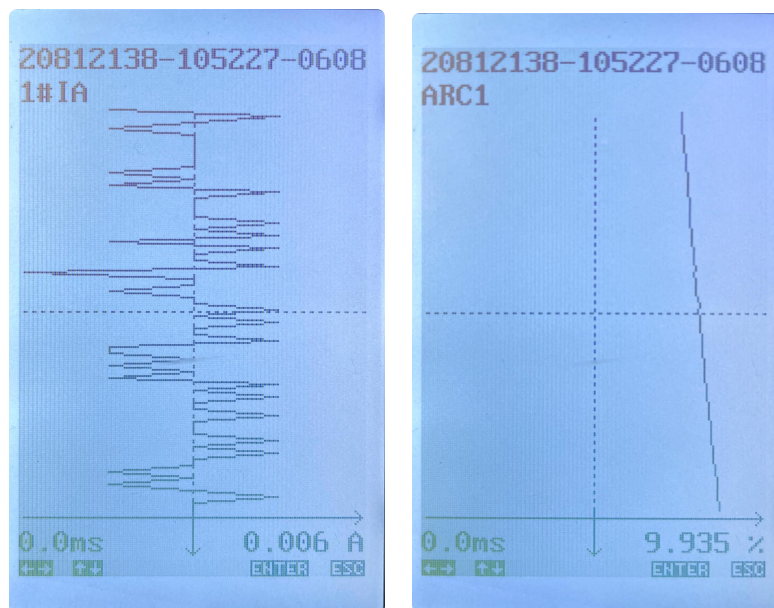
1 保护功能原理

1 Protection Principle

1.1 弧光保护

1.1 Arc protection

弧光保护启动判据可选三种：弧光单判据，弧光和电流双判据，弧光和零序电压双判据。

There are three possible criteria for starting arc protection: single arc criterion, arc and current criterion, and arc and zero sequence voltage criterion.

(1) 弧光单判据

(1) Single criteria for arc criterion

当弧光强度大于其整定值，经延时，弧光保护动作。

When the arc intensity exceeds its set value, after a delay, the arc protection will activate.



图1.1 弧光单判据保护逻辑示意图

Figure 1.1 Schematic diagram of arc single criterion protection logic

(2) 弧光和电流双判据

(2) Dual criteria for arc and current

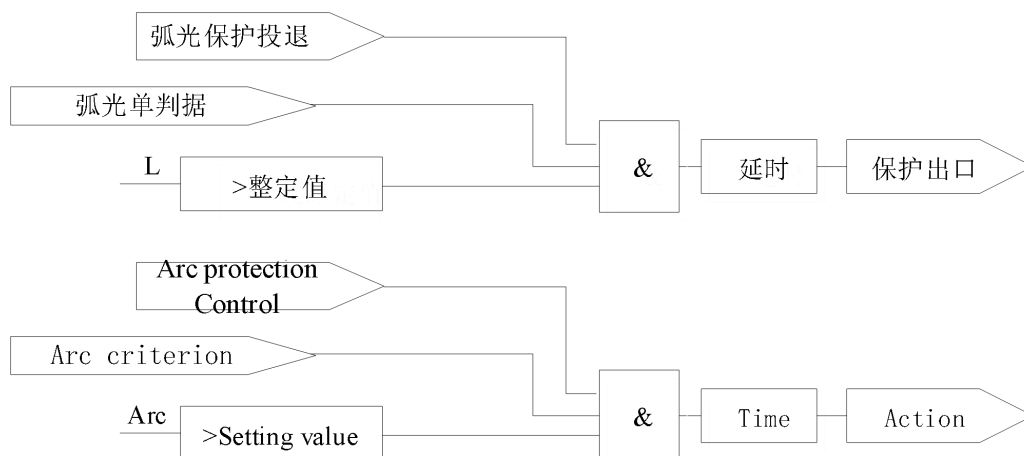
在发生弧光故障时，弧光光强会增大，电流值也会突变。弧光保护启动条件中加入电流判据，可有效排除外界光源干扰，提高可靠性。

When an arc fault occurs, the arc intensity will increase and the current value will suddenly change. Adding a current criterion to the starting conditions of arc protection can effectively eliminate interference from external light sources and

improve reliability.

当弧光光强大于其整定值,并且所关联的电流中任一电流值大于电流整定值时,经延时,弧光保护动作。

When the arc intensity is greater than its set value and any current value associated with it is greater than the current set value, the arc protection will activate after a delay.



图1.2 弧光和电流双判据保护逻辑示意图

Figure 1.2 Schematic diagram of dual criterion protection logic for arc and current

(3) 弧光和零序电压双判据

(3) Dual criteria for arc and zero sequence voltage

在不接地系统和消弧线圈接地系统,弧光保护启动条件中加入零序电压判据,可提高判别单相接地弧光故障的灵敏度。

Adding a zero sequence voltage criterion to the starting conditions of arc protection in ungrounded systems and arc suppression coil grounded systems can improve the sensitivity of identifying single-phase grounding arc faults.

当弧光光强大于其整定值,并且所关联的零序电压中任一电压值大于零序电压整定值时,经延时,弧光保护动作。

When the arc intensity is greater than its set value and any voltage value in

the associated zero sequence voltage is greater than the set value of the zero sequence voltage, after a delay, the arc protection will activate.



图1.3 弧光和零序电压双判据保护逻辑示意图

Figure 1.3 Schematic diagram of dual criterion protection logic for arc and zero sequence voltage

1.2 弧光监测及故障点定位功能

1.2 Arc monitoring and fault location function

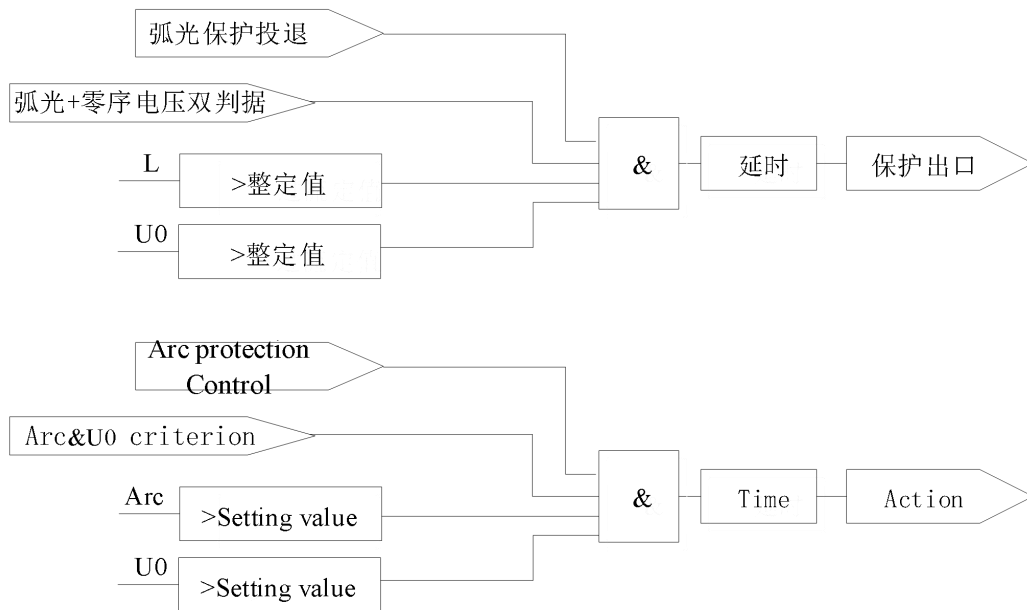
在投入“探头监测使能”软压板后，装置才能监测弧光传感器的实时光强值及传感器序号，并可通过“传感器光强值记录”控制字确定是否记录弧光传感器的光强值（当弧光光强大于整定值时）。“传感器光强值记录”控制字投入时，装置会记录每个弧光传感器的光强值；退出时，装置仍会实时监测弧光传感器的光强值，但不保存其光强值。

After the "sensor monitoring enable" soft pressing plate is put into operation, the device can monitor the real-time light intensity value and sensor serial number of the arc sensor, and can determine whether to record the light intensity value of the arc sensor through the "sensor light intensity value recording" control word (when the arc intensity is greater than the set value). When the "Sensor Light Intensity Record" control word is activated, the device will record the light intensity value of each arc sensor; When exiting, the device will still monitor the light intensity value of the arc sensor in real time, but will not save its light intensity value.

弧光故障触发弧光保护逻辑动作时，装置会结合弧光故障所在处的传感器序号和光强值，实现故障点定位功能。

When the arc fault triggers the arc protection logic action, the device will combine the sensor

serial number and light intensity value at the location of the arc fault to achieve the fault point positioning function.



图1.4 弧光传感器光强监测和弧光故障点定位逻辑示意图

Figure 1.4 Logic diagram of arc sensor intensity monitoring and arc fault location

1.3 弧光传感器及光纤链路监测

1.3 Arc sensor and fiber optic link monitoring

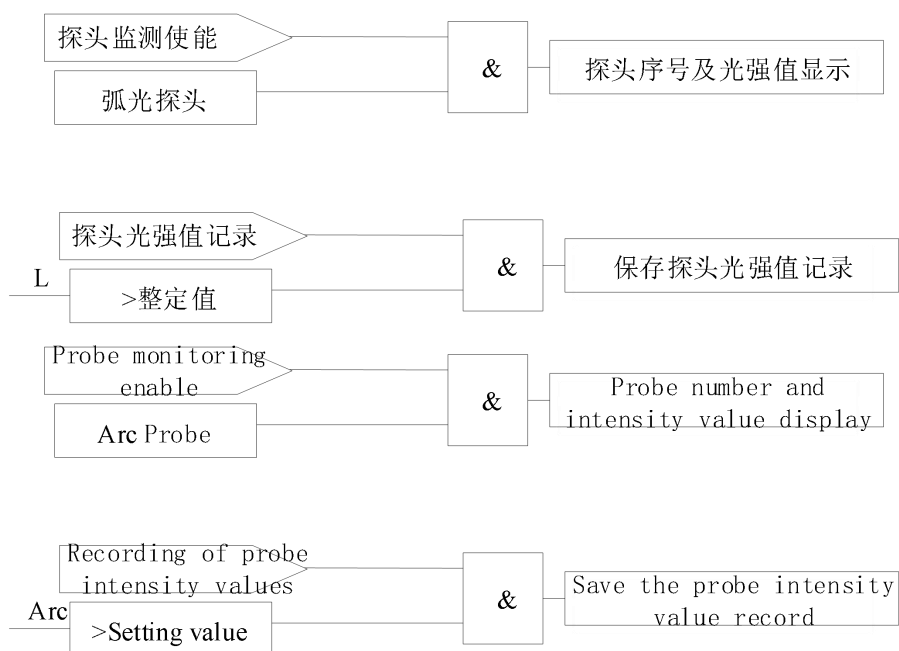
当投入“传感器监测使能”软压板后，装置实时监测各个弧光传感器的链路情况，当任一弧光传感器损坏或者其与弧光保护装置连接的光纤链路中断时，经延时，弧光链路自检告警。

When the "sensor monitoring enable" soft pressing plate is put into use, the device monitors the link situation of each arc sensor in real time. When any arc sensor is damaged or the fiber optic link connected to the arc protection device is interrupted, after a delay, the arc link self checks and alarms.

当弧光采集口不接传感器时，需退出相应的传感器监测使能软压板或者投入相应的闭锁传感器自检软压板，否则会报告该传感器链路自检异常。

When the arc acquisition port is not connected to a sensor, it is necessary to exit the corresponding sensor monitoring enable soft pressing plate or put in the corresponding locking sensor self check soft pressing plate, otherwise it will report an abnormal self check of the sensor link.



图 1.5 弧光传感器及光纤链路自检逻辑示意图

Figure 1.5 Schematic diagram of arc sensor and fiber optic link self-test logic

1.4 失灵保护

1.4 Failure protection

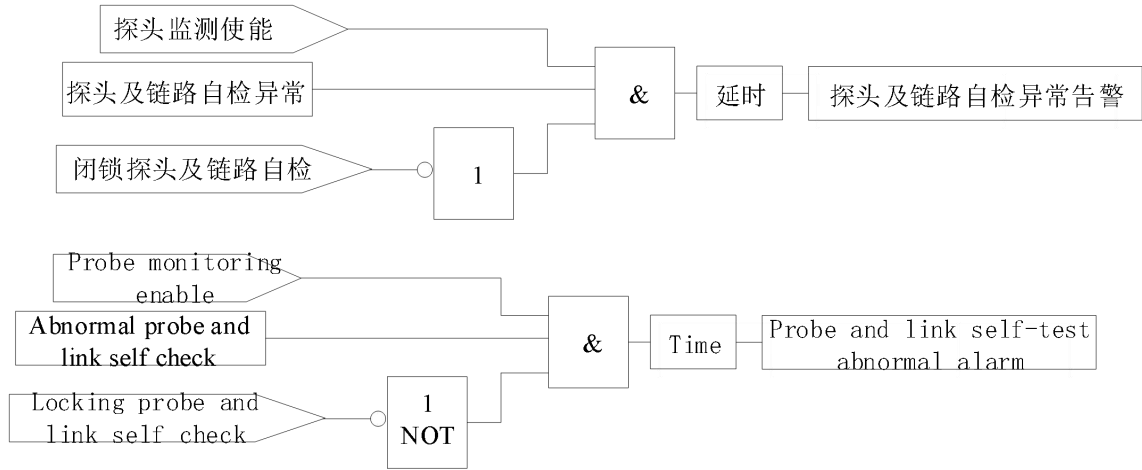
失灵保护逻辑可关联多组弧光保护和电流。当关联的弧光保护动作后，且关联的电流一直大于失灵定值，经延时，失灵保护动作。

The failure protection logic can be associated with multiple sets of arc protection and current. When the associated arc protection is activated and the associated current is consistently greater than the failure set value, the failure protection will activate after a delay.

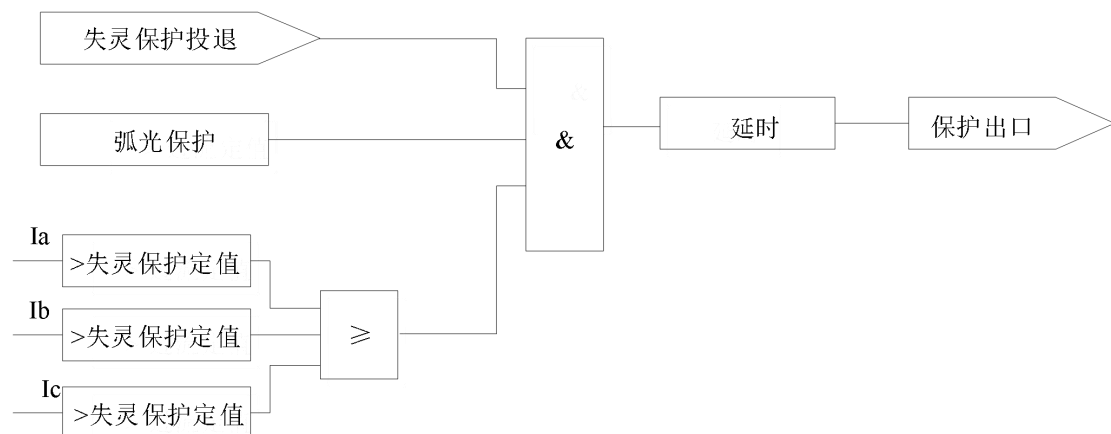



图 1.6 失灵保护逻辑示意图

Figure 1.6 Schematic diagram of failure protection logic

1.5 CT 断线监测

1.5 CT monitoring

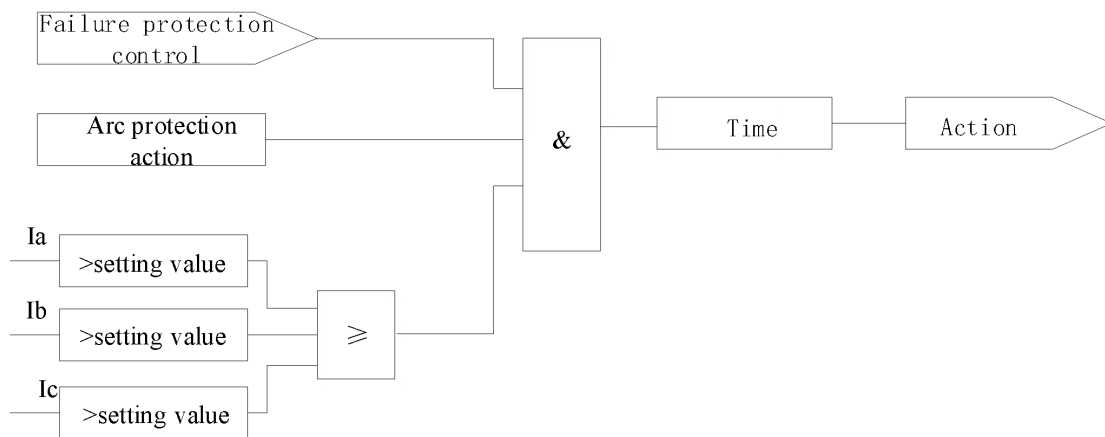
3CT 电流接线方式时，任一相或者两相电流断线，经延时，CT 断线告警动作；2CT 电流接线方式时，任一相电流断线，经延时，CT 断线告警动作。

When using the 3CT current connection method, if any phase or two phases of the current are disconnected, after a delay, the CT disconnection alarm will activate; When using the 2CT current wiring method, if any phase current is disconnected and delayed, the CT disconnection alarm will activate.



图 1.7 CT 断线告警逻辑示意图

Figure 1.7 Schematic diagram of CT disconnection alarm logic

1.6 非电量保护

1.6 Non-electric quantity protection

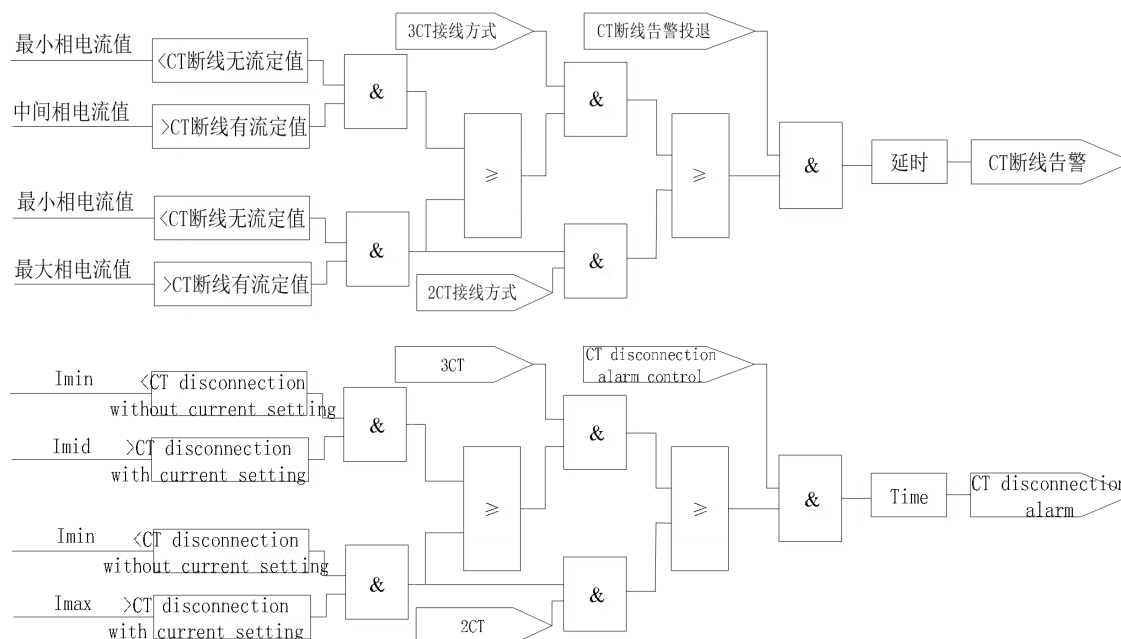
非电量保护投入，经延时，非电量保护动作。

Non-electric quantity protection is activated, and after a delay, the non electric quantity protection is activated.



图 1.8 非电量保护逻辑示意图

Figure 1.8 Schematic diagram of non-electric protection logic

1.7 装置异常自检

1.7 Device Abnormal Self Test

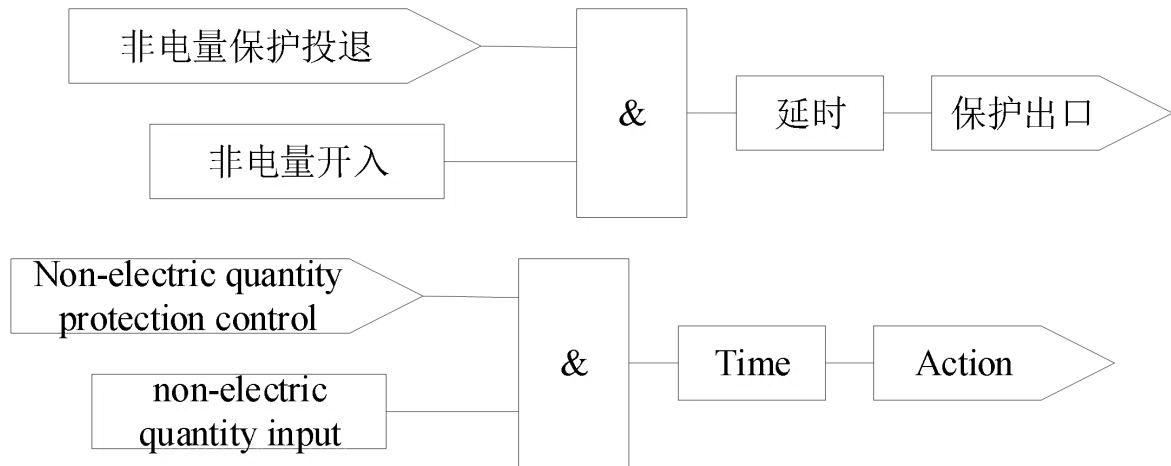
当装置失电或装置内部故障时，装置发出告警信号，同时装置的异常指示灯亮。

When the device loses power or has internal faults, the device sends an alarm signal and the abnormal indicator light of the device lights up.

1.8 检修状态闭锁

1.8 Maintenance status locking

外部开入（检修状态）可独立选择闭锁动作出口或通讯传输。若投入“检修状态闭锁出口”，则此时保护跳闸时，仅产生事件记录，装置出口不动作；若投入“检修状态闭锁通讯”，则此时无法通讯，但保护功能可正常动作。

External input (maintenance status) can independently select the locking action outlet or communication transmission. If the "maintenance status locking outlet" is activated, only event records will be generated when the protection trips, and the device outlet will not act; If "maintenance status locking communication" is activated, communication cannot be achieved at this time, but the protection function can operate normally.



图 1.9 检修状态闭锁逻辑示意图

Figure 1.9 Maintenance Status Lockout Logic Diagram

2 参数表

2 Parameter Table

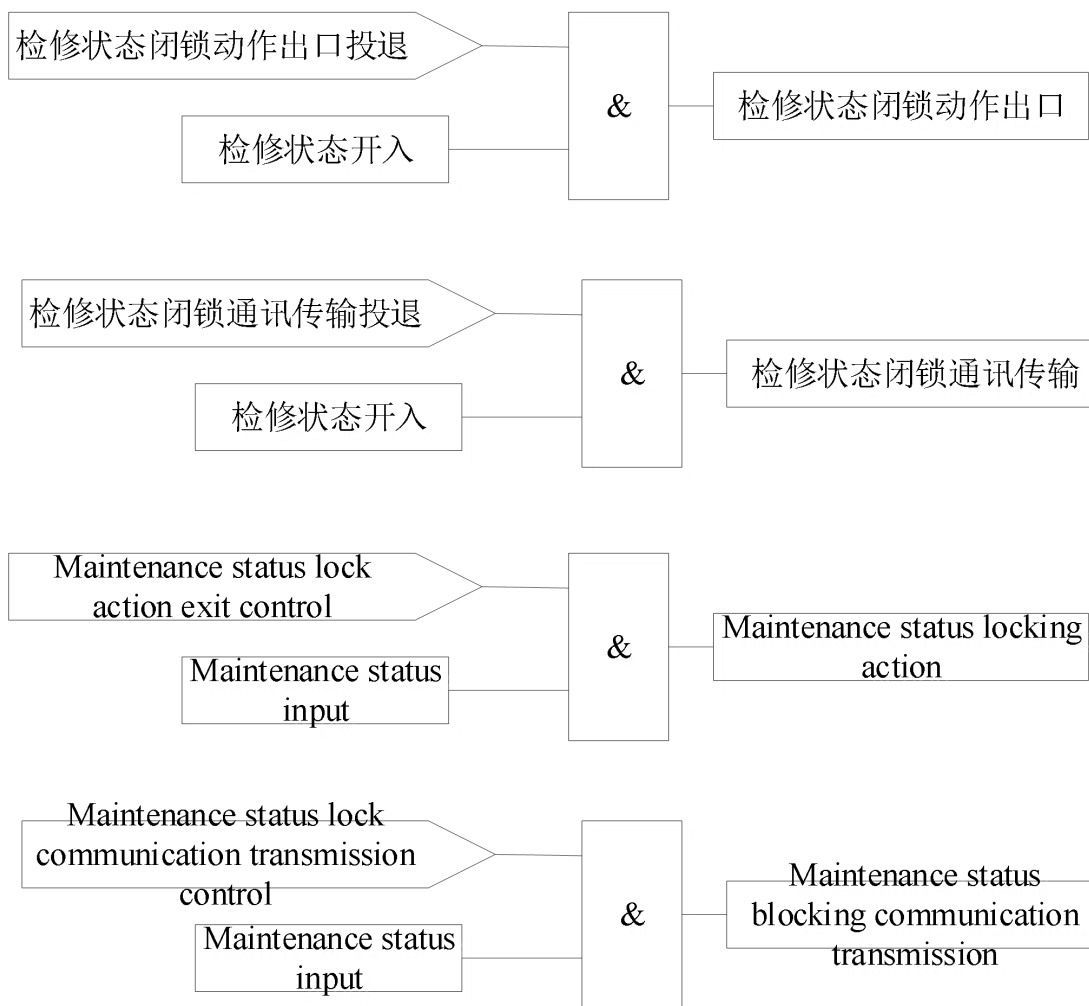
2.1 定值设置表

2.1 Fixed value setting table

表 2.1 ARB6 定值设置表

Table 2.1 ARB6 Setting Table

ARB6 定值设置				
ARB6 constant value setting				
序号 No.	保护名称 Protection Function	定值名称 Value Name	默认值 Default	备注 Notice
1		1#电流接线方式	3CT	3CT; 2CT

		1#I Mode		
2		2#电流接线方式 2#I Mode	3CT	3CT; 2CT
3		3#电流接线方式 3#I Mode	3CT	3CT; 2CT
4		4#电流接线方式 4#I Mode	3CT	3CT; 2CT
5		额定二次电流 (Ie)	5A	0.001A~200A
6		额定二次电压 (Ue)	100V	0.001V~400V
7	第 1 组 弧光保护 Group 1 Arc protection	第 1 组弧光保护投退 1K	退出 OFF	退出; 投入 OFF; ON
8		第 1 组弧光保护判据 1Crit	弧光与电流 (Arc & Current)	弧光 (Arc); 弧光与电流 (Arc & Current); 弧光与电压 (Arc & Voltage)
9		1 组弧光保护延时 1Arc.T	0s	0s~9999.999s
10		1 组电流定值 1I	1.2Ie	额定二次电流的倍数 (0.001~200) Ie
11		1 组电流通道映射 1IM	000000000000	12 路电流通道 (从左往右); 所在位为 1: 关联该电流。 12 current channels (from left to right); Position 1: Associate with the current.
12		1 组零序电压定值 1U0	0.4Ue	额定二次电压的倍数 (0.001~200) Ue
13		1 组电压通道映射 1UM	000	3 路电压通道; 所在位为 1: 关联该电压。 3 voltage channels; Position 1: Associate with the voltage.
14		1 组光强定值 1ARC	10klx	0klx~50klx

15		1 组传感器映射(1-15) 1M1	0000000000000000	第 1-15 号传感器（从左往右）；所在位为 1：关联该传感器。 Sensors 1-15 (from left to right); Position 1: Associate the sensor.	
16		1 组传感器映射(16-30) 1M2	0000000000000000	第 16-30 号传感器（从左往右）；所在位为 1：关联该传感器。 Sensors 16-30 (from left to right); Position 1: Associate the sensor.	
17		1 组出口映射 1DO	0000000000000000	16 路继电器出口（从左往右）；所在位为 1：关联该出口。 16 relay outlets (from left to right); Position 1: Associate with the DO.	
18	第 2 组~第 16 组 ● 弧光保护 ● Group 2-16 ● Arc protection				
182					
183		第 1 组 失灵保护 Group 1 Failure protection	1 组失灵保护投退 E.1SL	退出 OFF	退出；投入 OFF; ON
184			1 组失灵保护电流定值 1SI	2Ie	额定二次电流的倍数 (0.001~200) Ie
185	1 组失灵电流通道映射 1IM		000000000000	12 路电流通道（从左往右）；所在位为 1：关联该电流。 12 current channels (from left to right); Position 1: Associate with the current.	
186	1 组失灵保护延时 1SL.T		0s	0s~9999.999s	

187		1 组失灵保护出口映射 1SD	0000000000000000	16 路继电器出口（从左往右）；所在位为 1：关联该出口。 16 relay outlets (from left to right); Position 1: Associate with the DO.
188	第 2 组~第 4 组			
●	失灵保护			
●	Group 2-4			
●	Failure			
202	protection			
203	弧光传感器 光强事件记录	传感器光强记录 E.Arc.E	退出 OFF	退出；投入 OFF; ON
204	arc sensor Light intensity event recording	传感器光强值 Arc.E.S	10klx	0klx~50klx
205	第 1 组 非电量保护	非电量 1 投退 E.Non-el1	退出 OFF	退出；投入 OFF; ON
206		非电量 1 延时 Non-el1.T	1s	0s~9999.999s
207	Group 1 non-electric quantity protection	非电量 1 出口映射 El.D	0000000000000000	16 路继电器出口（从左往右）；所在位为 1：关联该出口。 16 relay outlets (from left to right); Position 1: Associate with the DO.
208	第 2 组~第 4 组			
●	非电量保护			
●	Group 2-4			
●	non-electric			
216	quantity protection			
217	CT 断线告警 CT	CT 断线投退 E.CTBr.A	退出 OFF	退出；投入 OFF; ON
218	disconnection	CT 断线无流定值	0.125A	0.04A~100A

	alarm	CTBr.I.N		
219		CT 断线有流定值 CTBr.I.S	0.2A	0.04A~100A
220		CT 断线延时 CTBr.T	5s	0s~9999.999s
221		CT 断线出口映射 CTBr.D	0000000000000000	16 路继电器出口（从左往右）；所在位为 1：关联该出口。 16 relay outlets (from left to right); Position 1: Associate with the DO.
222	检修状态闭锁 Maintenance status lock	检修闭锁通讯投退 E.M.BC	退出 OFF	退出；投入 OFF; ON
223		检修闭锁出口投退 E.M.BE	退出 OFF	退出；投入 OFF; ON
224		链路异常出口映射 link.D	0000000000000000	16 路继电器出口（从左往右）；所在位为 1：关联该出口。 16 relay outlets (from left to right); Position 1: Associate with the DO.
225		装置失电出口映射 PpwerD	0000000000000001	16 路继电器出口（从左往右）；所在位为 1：关联该出口。 16 relay outlets (from left to right); Position 1: Associate with the DO.
226		保护动作信号出口映射 S2	0000000000000000	16 路继电器出口（从左往右）；所在位为 1：关联该出口。 16 relay outlets (from left to right); Position 1: Associate with the DO.
227		断路器动作延时 Cir.Br.T	20ms	20ms~10000ms

228		过量返回系数 Excess R.C	0.95	0.001~1.000
229		欠量返回系数 Under R.C	1.05	1.000~2.000

2.2 软压板设置表

2.2 Soft pressing plate setting table

装置可独立控制每个弧光采集端口。当弧光传感器光纤接入弧光采集端口时，需“投入”相应传感器的监测使能软压板。只有“投入”监测使能软压板的弧光传感器，其光强值才能被监测，并且其对应的传感器及光纤实时自检功能才会开启。当弧光采集端口没有接入光纤时，须“退出”对应的监测使能软压板，否则装置会报告该传感器链路自检异常。

The device can independently control each arc acquisition port. When the optical fiber of the arc sensor is connected to the arc acquisition port, the corresponding sensor's monitoring and enabling soft pressing plate needs to be "put into operation". Only the arc sensor that enables the soft pressing plate to be monitored can its light intensity value be monitored, and its corresponding sensor and fiber real-time self check function will be activated. When the arc collection port is not connected to the fiber optic cable, the corresponding monitoring enable soft pressing plate must be "exited", otherwise the device will report an abnormal self check of the sensor link.

表 2.2 ARB6 软压板设置表

Table 2.2 ARB6 Soft Pressing Plate Setting Table

ARB6 软压板 ARB6 soft pressing plate		
序号 No.	软压板名称 Soft pressing plate name	备注 Notice
1	传感器 1 监测使能 ARC1.E	接入光纤的，须投入相应的传感器使能； 没接入光纤的，须退出相应的传感器使能。 切记：不能多投，也不能少投！ For fiber optic connections, corresponding sensors must be installed to enable them; If there is no fiber optic connection, the corresponding sensor must be disabled. Remember: You cannot throw too much or too little!
●	●	
●	●	
●	●	
30	传感器 30 监测使能 ARC30.E	
31	闭锁传感器 1 自检	退出：传感器及链路自检

	L1.B	投入：传感器及链路不自检
●	●	Exit: Sensor and Link Self Test
●	●	Input: Sensor and link not self checking
●	●	
60	闭锁传感器 30 自检 L30.B	

3 背板端子定义和二次原理图

3 Backboard terminal definition and secondary schematic diagram

3.1 背板端子定义图

3.1 Backboard terminal definition diagram

ARB6 系列弧光保护装置背板端子，包括交流输入量端子、开出端子、弧光采集端子、通信端子、开入量端子和装置电源端子。

The ARB6 series arc protection device backplane terminals include AC input terminals, output terminals, arc acquisition terminals, communication terminals, input terminals, and device power terminals.

X1 端子为交流输入量端子。X1.1—X1.24 为 12 路保护电流接入端子，X1.25—X1.30 为三路零序电压接入端子。

The X1 terminal is an AC input terminal. X1.1-X1.24 are 12 protection current connection terminals, and X1.25-X1.30 are three zero sequence voltage connection terminals.

X2 端子为通信端子，共有 2 路 RS485 通信端子和一路 IRIG-B 对时输入端子。X2.1、X2.2、X2.3 为第一路通信端子，X2.6、X2.7、X2.8 为第二路通信端子，两路通信均支持 IEC60870-5-103 和 Modbus-RTU 通讯规约。

The X2 terminal is a communication terminal, consisting of two RS485 communication terminals and one IRIG-B timing input terminal. X2.1, X2.2, and X2.3 are the first communication terminals, while X2.6, X2.7, and X2.8 are the second communication terminals. Both communication channels support IEC60870-5-103 and Modbus RTU communication protocols.

X4 端子为装置电源端子，X4.4 为装置电源保护地，必须可靠连接大地。

The X4 terminal is the device power terminal, and X4.4 is the device power protection ground, which must be reliably connected to the ground.

X5 端子为开关量输入端子。ARB6 弧光保护装置全系列标配 5 路开入量（X5.1—X5.7，X5.7 为公共端），其中 ARB6-A12 和 ARB6-A24 支持扩展到 22 路开入（标配 X5.1—X5.7，扩展 X5.8—X5.24，X5.7 和 X5.24 为公共端）。同公共端的开入必须有相同的极性。开入须外接电压 AC/DC 220V、AC/DC110V、DC48V 或 DC24V，所接电压等级需在订货前注明。

The X5 terminal is the switch input terminal. The ARB6 arc protection device comes

standard with 5 inputs (X5.1-X5.7, X5.7 is the common end), among which ARB6-A12 and ARB6-A24 support extension to 22 inputs (X5.1-X5.7, X5.8-X5.24, X5.7 and X5.24 are the common end). The input to the same common terminal must have the same polarity. The input voltage must be externally connected to AC/DC 220V, AC/DC110V, DC48V or DC24V, and the voltage level to be connected must be specified before ordering.

X6 端子为开关量输出端子，共有 16 组无源继电器输出接点，其中 DO1—DO14 为常开接点，DO15—DO16 为常闭接点。16 组开关量输出的具体定义可以通过装置的“出口映射”菜单界面查看。

The X6 terminal is the switch output terminal, with a total of 16 sets of passive relay output contacts, of which DO1-DO14 are normally open contacts and DO15-DO16 are normally closed contacts. The specific definition of 16 sets of switch outputs can be viewed through the "Exit Mapping" menu interface of the device.

X8 端子为弧光传感器的光纤接入端子。接入顺序为从上到下，从左到右，即左边的弧光采集板先接，同一块弧光采集板从上往下接入弧光传感器光纤。

The X8 terminal is the fiber optic connection terminal of the arc sensor. The connection sequence is from top to bottom, from left to right, that is, the arc acquisition board on the left is connected first, and the same arc acquisition board is connected to the arc sensor fiber from top to bottom.

E1—E3 接口为以太网口，支持 TCP IEC60870-5-103、TCP、Modbus-RTU 规约。

The E1-E3 interface is an Ethernet port that supports TCP IEC60870-5-103, TCP, and Modbus RTU protocols.

USB 接口为装置程序维护口。

The USB interface is the device program maintenance port.



图 3.1 ARB6-A30 背板端子定义图
Figure 3.1 ARB6-A30 Backplane Diagram



图 3.2 ARB6-A24 背板端子定义图

Figure 3.2 ARB6-A24 Backplane Diagram

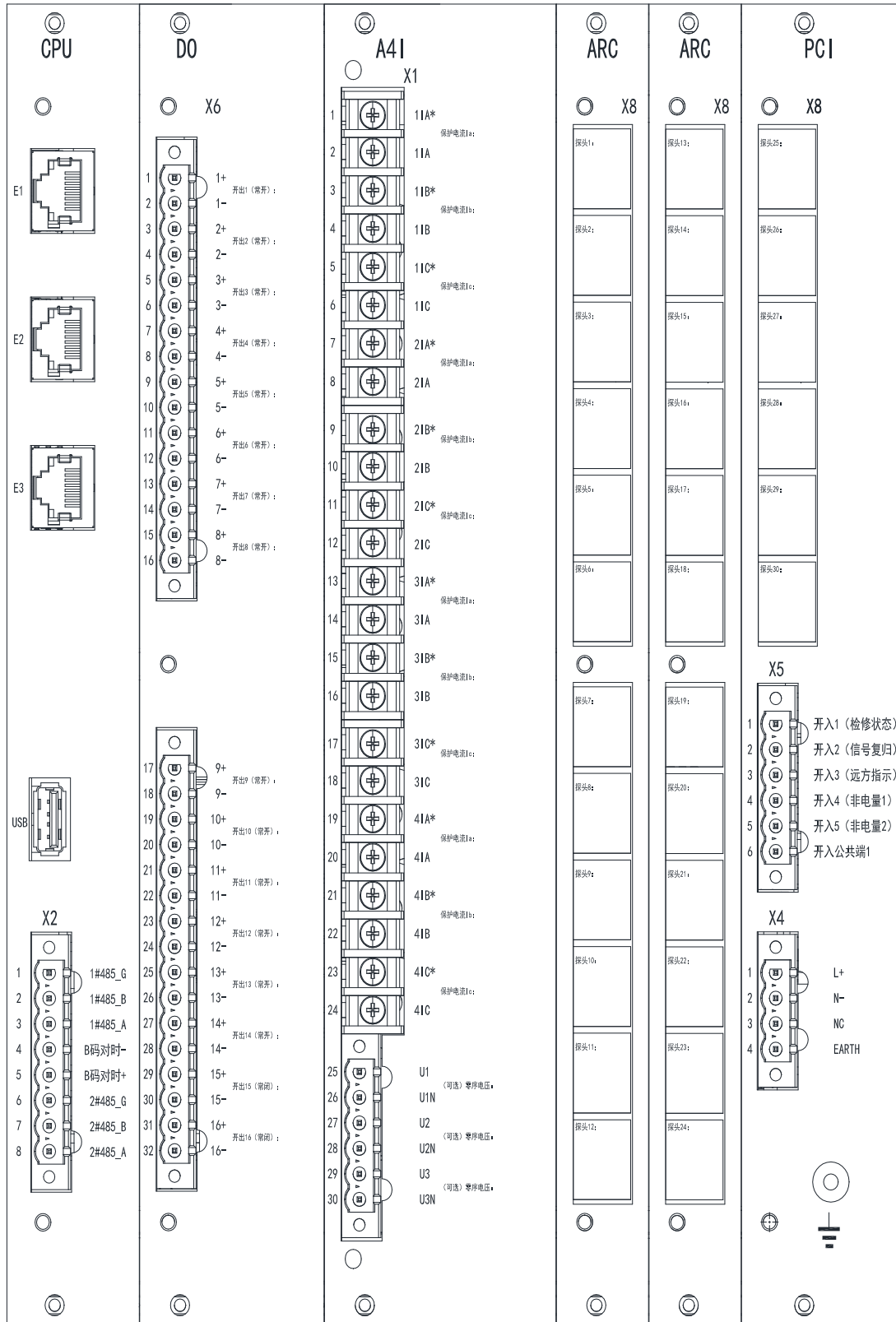

图 3.3 ARB6-A18 背板端子定义图

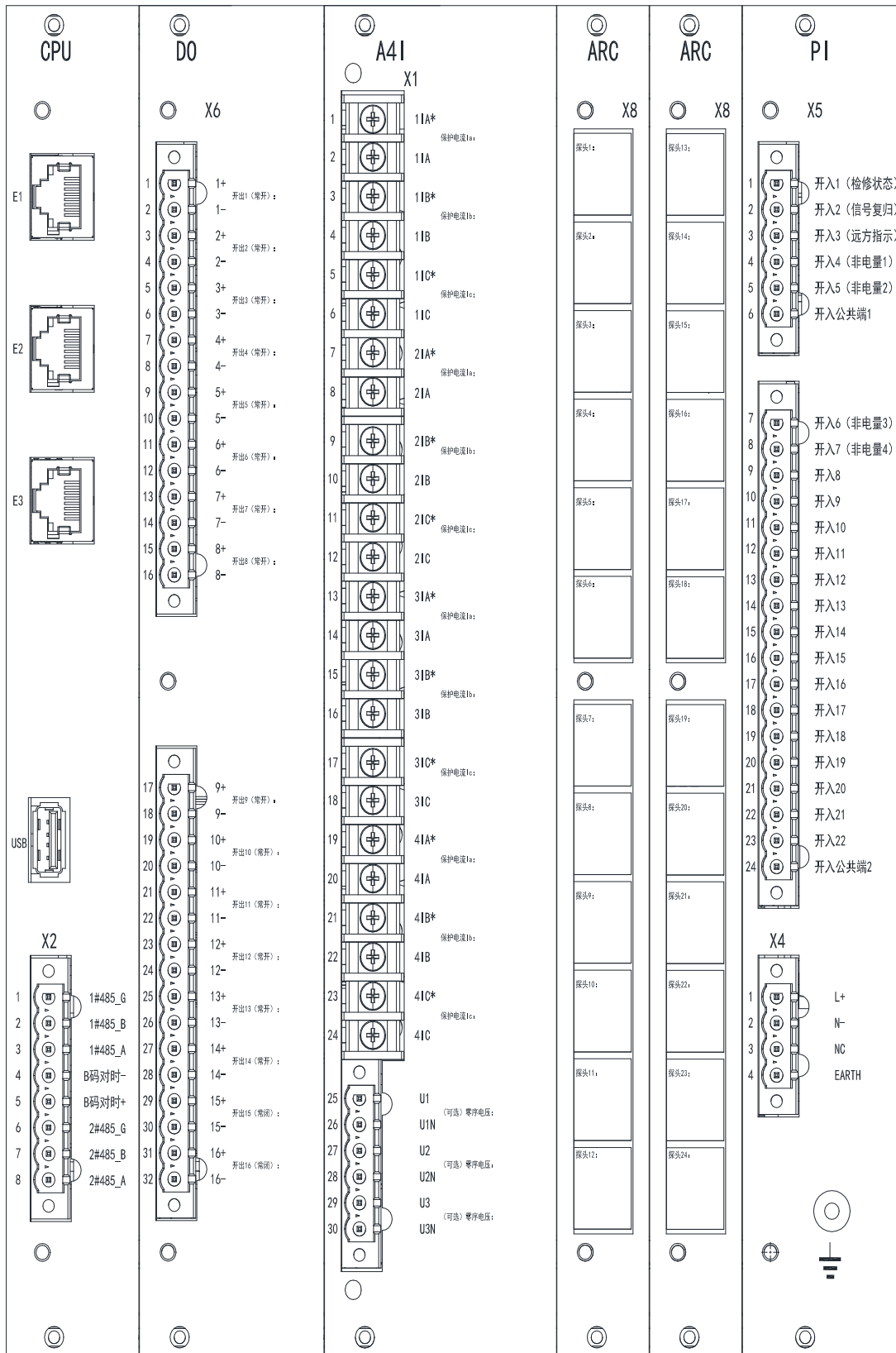
Figure 3.3 ARB6-A18 Backplane Diagram



图 3.4 ARB6-A12 背板端子定义图
 Figure 3.4 ARB6-A12 Backplane Diagram

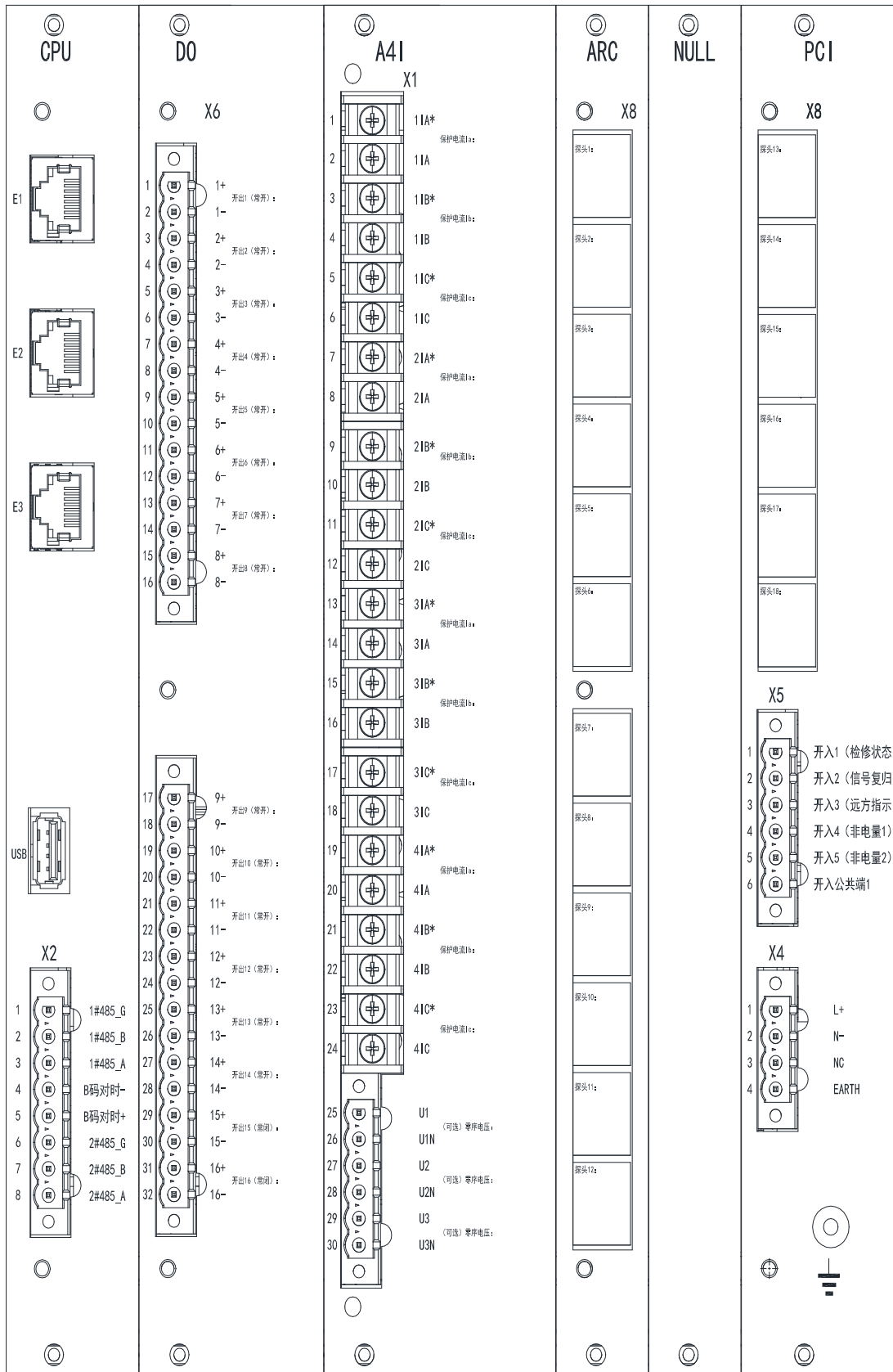

图 3.5 ARB6-A6 背板端子定义图
Figure 3.5 ARB6-A6 Backplane Diagram

3.2 二次原理图

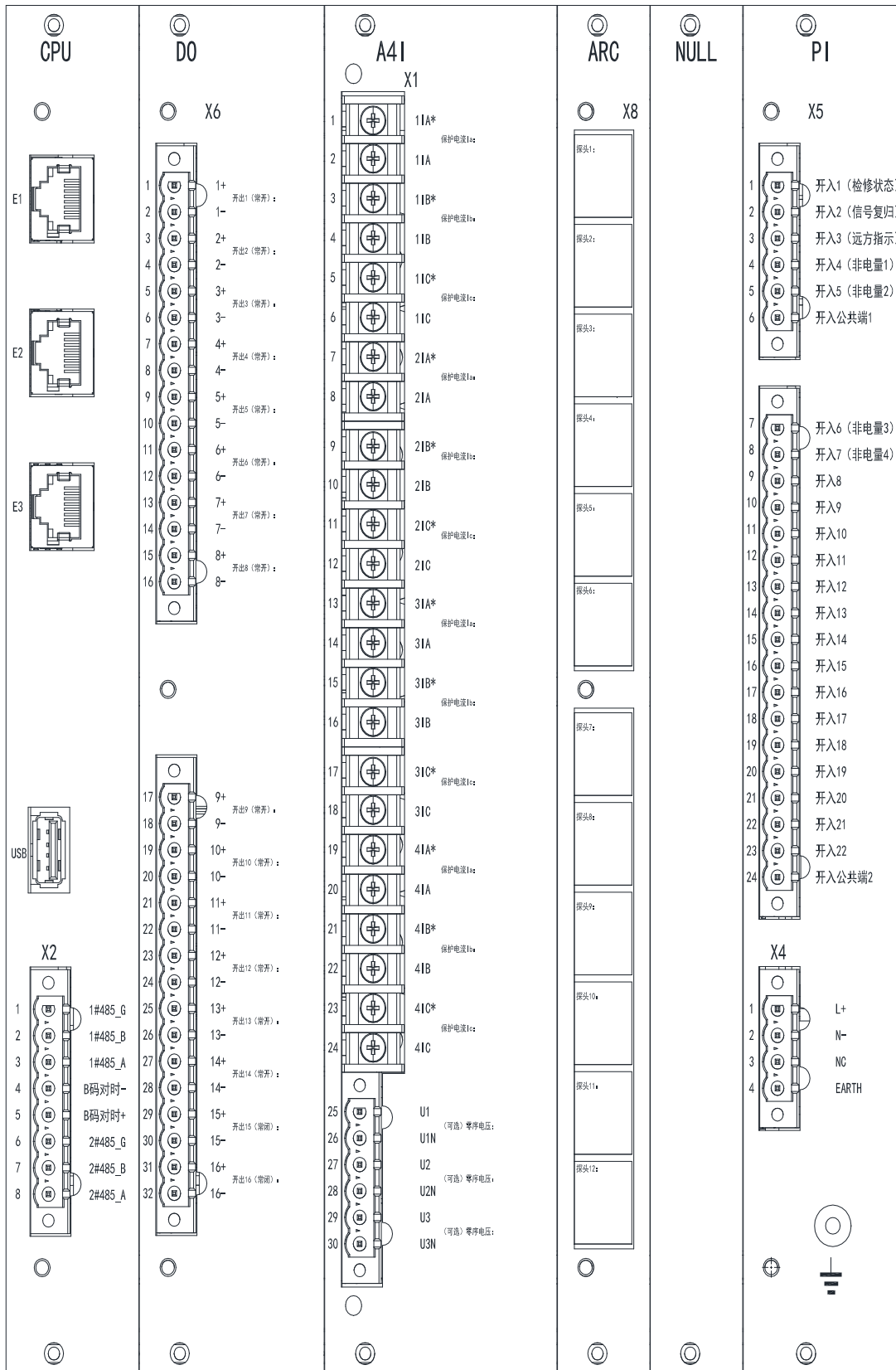
3.2 schematic diagram

ARB6 系列弧光保护装置的二次原理图，如下。

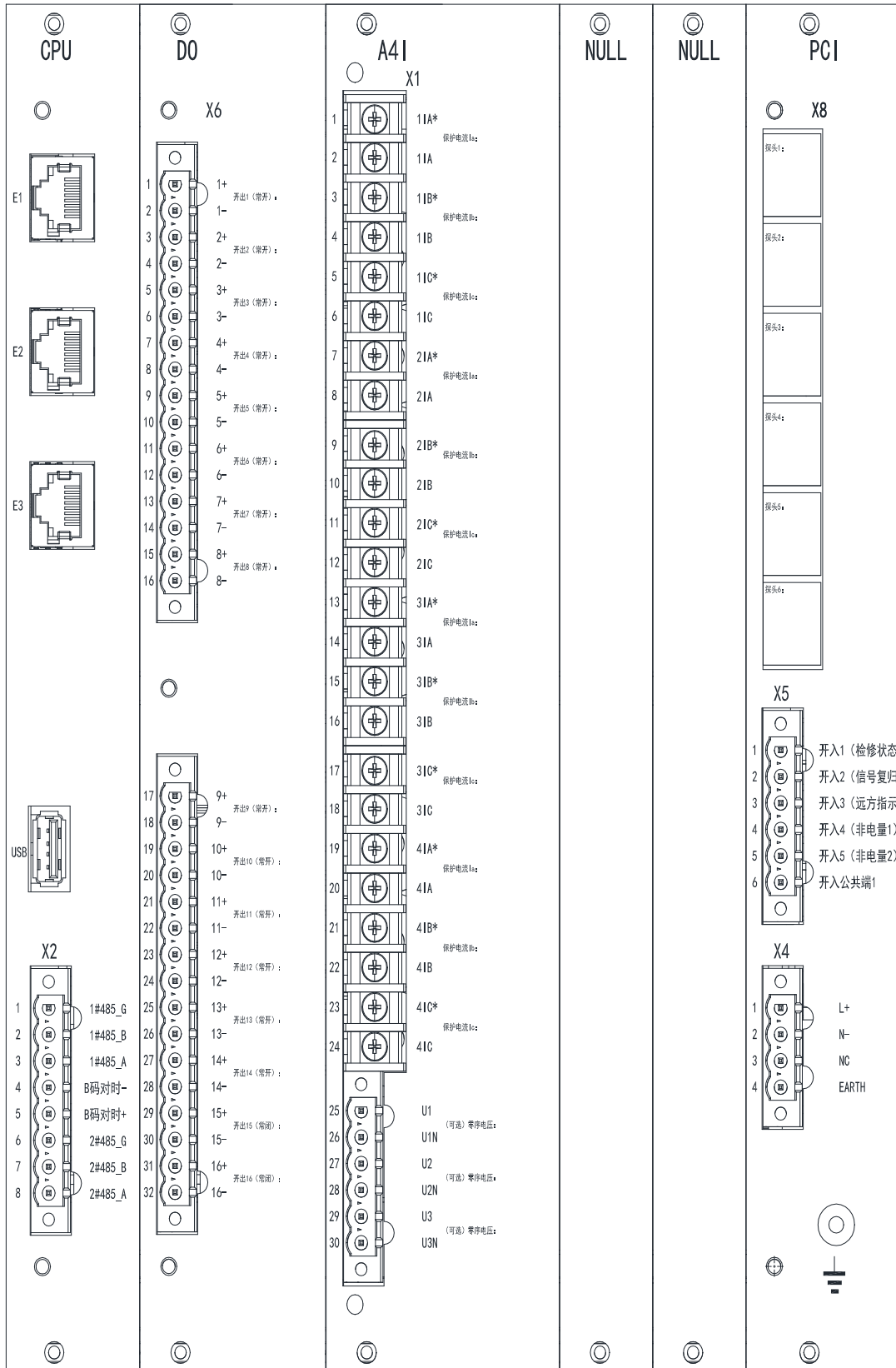
The secondary schematic diagram of the ARB6 series arc protection device is as follows.



图 3.6 电流、电压回路二次原理图

Figure 3.6 Secondary schematic diagram of current and voltage circuits

注：电压回路为选配，请根据项目实际情况选择是否接入电压回路。

Note: The voltage circuit is optional. Please choose whether to connect the voltage circuit according to the actual situation of the project.

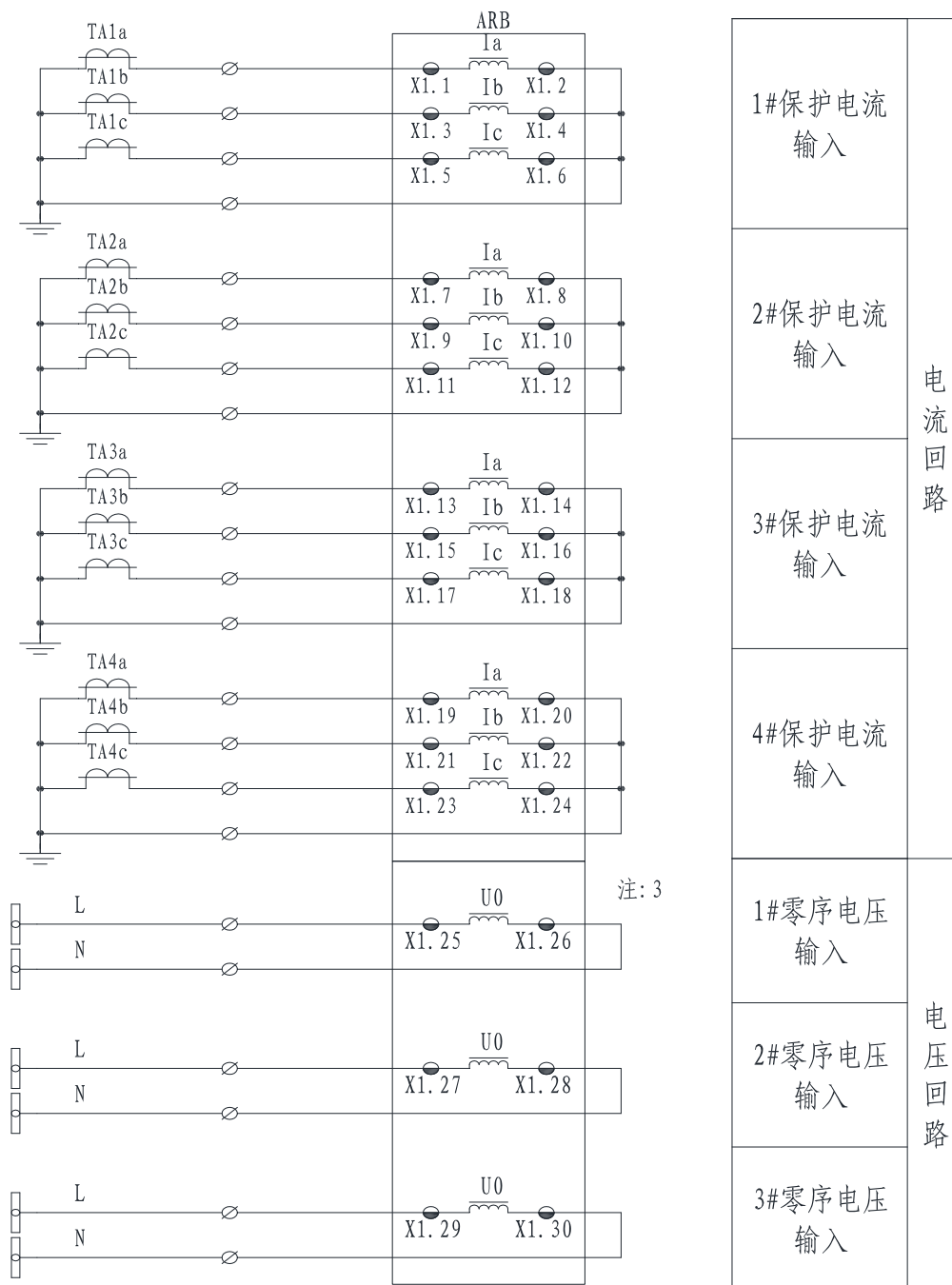

图 3.7 装置电源、开入量回路二次原理图

Figure 3.7 Secondary schematic diagram of device power supply and input circuit

注:

1、保护装置为共地系统，运行前须可靠接地！

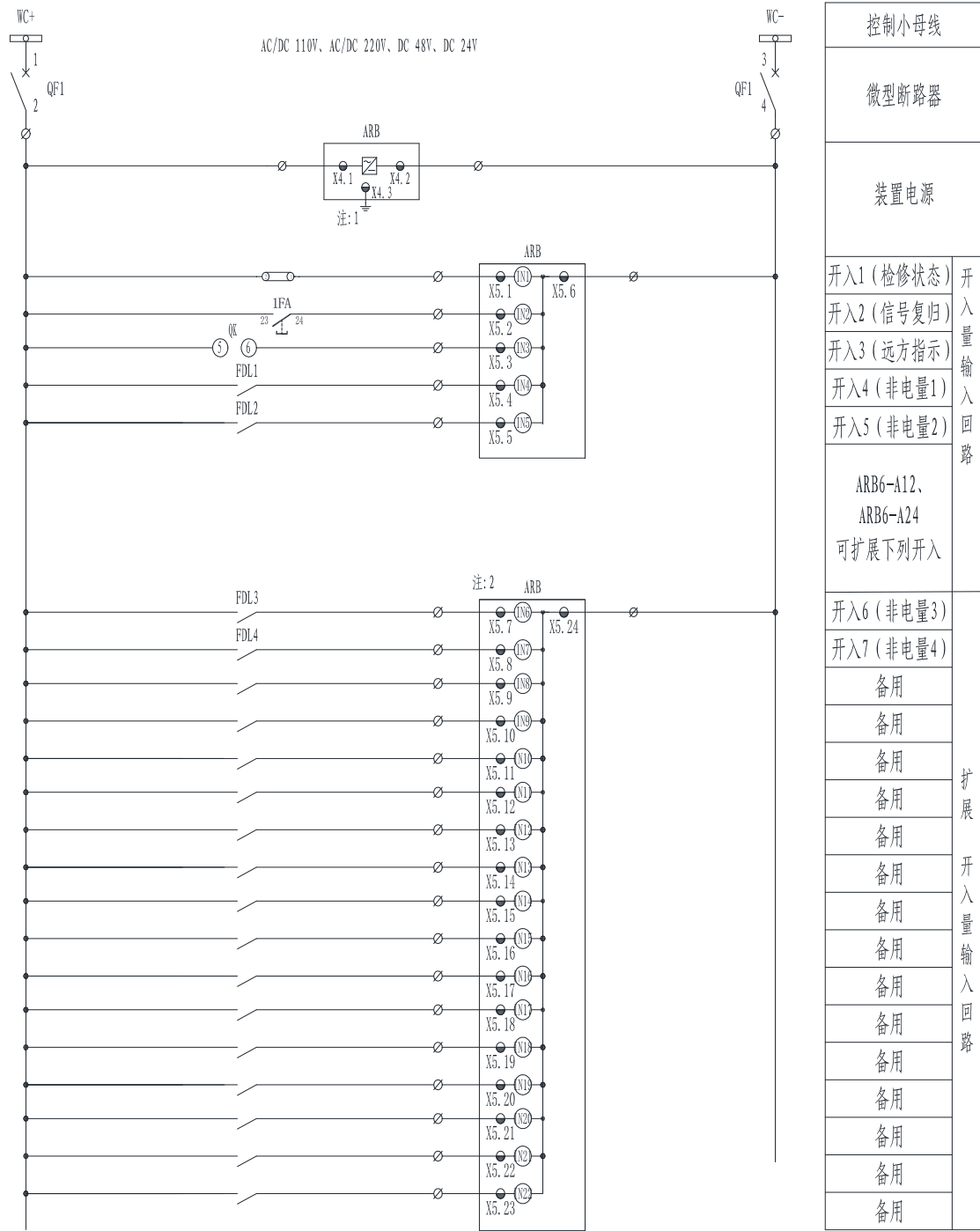
1. The protective device is a common ground system and must be reliably grounded before operation

2、ARB6-A12、ARB6-A24 可扩展开入量，ARB6-A6、ARB6-A18、ARB6-A30 不可扩展开入量。

2. ARB6-A12 and ARB6-A24 are expandable inputs, while ARB6-A6, ARB6-A18, and ARB6-A30 are not expandable inputs.



图 3.8 控制回路二次原理图

Figure 3.8 Secondary schematic diagram of control circuit

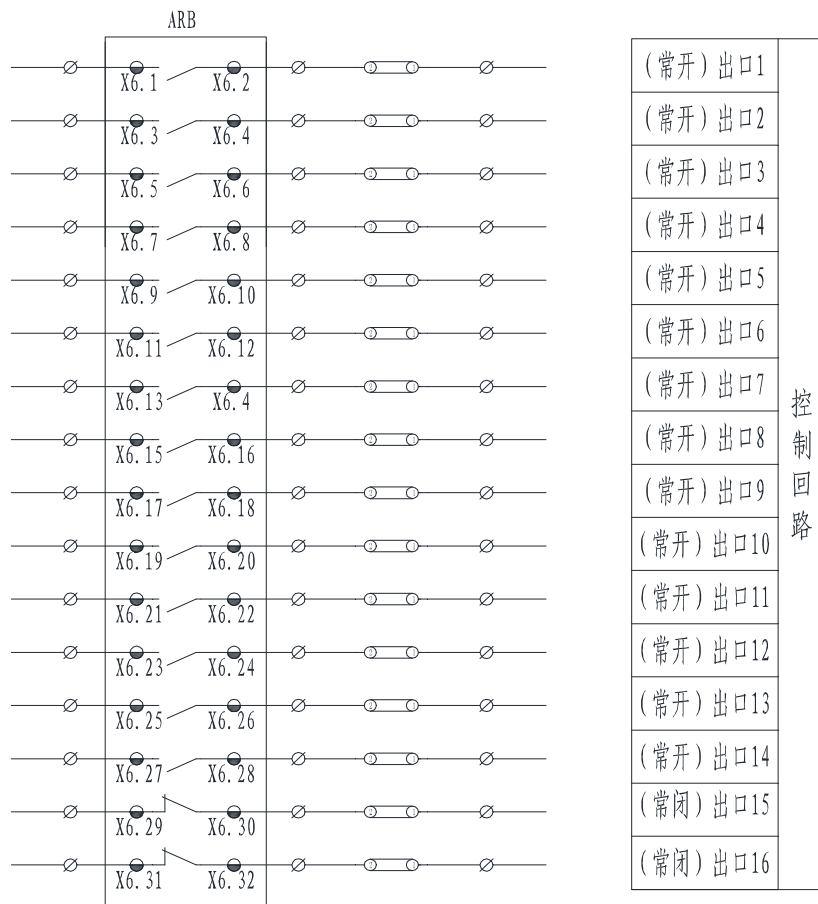

图 3.9 通信接口示意图

Figure 3.9 Communication Interface Diagram

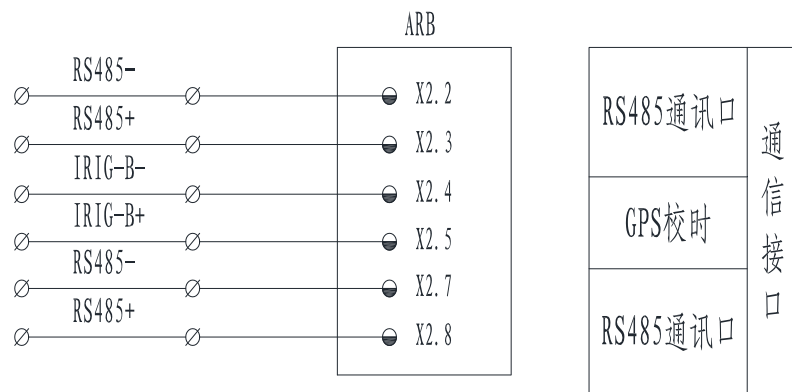

图 3.10 弧光采集接口光纤连接示意图

Figure 3.10 Schematic diagram of fiber optic connection for arc acquisition interface

第三章 典型配置及应用

Chapter 3 Typical Configuration and Application

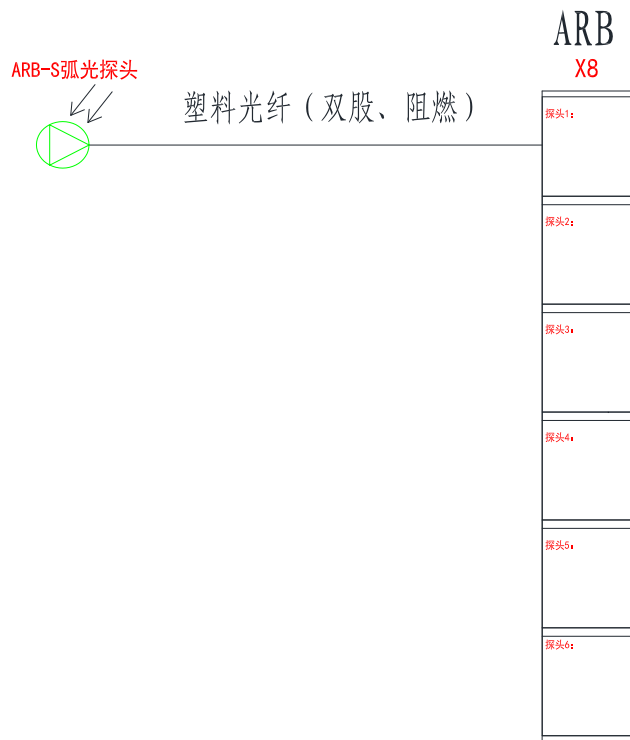
1 母线弧光保护典型配置

1 Typical configuration of busbar arc protection

两进线一联络系统中，每段母线（或者每排开关柜）配置 1 台 ARB6 系列弧光保护装置（可安装在进线柜或 PT 柜），在每面高压柜的母线室（或低压柜的主母排处）配置 1 个 ARB-S 弧光传感器。当需要监测手车室、电缆室等地方的弧光故障时，也可在相应隔室配置弧光传感器。

In the two incoming and one connecting system, each section of the busbar (or each row of switchgear) is equipped with one ARB6 series arc protection device (which can be installed in the incoming cabinet or PT cabinet), and one ARB-S arc sensor is installed in the busbar room of each high-voltage cabinet (or at the main busbar of the low-voltage cabinet). When it is necessary to monitor arc faults in areas such as handcart rooms and cable rooms, arc sensors can also be installed in the corresponding compartments.



图 1.1 ARB6 母线弧光保护典型配置图

Figure 1.1 Typical Configuration of ARB6 Bus Arc Protection

2 保护逻辑及参数设置

2. Protection logic and parameter settings

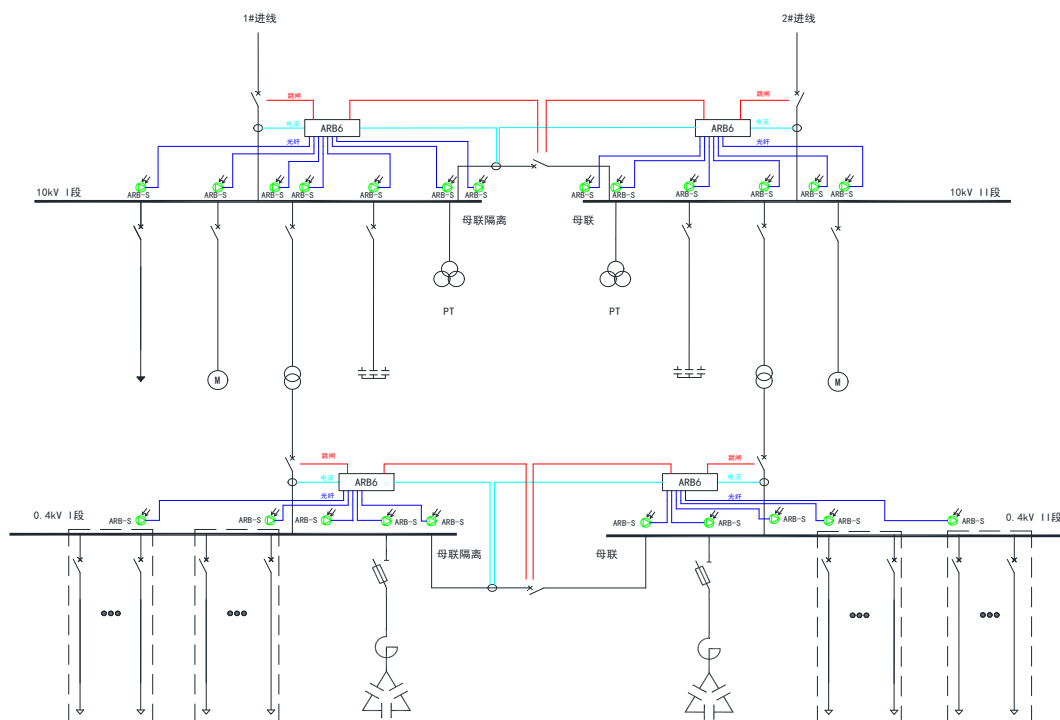
装置可实现不少于 16 组弧光保护逻辑，每组弧光保护逻辑可关联多组弧光、电流或电压值及动作出口。

The device can achieve no less than 16 sets of arc protection logic, and each set of arc protection logic can be associated with multiple sets of arc, current or voltage values, and action outlets.

若多个弧光传感器与其所关联的电流或电压，且动作出口等逻辑量一致，这些弧光传感器可设置为同一组弧光保护逻辑。

If multiple arc sensors are associated with the current or voltage, and the logical quantities of the action outlet are consistent, these arc sensors can be set as the same set of arc protection logic.

(1) 示例一

(1) Example 1

1) 两进线一母联系统，每段母线 10 台开关柜（高压柜或低压柜），呈两排排列。

1) Two incoming lines and one busbar connection system, with 10 switchgear cabinets (high voltage or low voltage cabinets) for each section of the busbar, arranged in two rows.

2) 在每柜的母线室各安装 1 个 ARB-S 弧光传感器，在两台进线柜（空间不够，可在其他柜，如 PT 柜）各安装 1 台 ARB6-A12 弧光保护装置。

2) Install one ARB-S arc sensor in each busbar compartment of each cabinet, and install one ARB6-A12 arc protection device in each of the two incoming cabinets (if space is not sufficient, it can be installed in other cabinets, such as PT cabinets).

3) 每台 ARB6-A12 弧光保护装置接入 10 个弧光传感器（第 1-10 号传感器），弧光+电流（本段进线和母联电流）双判据，动作跳闸本段进线和母联开关。

3) Each ARB6-A12 arc protection device is connected to 10 arc sensors (No. 1-10 sensors), with dual criteria of arc and current (incoming line and busbar current in this section), which trip the incoming line and busbar switch in this section.

4) 若每台 ARB6-A12 弧光保护装置的电流通道 1-3 为本段进线三相电流，电流通道 4-6 为母联三相电流；出口继电器 DO1 跳闸本段进线开关，出口继电器 DO2 跳闸母联开关。背板接线如图 1.2。

4) If the current channels 1-3 of each ARB6-A12 arc protection device are the three-phase current of the incoming line in this section, and the current channels 4-6 are the three-phase current of the busbar; The outlet relay DO1 trips the incoming switch of this section, and the outlet relay DO2 trips the busbar switch. Backboard wiring is shown in Figure 1.2.



图 1.2 示例一背板端子接线示意图
Figure 1.2 Example 1 Backboard Terminal Wiring Diagram

5) 每台 ARB6-A12 弧光保护装置的 10 个弧光传感器构成一组弧光保护逻辑，故只需要投入第 1 组弧光保护，结合定值表和软压板表，两台 ARB6-A12 弧光保护装置参数分别设置如下。

5) Each ARB6-A12 arc protection device consists of 10 arc sensors, forming a set of arc protection logic. Therefore, only the first set of arc protection needs to be activated. Combined with the fixed value table and the soft pressure plate table, the parameters of the two ARB6-A12 arc protection devices are set as follows.

ARB6 定值设置 ARB6 constant value setting				
序号 No.	保护名称 Protection Function	定值名称 Value Name	整定值 Setting	备注 Notice
7	第 1 组 弧光保护 Group 1 Arc protection	第 1 组弧光保护投退 1K	投入 ON	
8		第 1 组弧光保护判据 1Crit	弧光与电流 (Arc & Current)	
9		1 组弧光保护延时 1Arc.T	0s	电力部门出具，或者默认 Issued by the power department, or default
10		1 组电流定值 1I	1.2Ie	电力部门出具，或者默认 Issued by the power department, or default
11		1 组电流通道映射 1IM	111 111 000 000	关联本段母线的进线和 母联电流 Associate the incoming current of this section of the busbar with the bus tie current
12		1 组零序电压定值 1U0	0.4Ue	不涉及，不需修改 No involvement, no modification required
13		1 组电压通道映射 1UM	000	不涉及，不需修改 No involvement, no modification required
14		1 组光强定值	10klx	电力部门出具，或者默认

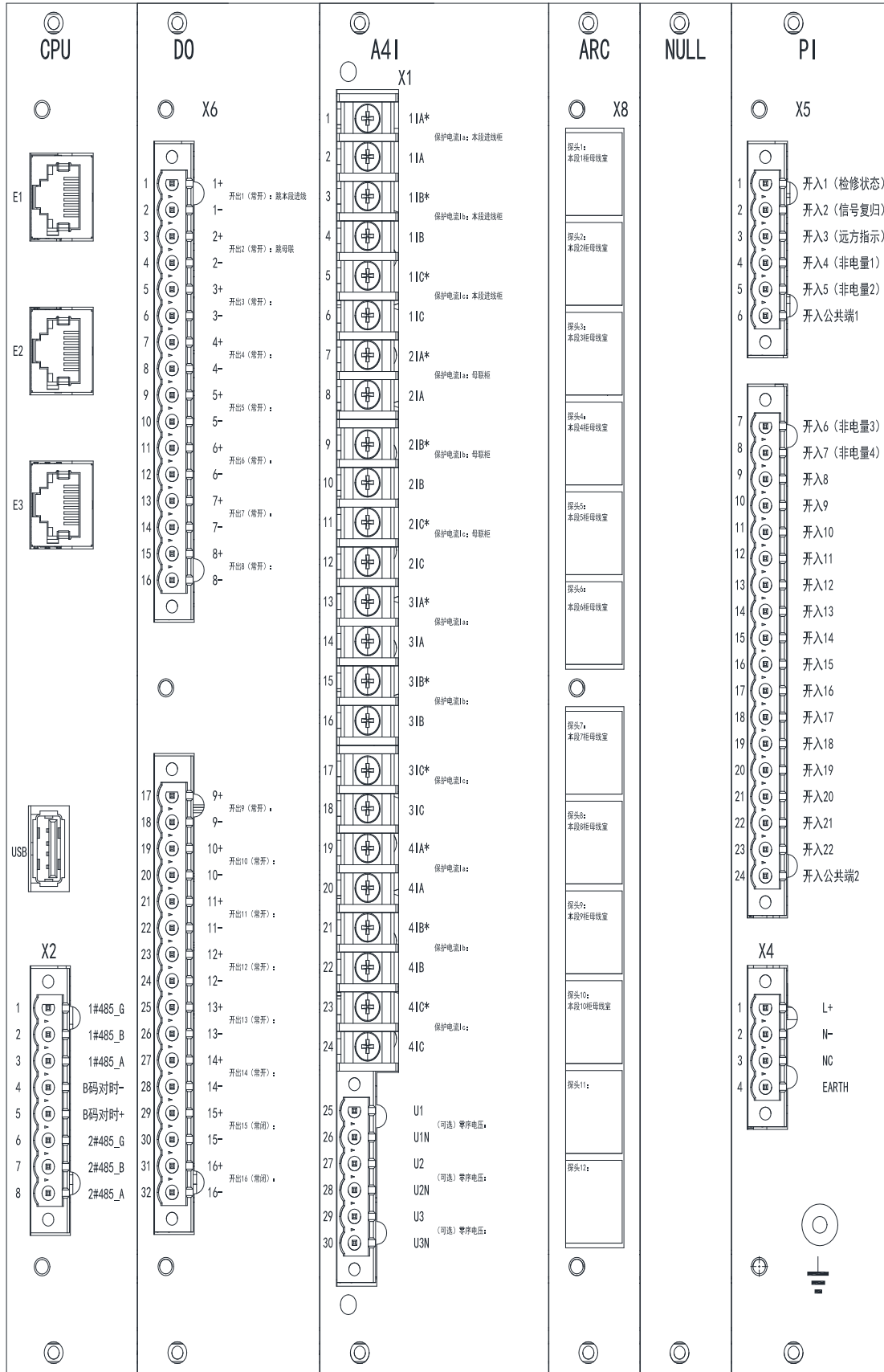
		1ARC		Issued by the power department, or default
15		1 组传感器映射(1-15) 1M1	11111 11111 00000	关联第 1-10 号传感器 Associate sensors 1-10
16		1 组传感器映射(16-30) 1M2	00000 00000 00000	全为 0, 不需关联 All are 0, no association required
17		1 组出口映射 1DO	11000 00000 00000 0	DO1 跳闸本段进线开关, DO2 跳闸母联开关 DO1 trips the incoming switch of this section, and DO2 trips the busbar switch

ARB6 软压板 ARB6 soft pressing plate		
序号 No.	软压板名称 Soft pressing plate name	备注 Notice
1~10	传感器 1~10 监测使能 Sensors 1-10 monitoring enable	投入 ON
11~30	传感器 11~30 监测使能 Sensors 11-30 monitoring enable	退出 OFF

(2) 示例二

(2) Example 2

1) 两进线一母联系统，每段母线 10 台开关柜（高压柜或低压柜），呈一排排列。

1) Two incoming lines and one busbar connection system, with 10 switchgear cabinets (high voltage or low voltage cabinets) arranged in a row for each section of the busbar.

2) 在每柜的母线室各安装 1 个 ARB-S 弧光传感器，在母联柜（空间不够，可在其他柜，如母联隔离柜）安装 1 台 ARB6-A24 弧光保护装置。

2) Install one ARB-S arc sensor in each busbar compartment of the cabinet, and install one ARB6-A24 arc protection device in the busbar cabinet (if there is not enough space, it can be installed in other cabinets, such as busbar isolation cabinet).

3) ARB6-A24 弧光保护装置接入 20 个弧光传感器，其中 I 段母线的 10 个传感器（第 1-10 号传感器），弧光+电流（I 段进线/母联电流）双判据，动作跳闸 I 段进线和母联开关；II 段母线的 10 个传感器（第 11-20 号传感器），弧光+电流（II 段进线/母联电流）双判据，

动作跳闸 II 段进线和母联开关。

3) The ARB6-A24 arc protection device is connected to 20 arc sensors, including 10 sensors (1st to 10th sensors) on the I-section busbar. The arc+current (I-section incoming line/busbar current) dual criterion trips the I-section incoming line and busbar switch; 10 sensors (11th to 20th sensors) on the II section busbar, with dual criteria of arc+current (II section incoming line/busbar current), trip the II section incoming line and busbar switch.

4) 若 ARB6-A24 弧光保护装置的电流通道 1-3 为 I 段进线三相电流，电流通道 4-6 为 II 段进线三相电流，电流通道 7-9 为母联三相电流；出口继电器 DO1 接到 I 段进线开关，出口继电器 DO2 接到 II 段进线开关，出口继电器 DO3 接到母联开关。背板接线如图 1.3。

4) If the current channels 1-3 of the ARB6-A24 arc protection device are the three-phase current of the incoming line in section I, current channels 4-6 are the three-phase current of the incoming line in section II, and current channels 7-9 are the three-phase current of the busbar; The export relay DO1 is connected to the section I incoming switch, the export relay DO2 is connected to the section II incoming switch, and the export relay DO3 is connected to the busbar switch. The backplane wiring is shown in Figure 1.3.



图 1.3 示例二背板端子接线示意图

Figure 1.3 Example 2 Backplane Terminal Wiring Diagram

5) ARB6-A24 弧光保护装置的 20 个弧光传感器构成了两组弧光保护逻辑，故需要投入第 1 组弧光保护和第 2 组弧光保护，结合定值表，该台 ARB6-A24 弧光保护装置参数设置如下。

5) The 20 arc sensors of the ARB6-A24 arc protection device constitute two sets of arc protection logic, so it is necessary to input the first set of arc protection and the second set of arc protection. Combined with the setting table, the parameters of the ARB6-A24 arc protection device are set as follows.

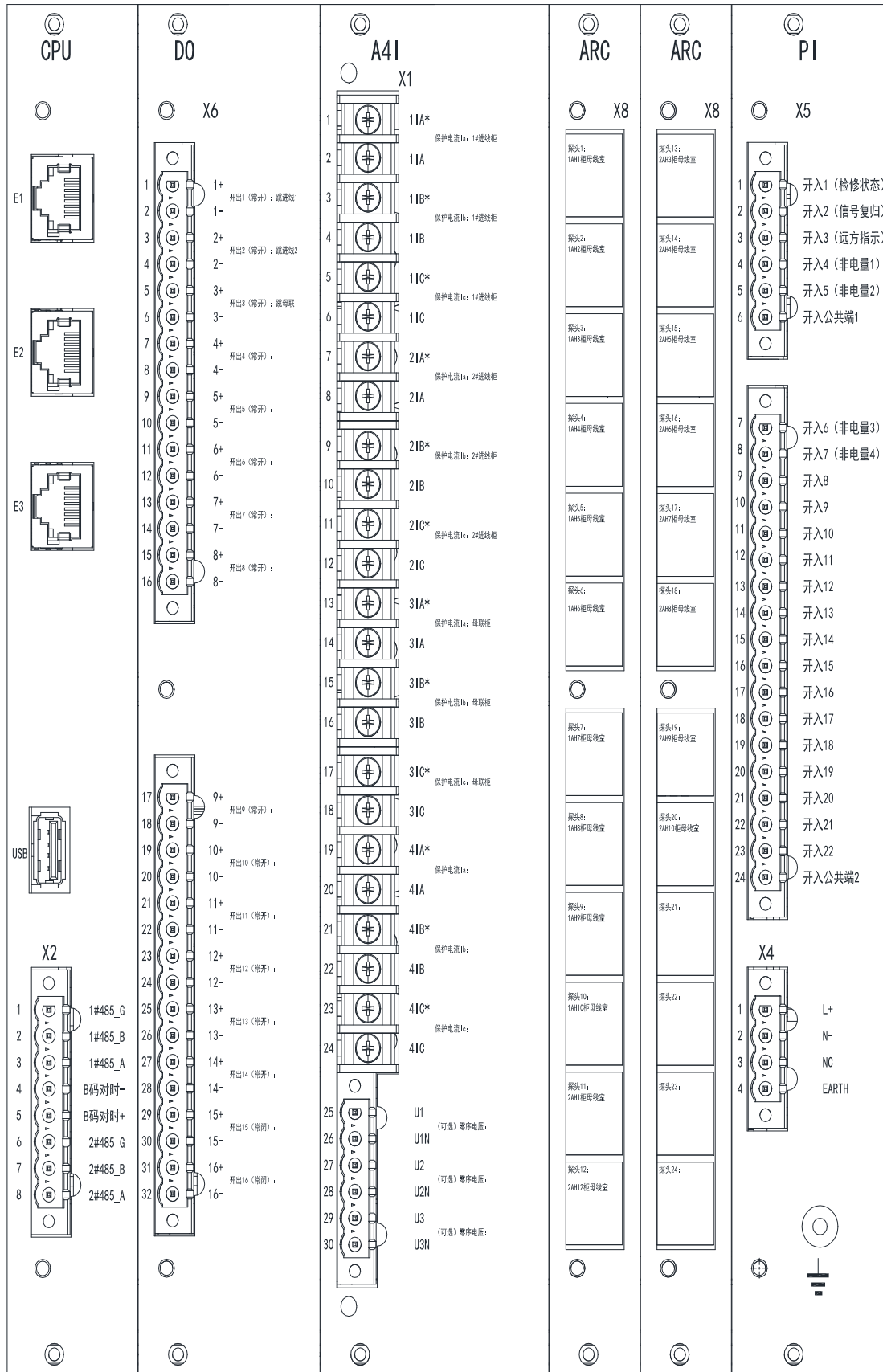
ARB6 定值设置 ARB6 constant value setting				
序号 No.	保护名称 Protection Function	定值名称 Value Name	整定值 Setting	备注 Notice
7	第 1 组 弧光保护 Group 1 Arc protection	第 1 组弧光保护投退 1K	投入 ON	
8		第 1 组弧光保护判据 1Crit	弧光与电流 (Arc & Current)	
9		1 组弧光保护延时 1Arc.T	0s	电力部门出具，或者默认 Issued by the power department, or default
10		1 组电流定值 1I	1.2Ie	电力部门出具，或者默认 Issued by the power department, or default
11		1 组电流通道映射 1IM	111 000 111 000	关联 I 段进线和母联电流 Associate the incoming line of section I with the busbar current
12		1 组零序电压定值 1U0	0.4Ue	不涉及，不需修改 No involvement, no modification required
13		1 组电压通道映射 1UM	000	不涉及，不需修改 No involvement, no modification required
14		1 组光强定值 1ARC	10klx	电力部门出具，或者默认 Issued by the power department, or default

15		1 组传感器映射(1-15) 1M1	11111 11111 00000	关联第 1-10 号传感器 Associate sensors 1-10
16		1 组传感器映射(16-30) 1M2	00000 00000 00000	全为 0, 不需关联 All are 0, no association required
17		1 组出口映射 1DO	10100 00000 00000 0	DO1 跳闸 I 段进线开关, DO3 跳闸母联开关 DO1 trip section I incoming switch, DO3 trip busbar switch
18	第 2 组 弧光保护 Group 2 Arc protection	第 2 组弧光保护投退 2K	投入 ON	
19		第 2 组弧光保护判据 2Crit	弧光与电流 (Arc & Current)	
20		2 组弧光保护延时 2Arc.T	0s	电力部门出具, 或者默认 Issued by the power department, or default
21		2 组电流定值 2I	1.2Ie	电力部门出具, 或者默认 Issued by the power department, or default
22		2 组电流通道映射 2IM	000 111 111 000	关联 II 段进线和母联电流 Associate the incoming line of section II with the busbar current
23		2 组零序电压定值 2U0	0.4Ue	不涉及, 不需修改 No involvement, no modification required
24		2 组电压通道映射 2UM	000	不涉及, 不需修改 No involvement, no modification required
25		2 组光强定值 2ARC	10klx	电力部门出具, 或者默认 Issued by the power department, or default
26			2 组传感器映射(1-15)	00000 00000 11111

		2M1		Associate sensors 11-15
27		2 组传感器映射(16-30)	11111 00000 00000	关联第 16-20 号传感器
		2M2		Associate sensors 16-20
28		2 组出口映射 2DO	01100 00000 00000 0	DO2 跳闸 II 段进开关, DO3 跳闸母联开关 DO2 trip section II incoming switch, DO3 trip busbar switch

ARB6 软压板		
ARB6 soft pressing plate		
序号 No.	软压板名称 Soft pressing plate name	备注 Notice
1~20	传感器 1~20 监测使能 Sensors 1-20 monitoring enable	投入 ON
21~30	传感器 21~30 监测使能 Sensors 21-30 monitoring enable	退出 OFF

3 弧光保护功能调试

3 Arc protection function debugging

在调试过程中，当保护跳闸时，装置面板上“跳闸”指示灯点亮，对应继电器动作出口，液晶上显示相应事件记录信息；当保护告警时，装置面板上“告警”指示灯点亮，对应继电器动作出口，液晶上显示相应事件记录信息。

During the debugging process, when the protection trips, the "trip" indicator light on the device panel lights up, corresponding to the relay action outlet, and the corresponding event record information is displayed on the LCD; When a protection alarm occurs, the "alarm" indicator light on the device panel lights up, corresponding to the relay action outlet, and the corresponding event record information is displayed on the LCD.

依据实际项目一次图和开关柜布局图，合理配置弧光保护装置和弧光传感器，并参考上节“保护逻辑及参数设置”给出的参数设置方法，给装置正确设置参数后，方可进行调试。

Based on the actual project diagram and switchgear layout, configure the arc protection device and arc sensor reasonably, and refer to the parameter setting method provided in the previous section "Protection Logic and Parameter Setting". After setting the parameters correctly for the device, debugging can be carried out.

(1) 弧光单判据

(1) Arc single criterion

1) 使用手持式光标仪或者其他光照强度高的光源模拟发生弧光，给弧光传感器打光。

1) Simulate the occurrence of arc using a handheld cursor or other high intensity light source to illuminate the arc sensor.

2) 在光纤未连接的情况下，可给装置背板的弧光采集板端子打光。

2) When the fiber optic cable is not connected, the arc acquisition board terminals on the device backplane can be illuminated.

(2) 弧光与电流双判据

2) Arc and current dual criteria

1) 依据二次图，给装置施加电流。

1) Apply current to the device according to the quadratic diagram.

2) 使用手持式光标仪或者其他光照强度高的光源模拟发生弧光，给弧光传感器打光。

2) Simulate the occurrence of arc using a handheld cursor or other high intensity light source to illuminate the arc sensor.

3) 在光纤未连接的情况下，可给装置背板的弧光采集板端子打光。

3) When the fiber optic cable is not connected, the arc acquisition board terminals on the device backplane can be illuminated.

(3) 弧光与电压双判据

(3) arc and voltage dual criteria

1) 依据二次图，给装置施加电压。

1) Apply voltage to the device according to the quadratic diagram.

2) 使用手持式光标仪或者其他光照强度高的光源模拟发生弧光，给弧光传感器打光。

2) Simulate the occurrence of arc using a handheld cursor or other high intensity light source to illuminate the arc sensor.

3) 在光纤未连接的情况下，可给装置背板的弧光采集板端子打光。

3) When the fiber optic cable is not connected, the arc acquisition board terminals on the device backplane can be illuminated.

4 维护及常见问题

4 Maintenance and common problems

装置为免维护产品，只要安装运行环境满足要求，正常运行期间不需要日常及定期保养维护。但要留意因长期轻微震动引起的螺丝松动情况。

The device is a maintenance free product, and as long as the installation and operation environment meets the requirements, there is no need for daily or regular maintenance during normal operation. But pay attention to the loosening of screws

caused by long-term slight vibration.

下表是在装置使用过程中可能会遇到的问题及相应处理建议。

The following table shows the problems that may be encountered during the use of the device and corresponding handling suggestions.

表 5.1 问题及相应处理建议

Table 5.1 Problems and corresponding handling suggestions

问题 Problems	可能原因 Possible causes	处理建议 Processing suggestions
Arc sensor link abnormality	1、光纤与装置或传感器未接触好 1. Fiber optic not in good contact with device or sensor 2、光纤未研磨光滑 2. Fiber optic not ground smooth 3、装置背板的传感器采集口未接入传感器（光纤），但投入了该传感器监测使能软压板 3. The sensor acquisition port on the device backplane is not connected to a sensor (fiber optic), but the sensor is used to monitor and enable the soft pressing plate	1、正确插接光纤 1. Correctly plugging in optical fibers 2、重新制作接头并研磨光纤 2. Remake the connector and grind the fiber optic cable 3、退出未连接光纤的传感器监测使能软压板 3. Exit the sensor monitoring enable soft pressing plate without connecting the fiber optic cable
继电器不跳闸 The DO without trip	1、该功能未投入 1. The Enale is exit 2、保护启动条件未达到 2. Protection activation conditions not met 3、出口映射配置错误 3. Export mapping configuration error	1、在定值里投入相应保护 1. Input corresponding protection in the fixed value 2、检查调试方法 2. Check and debug methods 3、在调试菜单进行相应出口配置 3. Configure the corresponding exit in the debugging menu
无通讯 No communication	1、接线极性接反 1. Reverse polarity of wiring 2、通讯参数或规约不一致 2. Inconsistent communication parameters or protocols 3、通讯电缆断线 3. Communication cable disconnection 4、装置地址设置错误 4. Device address setting error	1、调换极性接线 1. Swapping polarity wiring 2、重新设置通讯参数或规约 2. Reset communication parameters or protocols 3、维修或更换通讯电缆 3. Repair or replace communication cables 4、在通讯菜单内设置装置地址 4. Set device address in the communication menu
指示灯显示异常	1、装置为初始化状态	1、请按一次复归键

Abnormal indicator light display	1. Device in initialization state 2、指示灯颜色配置错误 2. Indicator light color configuration error	1. Please press the reset button once 2、在调试菜单配置指示灯颜色 2. Configure indicator light colors in the debugging menu
遥信无显示 Remote communication without display	对应遥信没采到开入信号 Corresponding remote signaling did not receive input signal	检查装置端子和公共端之间电压 Check the voltage between the device terminals and the common terminal

总部：安科瑞电气股份有限公司

Headquarter: Acrel Co., LTD.

地址：上海市嘉定区育绿路 253 号

Address: No.253 Yulv Road Jiading District, Shanghai, China

电话：0086-21-69158338 0086-21-69156052 0086-21-59156392 0086-21-69156971

TEL.: 0086-21-69158338 0086-21-69156052 0086-21-59156392 0086-21-69156971

传真：0086-21-69158303

Fax: 0086-21-69158303

网址：www.acrel-electric.com

Web-site: www.acrel-electric.com

邮箱：ACREL008@vip.163.com

Email: ACREL008@vip.163.com

邮编：201801

Postcode: 201801

生产基地：江苏安科瑞电器制造有限公司

Manufacturer: Jiangsu Acrel Electrical Manufacturing Co., LTD.

地址：江苏省江阴市南闸街道东盟工业园区东盟路 5 号

**Address : No.5 Dongmeng Road,Dongmeng industrial Park, Nanzha Street,Jiangyin
City,Jiangsu Province,China**

电话：0086-510-86179966

TEL: 0086-510-86179966

传真：0086-510-86179975

Fax: 0086-510-86179975

网址：www.jsacrel.com

Web-site: www.jsacrel.com

邮箱：sales@email.acrel.cn

Email: sales@email.acrel.cn

邮编：214405

Postcode: 214405