

030



温湿度控制器

Temperature & Humidity Controller

安装使用说明书 V2.4

Installation and operation instruction V2.4

总部：安科瑞电气股份有限公司

地址：上海市嘉定区育绿路 253 号

电话：(86) 021-69158300 69158301 69158302

传真：(86) 021-69158303

服务热线：800-820-6632

网址：www.acrel.cn

邮箱：ACREL001@vip.163.com

邮编：201801

生产基地：江苏安科瑞电器制造有限公司

地址：江阴市南闸街道东盟路 5 号

电话(传真)：(86) 0510-86179970

邮编：214405

邮箱：JY-ACREL001@vip.163.com

安科瑞电气股份有限公司
ACREL CO.,LTD

申明 DECLARATION

版权所有，未经本公司之书面许可，此手册中任何段落，章节内容均不得被摘抄、拷贝或以任何形式复制、传播，否则一切后果由违者自负。

本公司保留一切法律权利。

No part of this publication may be reproduced, stored in a retrieval system, or transmitted in any form by any means, electronic, mechanical photocopying, recording, or otherwise without prior permission of Acrel. All rights reserved.

本公司保留对本手册所描述之产品规格进行修改的权利，恕不另行通知。
订货前，请垂询当地代理商以获悉本产品的最新规格。

This company reserve power of revision of product specification described in this manual, without notice. Before ordering, please consult local agent for the latest specification of product.

目 录 CONTENTS

前言 Foreword	
1 概述 General	1
2 工作原理 Operational principle	1
一. WH系列普通型温湿度控制器	
WH Series General Controller For Temperatre & Humidity	
1 型号说明 Type explanation	2
2 技术指标 Technical data	3
3 产品规格及功能 Product specification and functions	4
4 接线方式 Wiring	7
二. WHD系列智能型温湿度控制器	
WHD Series Intelligent Temperature & Humidity Controller	
1 型号说明 Type explanation	8
2 技术指标 Technical data	9
3 产品规格及功能 Product specification and functions	10
4 接线方式 Wiring	11
5 产品操作指南 Product operation manual	13
6 通讯指南 Communication manual	20
三. 传感器 Sensor	
1 概述 General	27
2 型号说明 Type explanation	28

前言：温湿度控制器简介

Foreword: Temperature & Humidity Controller Brief introduction

概述 General

温湿度控制器产品主要用于中高压开关柜、端子箱、环网柜、箱变等设备内部温度和湿度的调节控制。可有效防止因低温、高温造成的设备故障以及受潮或结露引起的爬电、闪络事故的发生。产品分为：WH普通型系列、WHD智能型系列。

产品符合国标GB/T15309-1994。

The controller for temperature and humidity is suitable for adjustment and control of temperature and humidity in equipments of high voltage switchgear, terminal box, ring network panel, box transformer substation etc. It can effectively protect relevant equipment from faults resulting from excessive low or high temperature, creepage or flashover etc. from humidity or condensation. Our products may be divided into: WH general series, WHD intelligent series.

These products meet the requirements of GB/T 15309-1994.

工作原理 Operational principle

温湿度控制器主要由传感器、控制器、加热器（或风扇等）三部分组成，其工作原理如下图所示：

The controller for temperature and humidity mainly consists of three parts of transmitter, controller, heater(or fan etc.), its operational principle is shown as following:

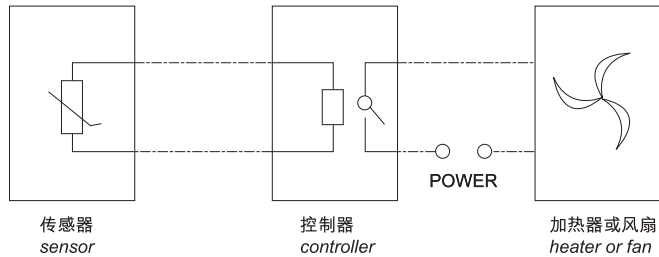

传感器检测箱内温湿度信息，并传递到控制器由控制器分析处理：当箱内的温度、湿度达到或超过预先设定的值时，控制器中的继电器触点闭合，加热器（或风扇）接通电源开始工作，对箱内进行加热或鼓风等；一段时间后，箱内温度或湿度远离设定值，控制器中的继电器触点断开，加热或鼓风停止。除基本功能外不同型号还带有断线报警输出、变送输出、通信、强制加热鼓风等辅助功能。

The message of temperature and humidity in the box is detected by the sensor and analyzed by the controller: When environmental temperature, humidity is up to the presetting value or exceed the presetting value, the controller is giving related signal to contacts of relay, then the heater(or fan) is energized and working to heat or dehumidifying; after environmental temperature, humidity is well below the presetting value, the heater(or fan) is deenergized and stop working. In addition to its basic functions, the specific product with different type possess secondary functions such as alarming output for wire-breaking, communication, forced heating etc.

一. WH系列普通型温湿度控制器

WH General controller for temperature and humidity

1 型号说明 Type explanation

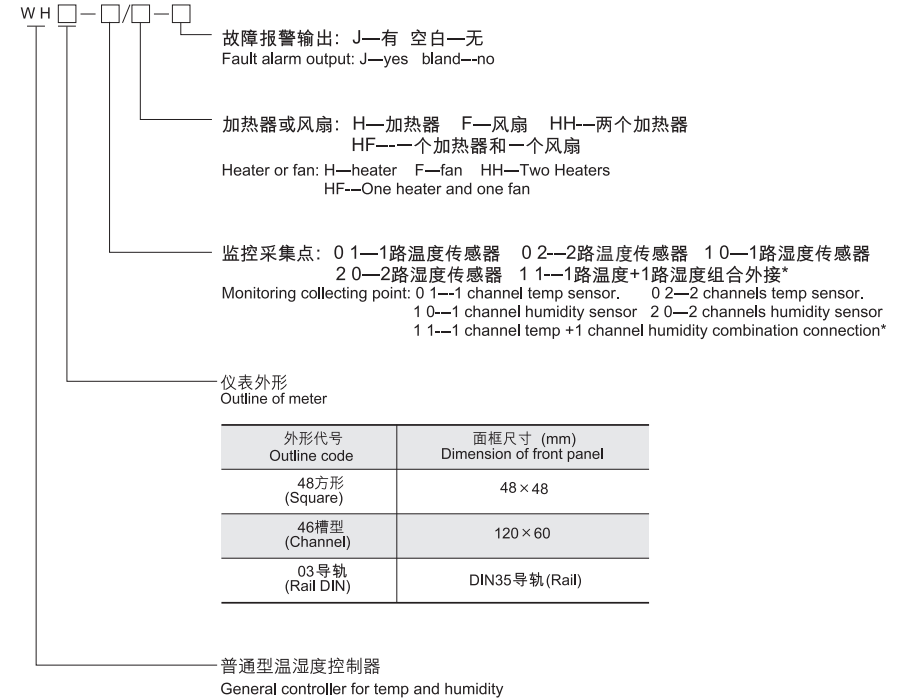

- 注: 1. “组合外接”即同时有温度、湿度控制时，传感器置于同一外壳，由同一点采集温度、湿度信息。
2. 传感器与控制器之间的连接线长度建议不要超过20米。
3. 故障报警输出仅限于WH46型。

1. "connecting combined" say that measuring temperature and humidity at the same time, sensors are built in same shell, collecting temperature message, humidity message at same point.
2. We advise that the connecting wire length between sensor and controller does not exceed 20 m.
3. Only WH46 have fault alarm output.

2 技术指标 Technical data

技术参数 Technical parameters		指标 Value
控制类型及参数 Control mode and parameter	加热升温 Heating for rising temperature	≤5℃启动(Start), ≥13℃停止(Stop) 可由用户指定(May be specified by users)
	鼓风降温 Blowing for decreasing temperature	≥40℃启动(Start), ≤35℃停止(Stop) 可由用户指定(May be specified by users)
	加热去湿 Heating for removing moisture	≥85%启动(Start), ≤77%停止(Stop) 可由用户指定(May be specified by users)
控制精度 Control precision	温度 Temperature	±3℃
	湿度 Humidity	±5%RH
控制触点容量 Control precision		5A/AC250V (无源接点Passive contact)
辅助电源 Auxiliary power	电压 Voltage	AC 85~265V DC 100~350V
	功耗 Consumption	基本功耗(≤1w)+继电器功耗(每路≤0.7w) Basic power consumption(≤1w) + relay power consumption(each channel≤0.7w)
绝缘电阻 Insulation resistance		≥100MΩ
工频耐压 power-frequency withstand voltage		电源与外壳可触及金属件/电源与其它端子组 2kV/1min (AC, RMS) power with shell, touchable metal parts/ power with other terminal group
平均无故障工作时间 average work time without stoppage		≥50000小时(hour)
工作环境 (控制器) working condition (controller)	温度 temperature	-10℃~+55℃
	湿度 humidity	≤95%RH, 不结露, 无腐蚀性气体 without condensation and corrosive gas
	海拔 altitude	≤2500米(m)

注: 控制参数不可调, 但用户订货时可指定。

Note: The controlling parameter can not be adjusted, but can be specified by users, when ordering.

3 产品规格及功能 Product specification and functions

■ WH03普通型温湿度控制器 WH03 general purpose temperature & humidity controller

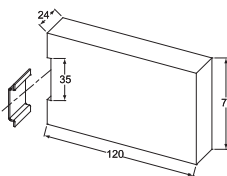
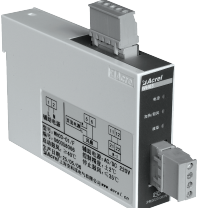
项目 型号 Type	基本功能(Basic function)	传感器(只) Sensor	尺寸(Size) (mm)	产品图片 (Product picture)
WH03-01/H	1路加热升温 One channel heating for rising temperature	W-1(1)	导轨安装 Guide rail mounting DIN35 	
WH03-01/F	1路鼓风降温 One channel blowing for decreasing temperature	W-1(1)		
WH03-10/H	1路加热除湿 One channel heating for removing moisture	H-1(1)		
WH03-02/H	2路检测1路加热升温 two channels detecting, one channel heating for rising temperature	W-1(2)		
WH03-02/F	2路检测1路鼓风降温 two channels detecting, one channel blowing for decreasing temperature	W-1(2)		
WH03-20/H	2路检测1路加热除湿 two channels detecting, one channel heating for removing moisture	H-1(2)		
WH03-11/HH	1路加热升温/1路加热除湿 One channel heating for rising temperature/ one channel heating for removing moisture	WH-1(1)		
WH03-11/HF	1路加热除湿/1路鼓风降温 One channel heating for removing moisture/one channel blowing for decreasing temperature	WH-1(1)		
WH03-02/HH	2路加热升温 two channels heating for rising temperature	W-1(2)		
WH03-02/HF	1路加热升温/1路鼓风降温 One channel heating for rising temperature/ one channel blowing for decreasing temperature	W-1(2)		
WH03-20/HH	2路加热除湿 two channels heating for removing moisture	H-1(2)		

WH03型辅助功能: LED工作状态指示; 加热器或风扇故障指示。

WH03 auxiliary function: LED working condition display; heater or fan fault display.

■ WH48普通型温湿度控制器 (WH 48 general purpose temperature & humidity controller)

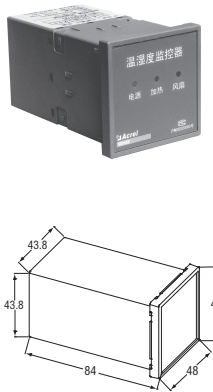
项目 型号 Type	基本功能(Basic function)	传感器(只) Sensor	尺寸(Size) (mm)	产品图片 (Product picture)
WH48-01/H	1路加热升温 One channel heating for rising temperature	W-1(1)	嵌入式安装, 面框: (embedded mounting panel frame) 48 × 48 开孔: (catout) 45 × 45	
WH48-01/F	1路鼓风降温 One channel blowing for decreasing temperature	W-1(1)		
WH48-10/H	1路加热除湿 One channel heating for removing moisture	H-1(1)		
WH48-02/H	2路检测1路加热升温 two channels detecting, one channel heating for rising temperature	W-1(2)		
WH48-02/F	2路检测1路鼓风降温 two channels detecting, one channel blowing for decreasing temperature	W-1(2)		
WH48-20/H	2路检测1路加热除湿 two channels detecting, one channel heating for removing moisture	H-1(2)		
WH48-11/HH	1路加热升温/1路加热除湿 One channel heating for rising temperature/ one channel heating for removing moisture	WH-1(1)		
WH48-11/HF	1路加热除湿/1路鼓风降温 One channel heating for removing moisture/one channel blowing for decreasing temperature	WH-1(1)		
WH48-02/HH	2路加热升温 two channels heating for rising temperature	W-1(2)		
WH48-02/HF	1路加热升温/1路鼓风降温 One channel heating for rising temperature/ one channel blowing for decreasing temperature	W-1(2)		
WH48-20/HH	2路加热除湿 two channels heating for removing moisture	H-1(2)		

WH48型辅助功能: LED工作状态指示
WH 48 auxiliary function: LED working condition display.

■ WH46普通型温湿度控制器 (WH46 general purpose temperature & humidity controller)

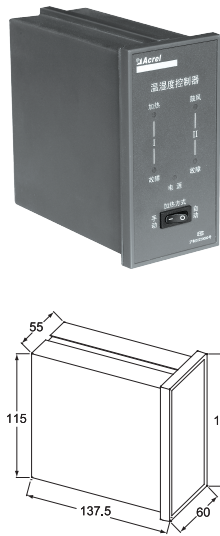
项目 型号 Type	基本功能(Basic function)	传感器(只) Sensor	尺寸(Size) (mm)	产品图片 (Product picture)
WH46-01/H	1路加热升温 One channel heating for rising temperature	W-1(1)	嵌入式安装, 面框: (embedded mounting panel frame) 60 × 120 开孔: (catout) 116 × 56	
WH46-01/F	1路鼓风降温 One channel blowing for decreasing temperature	W-1(1)		
WH46-10/H	1路加热除湿 One channel heating for removing moisture	H-1(1)		
WH46-02/H	2路检测1路加热升温 two channels detecting, one channel heating for rising temperature	W-1(2)		
WH46-02/F	2路检测1路鼓风降温 two channels detecting, one channel blowing for decreasing temperature	W-1(2)		
WH46-20/H	2路检测1路加热除湿 two channels detecting, one channel heating for removing moisture	H-1(2)		
WH46-11/HH	1路加热升温/1路加热除湿 One channel heating for rising temperature/ one channel heating for removing moisture	WH-1(1)		
WH46-11/HF	1路加热除湿/1路鼓风降温 One channel heating for removing moisture/one channel blowing for decreasing temperature	WH-1(1)		
WH46-02/HH	2路加热升温 two channels heating for rising temperature	W-1(2)		
WH46-02/HF	1路加热升温/1路鼓风降温 One channel heating for rising temperature/ one channel blowing for decreasing temperature	W-1(2)		
WH46-20/HH	2路加热除湿 two channels heating for removing moisture	H-1(2)		

WH46型辅助功能: LED工作状态指示; 故障报警指示; 一路加热器手动/自动控制方式选择开关; 报警输出(可选)。

WH46 auxiliary function: LED working condition display; fault alarm display; one selector for Manual /Auto heater controlling; alarming output(optional).

注:

1. W-1为单温度传感器, H-1为单湿度传感器, WH-1为温湿度一体传感器; 表格选定型号后传感器即已包括, 无须另行选定
2. 型号后加“-J”表示故障报警继电器输出。

Note:

1. W-1 is single temperature sensor, H-1 is single humidity sensor, WH-1 is temperature, humidity combined sensor, the type selecting form includes the needed sensor.
2. Adding "-J" after the Type to indicate output of the fault alarming relay.

4 接线方式 *Wiring mode*

WH48型:

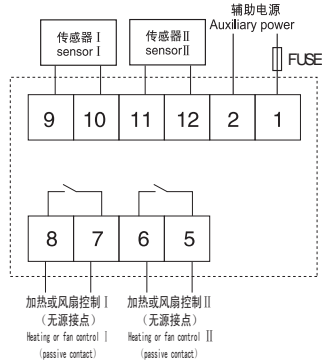

WH03型:

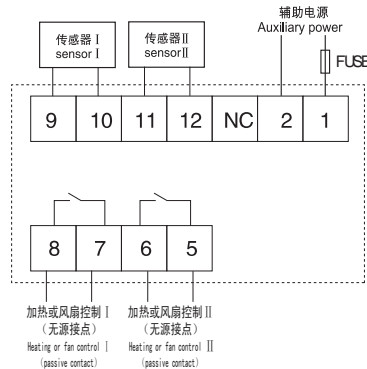

WH46型:

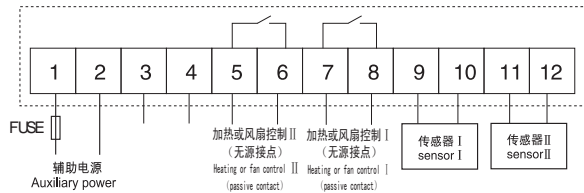

说明: 1. 以上接线方式仅作为参考, 具体操作请以实物上接线图为准;

2. 所有输出负载接点均为无源接点。

Explanation: 1. Please take wiring diagram on the controller as standard when operation.

2. All output load contacts are passive contacts.

二. WHD系列智能型温湿度控制器

WHD Series Intelligent Temperature & Humidity Controller

1 型号说明 *Type explanation*

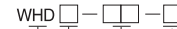

附加功能: C--RS485接口; M--变送输出; J--报警输出; 空白--无
Adding function: C-RS 485 port; M-transmitting output; J- alarming output; blank-nothing

控制功能选择: 1 1-1路温湿度 1 1-one channel temperature, humidity
2 2-2路温湿度 2 2-two channels temperature, humidity
3 3-3路温湿度 3 3-three channels temperature, humidity

仪表外形 (outline)

外形代号(outline code)	面框尺寸(panel frame size)
48方形(square)	48 × 48
72方形(square)	75 × 75
46槽形(rectangular)	120 × 60
96方形(square)	96 × 96
90R导轨形	Rail DIN 35
10R导轨形	Rail DIN 35

产品系列代号: 智能型温湿度控制器
product series code: intelligent temperature & humidity controller

注:

1. WHD48、WHD72、WHD90R、WHD10R、WHD96、WHD46分别最多可接1, 2, 3路温湿度传感器;
2. 每一路传感器对应二个控制输出接点(无源), 分别接加热器和风扇, 加热器用于升温或去湿, 风扇用于降温;
3. WHD72、WHD90R、WHD96、WHD46辅助功能有: RS485通讯功能、报警输出功能、变送功能, 只能三者选一; WHD10R的辅助功能有: RS485通讯功能、报警输出功能, 二者可同时选择; “-C”表示通讯,“-J”表示报警,“-M”表示变送;
4. 传感器与控制器之间的连接线必须使用四芯屏蔽线, 长度最大不得超过20米。

Note:

1. Number of temperature, humidity(or temperature) sensor to be connected with WHD48、WHD72、WHD90R、WHD10R、WHD96、WHD 46 is up to 1,2, 3 respectively;
2. Every sensor match with two control output contacts(passive), connected with heater and fan respectively, the heater is used for rising temperature or removing moisture, the fan is used for decreasing temperature;
3. Auxiliary function of WHD72、WHD90R、WHD96、WHD46: RS485 communication, alarming output function and transmitting function. Only one can be selected. Auxiliary function of WHD10R: RS485 communication and alarming output function. Both can be selected at the same time. “-C” for communication, “-J” for alarming, “-M” for transmitting.
4. The connecting wire between sensor and controller must use four-core shielded cable. And its maximum length must not exceed 20 m.

2 技术指标 *Technical data*

技术参数 (Technical parameter)		指标 (Value)
测量范围 (Measuring range)	温度 (Temperature)	-40.0℃ ~ +99.9℃
	湿度 (Humidity)	20%RH~90%RH
精度 (Precision)	温度 (Temperature)	± 1℃
	湿度 (Humidity)	± 5%RH
变送输出 Transmitting output		DC 4~20mA 或 DC 0~20mA
控制参数设定范围 (Set range of controlling parameter)	加热升温 (Heating for temperature rising)	-40.0℃ ~ +40.0℃
	鼓风降温 (Blowing for temperature decreasing)	0.0℃ ~ +100.0℃
	湿度控制 (Humidity control)	20%RH~90%RH
输出触点容量 (output contact capacity)		5A/AC250V
通讯接口 (Communication port)		RS485, MODBUS(RTU)协议
辅助电源 Auxiliary power	电压 Voltage	AC 85~265V DC 100~350V
	功耗 Consumption	基本功耗(≤0.8w)+继电器功耗(每路≤0.7w) Basic power consumption(≤0.8w) + relay power consumption(each channel≤0.7w)
绝缘电阻 (Insulation resistance)		≥ 100MΩ
工频耐压 (power-frequency withstand voltage)		电源与外壳可触及金属件/电源与其它端子组2kV/1min(AC, RMS) power with shell, touchable metal parts/ power with other terminal group
平均无故障工作时间 (average work time without stoppage)		≥ 50000小时 (hour)
工作环境 (控制器) working condition (controller)	温度(Temperature)	-10℃ ~ +55℃
	湿度(Humidity)	≤95%RH, 不结露, 无腐蚀性气体 (without condensation and corrosive gas)
	海拔(Altitude)	≤2500米 (m)

回滞量: 温湿度控制过程中, 执行部件 (加热器或风扇) 启动工作时的温度或湿度值与停止工作时的温度或湿度值之差称为回滞量。

Start/stop gap: In the control process, for the execution part (heater or fan), the difference between starting temperature (humidity) and stopping temperature (humidity).

3 产品规格及功能 *Product specification and functions*

■ WHD48型 不可带辅助功能

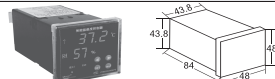
型号 (Type)	功能 (Function)	传感器 (只) Sensor	安装方式 (Mounting mode)	外形、尺寸 (Outline, size)
WHD48-11	1路温湿度控制 One temperature and humidity control	WH-2(1)	嵌入式 (Embedded) 开孔: 45 × 45	

■ WHD72型 可带辅助功能: 故障报警“-J”、通信“-C”、变送“-M”

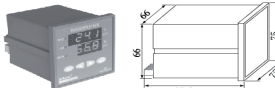
型号 (Type)	功能 (Function)	传感器 (只) Sensor	安装方式 (Mounting mode)	外形、尺寸 (Outline, size)
WHD72-11	1路温湿度控制 One channel temperature, humidity control	WH-2(1)	嵌入式 (Embedded) 开孔: 67 × 67	

■ WHD10R型 可带辅助功能: 故障报警“-J”、通信“-C”，二者可共选

型号 (Type)	功能 (Function)	传感器 (只) Sensor	安装方式 (Mounting mode)	外形、尺寸 (Outline, size)
WHD10R-11	1路温湿度控制 One channel temperature, humidity control	WH-2(1)	导轨式 (Rail) DIN 35	

■ WHD90R型 可带辅助功能: 故障报警“-J”、通信“-C”、变送“-M”

型号 (Type)	功能 (Function)	传感器 (只) Sensor	安装方式 (Mounting mode)	外形、尺寸 (Outline, size)
WHD90R-11	1路温湿度控制 One channel temperature, humidity control	WH-2(1)	导轨式 (Rail) DIN 35	

■ WHD96型 可带辅助功能: 故障报警“-J”、通信“-C”、变送“-M”

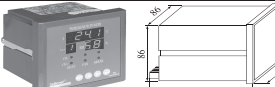
型号 (Type)	功能(Function)	传感器 (只) Sensor	安装方式 (Mounting mode)	外形、尺寸 (Outline, size)
WHD96-11	1路温湿度控制 One channel temperature, humidity control	WH-2(1)	嵌入式 (Embedded)	
WHD96-22	2路温湿度控制 two channels temperature, humidity control.	WH-2(2)	开孔: (catout) 88 × 88	

■ WHD46型 可带辅助功能: 故障报警“-J”、通信“-C”、变送“-M”

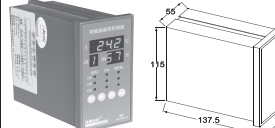
型号 (Type)	功能 (Function)	传感器 (只) Sensor	安装方式 (Mounting mode)	外形、尺寸 (Outline, size)
WHD46-11	1路温湿度控制 One channel temperature, humidity control	WH-2(1)	嵌入式 (Embedded) 开孔: (catout) 116 × 56	
WHD46-22	2路温湿度控制 two channels temperature, humidity control	WH-2(2)		
WHD46-33	3路温湿度控制 three channels temperature, humidity control	WH-2(3)		

4 接线方式 Wiring mode

■ WHD48型:

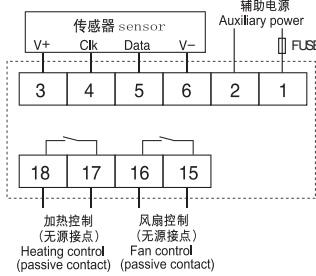

■ WHD72型:

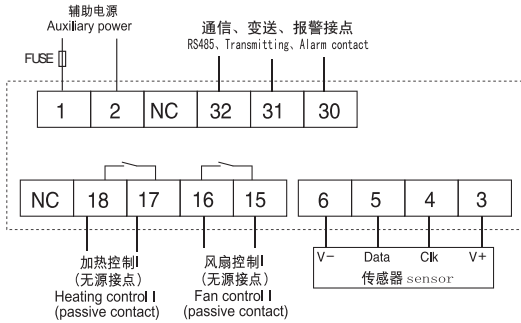

■ WHD90R型:

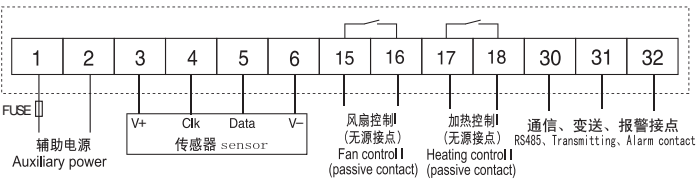

■ WHD10R型:

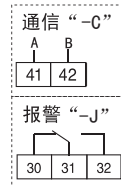
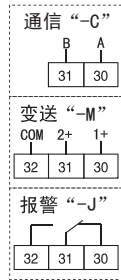
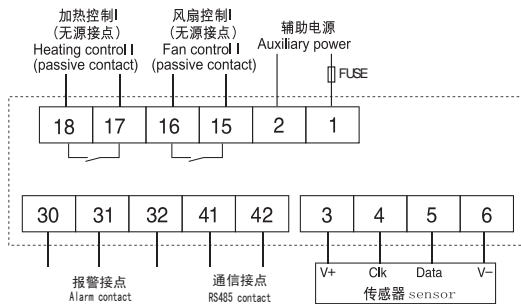

■ WHD96型:

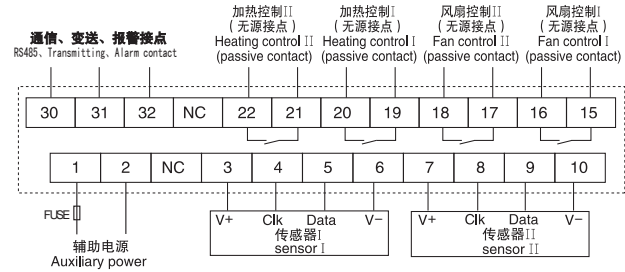

■ WHD46型:

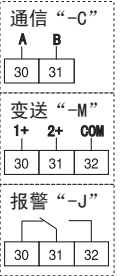
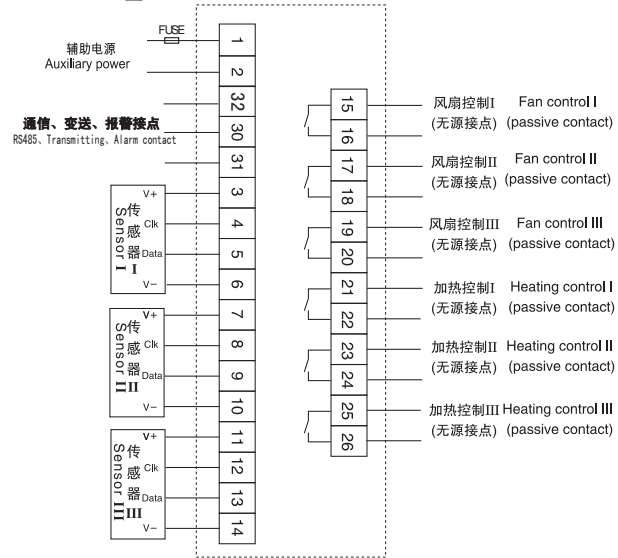

关于通讯部分的接线实例如下图所示:
Four connection mode in communication section are shown as following:

正确接线方式: 通讯电缆屏蔽层接地
Correct connection mode: Communication cable shielding layer is connected with ground.

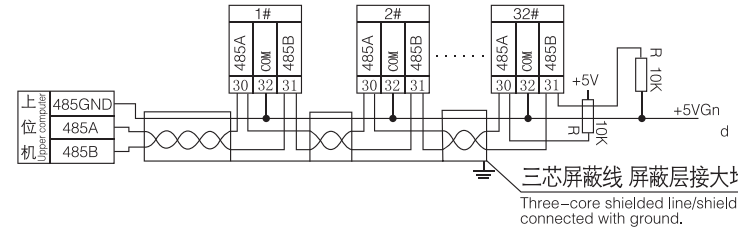

建议最末端仪表的A、B之间加匹配电阻, 阻值范围为120Ω~10kΩ。

Recommendation of adding matched resistance between A, B of the last meter, the rated resistance range is 120Ω~10kΩ.

注: 在通信接线时, 建议采用三芯屏蔽线, 端子32“COM”严禁直接接柜体或大地。

5 产品操作指南 Product operation manual

5.1 显示介绍 Display introduction

5.1.1 面板图示 Front diagram

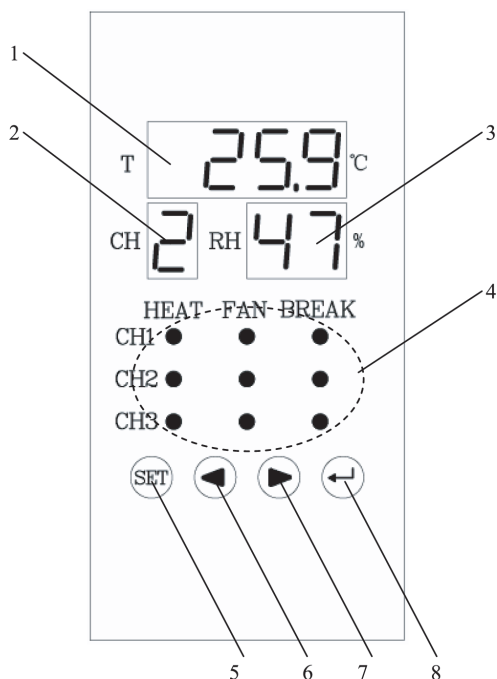

5.1.2 图例说明 Legend explanation

编号 (No.)	名称 (Name)	状态示例 (Status)	说明 (Explanation)
1	温度显示区域 (temperature Area Temp. area)	xx.x °c	显示当前测量的温度值，显示范围：-40.0c ~ 99.9c 按键编程时显示菜单及数据 (Display current-measured temperature value, range : -40.0c ~ 99.9c Display menu and data for keystroke programming)
2	通道显示 (Channels)	x	显示当前所测量的通道，显示范围：1~3 (Display current-measured channels, range : 1~3)
3	湿度显示区域 (humidity Area Humidity area)	xx%	显示当前所测量的湿度值，显示范围：20%~90% (Display current-measured humidity value, range : 20%~90%)
4	工作状态指示灯 (Working status)	指示灯点亮 (Indicator lightening)	对应显示通道1、2、3的工作状态，有加热 (HEAT)、鼓风 (FAN)、加热故障 (BREAK) Working state of 1, 2, 3, channels, heating (HEAT), blowing (FAN), fault of heating (BREAK)
5	SET	按下 Pressing	选择操作功能，进行编程设置 (Selecting operational function, set up programming)
6	左方向键 (Left directional key)	按下 Pressing	查看数据或数据减 (Look over data or change data)
7	右方向键 (Right directional key)	按下 Pressing	查看数据或数据增 (Look over data or change data)
8	ENTER键	按下 Pressing	确定功能或进入下一级菜单 (Confirm function or go to next menu)

5.2 系统上电 System powered

依照说明正确接线后，接通电源即进入工作状态。

5.3 工作状态 Working status

5.3.1 测量 Measurement

在测量状态下，区域1、2、3显示当前测量通道及温度、湿度值，并且三个传感器通道的温湿度值循环测量、显示。

5.3.2 控制 Control

当环境的温度或湿度值满足预先设置的工作条件时，启动加热器或风扇，同时对应的指示灯点亮（区域4），当加热器发生故障，没有按条件工作时，相应的加热故障指示灯点亮，以示报警。

5.3.3 控制测试 Control test

在正常工作状态下，按住左方向键大于5秒，所有工作正常的通道无条件加热；按住右方向键大于5秒，所有工作正常的通道无条件鼓风。

5.4 系统设置模式 System setting mode

5.4.1 进入/退出系统设置模式 Entry/exit system setting mode

在正常情况下，仪表处于正常工作状态，此时按下SET键持续3秒，进入系统设置模式，按回车键输入密码，出厂默认为0000，密码正确（显示YES），自动进入主菜单。

进入主菜单后区域1显示 "CH1"，按回车键进入通道1工作参数设置，按左右键则切换到其他同一级菜单，这一级菜单有 "CH2"，"CH3"，"COMM"，"DISP"，"tr. 1"，"tr. 2"，"VERn"，分别为设置通道2，通道3的工作参数，设置通讯，设置显示模式，变送通道设置1，变送通道设置2，查看软件名称。

After wiring correctly according to the instruction, power on and enter into the measuring condition

Under measuring condition, Area 1, 2, 3 display currently: measuring channel and temperature value, humidity value, temperature value, humidity value circling measurement and display of three sensor's channels.

When environmental temperature value or humidity value satisfy the presetting working condition, starting the heater or fan, while corresponding indicator lights (Area4), when the heater is failure, working without as per the normal working condition, the corresponding indicator for heating-fault lights to give alarming.

Under the normal working condition, hold pressing the left directional key about 5 seconds, all the normal channel are in heating; hold pressing the right directional key over 5 seconds, all the normal channel are in blowing.

Under the normal working condition, hold pressing the SET key about 3 seconds, entry in system setting mode, stroke ENTER and input the pass words, the deliver default value as 0000, if pass words is correct (display YES), enter into the main menu automatically.

After enter into the main menu, Area1 display "CH1", stroke ENTER, enter into the working parameter setting of channel 1, press the left/right key to switch to other menu with same level, this level menu has "CH2", "CH3", "COMM", "DISP", "VERn", setting up working parameter of channel 2, channel 3, communication, display mode, look over software name respectively.

5.4.2 对通道参数的设置 Setting channel parameters

CH1、CH2、CH3的参数设置过程完全相同。以下以CH1为例作详细说明。进入系统设置后，菜单及数据显示在区域1中，区域2在进入通道设置后显示通道序号。进入CH1前显示：

The parameter setting process of CH1, CH2, CH3 is one and the same. Taking CH1 as example, to explain clearly: After setting entry system, menu and data display in Area1, after setting entry channel, Area2 display channel sequence number. Display before entry in.CH1:

	显示实例 Example	解释 Explanation
1	CH1	单击回车进入通道1参数设置 Single click ENTER, enter into parameter setting of channel 1
2		空白 Blank

单击回车显示如下 Single click ENTER the display as follows:

	显示实例 Example	解释 Explanation
1	ON	允许通道1，左右键选择"on"/"oFF"，回车键确认 Allow channel 1, selecting left/right key for "on"/"off", click ENTER for confirm
2	1	当前设置的是第一通道 Current setting is the first channel

选择"on"，单击回车显示如下 Selecting "on", Single click ENTER the display as follows:

	显示实例 Example	解释 Explanation
1	H.dry	单击回车进入，设置加热去湿启动的湿度值 Single click ENTER for entry, setting humidity value for starting process of heating and removing moisture
2	1	当前设置的是第一通道 Current setting is the first channel

单击回车显示如下 Single click ENTER the display as follows:

	显示实例 Example	解释 Explanation
1	85	单击左右键修改，按住不放快速增减，回车确认 Single click left/right key for revising, hold pressing for increasing/decreasing quickly, click ENTER for confirm
2	1	当前设置的是第一通道 Current setting is the first channel

单击回车显示如下 Single click ENTER the display as follows:

	显示实例 Example	解释 Explanation
1	HEAt	单击回车进入，设置加热升温启动温度值 Single click ENTER for entry, setting temperature value for starting process of heating and temperature rising
2	1	当前设置的是第一通道 Current setting is the first channel

单击回车显示如下 Single click ENTER the display as follows:

	显示实例 Example	解释 Explanation
1	5.0	单击左右键修改, 按住不放快速增减, 回车确认 Single click left/right key for revising, hold pressing for increasing/decreasing quickly, click ENTER for confirm
2	1	当前设置的是第一通道 Current setting is the first channel

单击回车显示如下 Single click ENTER the display as follows:

	显示实例 Example	解释 Explanation
1	ALM.H	单击回车进入, 设置是否打开加热故障报警 Single click ENTER for entry, setting if open heating-fault alarm
2	1	当前设置的是第一通道 Current setting is the first channel

单击回车显示如下 Single click ENTER the display as follows:

	显示实例 Example	解释 Explanation
1	OFF	左右键选择"on"/"oFF", 回车键确认 selecting left/right key for "on"/"off", click ENTER for confirm
2	1	当前设置的是第一通道 Current setting is the first channel

单击回车显示如下 Single click ENTER the display as follows:

	显示实例 Example	解释 Explanation
1	FAn.C	单击回车进入, 设置鼓风降温启动温度值 Single click ENTER for entry, setting temperature value to start blowing-reducing temperature
2	1	当前设置的是第一通道 Current setting is the first channel

单击回车显示如下 Single click ENTER the display as follows:

	显示实例 Example	解释 Explanation
1	40.0	单击左右键修改, 按住不放快速增减, 回车确认 Single click left/right key for revising, hold pressing for increasing/decreasing quickly, click ENTER for confirm
2	1	当前设置的是第一通道 Current setting is the first channel

单击回车显示如下 Single click ENTER the display as follows:

	显示实例 Example	解释 Explanation
1	HYS.X	单击回车进入, 设置该通道回滞量 Single click ENTER for entry, setting hysteresis value of this channel
2	1	当前设置的是第一通道 Current setting is the first channel

单击回车显示如下 Single click ENTER the display as follows:

	显示实例 Example	解释 Explanation
1	5	单击左右键修改, 回车确认 Single click left/right key for revising, click ENTER for confirm
2	1	当前设置的是第一通道 Current setting is the first channel

单击回车返回主菜单, 此时可以左右键选择其他主菜单选项进行设置。通讯"COMM"可设置本机地址(1~247)及通讯波特率(1200、2400、4800、9600、19200)。显示模式"DISP"设置三个通道循环测量显示的间隔时间, 有关闭循环或间隔2s、4s、6s、8s。在主菜单任意位置, 单击SET选择是否保存并退出系统设置, 返回正常工作模式。

Single click the Enter, return the main menu, use left/right key to select other main menu and setup the optional item. The communication "COMM" may set up Local address (1~247) and Communication baud rate value (1200, 2400, 4800, 9600, 19200). The display mode "DISP" is used to set three channels: interval in circling measurement display; closed circling or interval for 2s, 4s, 6s, 8s. At random position of main menu, single click SET to select storage or not and exit system setting, then return back normal working mode.

5.4.3 对系统密码的设置 Set up system password

同时按住SET键和回车键大于3秒, 显示: "CodE", 单击回车进入, 输入当前系统密码。单击回车确认所输入的密码, 正确则显示"yES", 并自动转入"n.Cod", 单击进入, 输入新的密码, 回车选择是否保存并退出。

在任意设置位置, 若1分钟内无有效按键被按下, 则系统自动回到测量状态, 设置不被保存。

Press SET and ENTER simultaneously about three seconds, display: "CodE". Single click ENTER for entry, type current system password. Single click ENTER to confirm the typed password, the correct password display "yES", and switch to "n.Cod" automatically, single click entry to type new password, press ENTER to select storage or not, then to exit. At random setting position, if within 1 minutes, no effective key is pressed, the system return to measuring status automatically, the setting is not stored.

5.4.4 用户编程流程图 User's Programming flow diagram

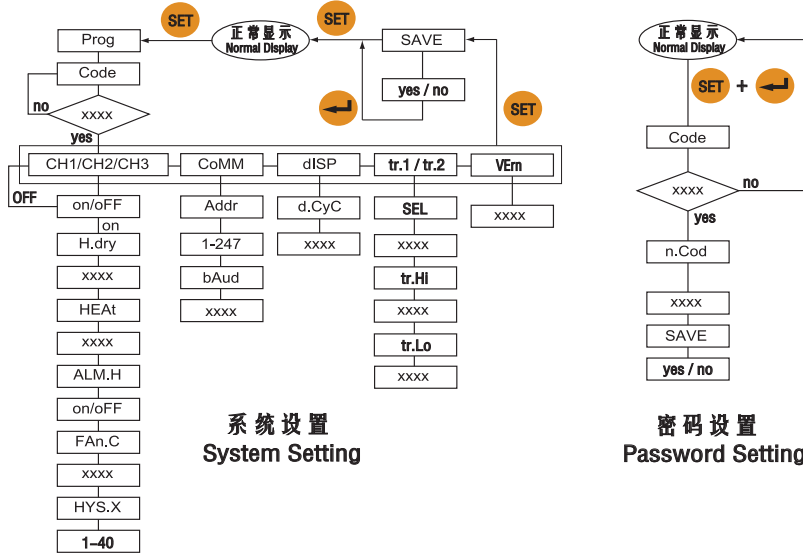

6 通讯指南 Communication manual

6.1 通讯 Communication

在本章主要讲述如何利用软件通过通讯口来操控该系列仪表。本章内容的掌握需要您具有MODBUS协议的知识储备并且通读了本册其它章节所有内容，对本产品功能和应用概念有较全面了解。

本章内容包括：MODBUS协议简述，通讯应用格式详解，本机的应用细节及参量地址表。

This chapter mainly explains how to use software to operate this series meter by communication interface. You are required to obtain the knowledge of MODBUS protocol and have general comprehension of the meter's function and application after reading through out other content of this manual.

The content of this chapter includes: brief introduction of MODBUS protocol, detailed explanation of communicate application format, application details of the meter and parameter address table.

6.1.1 MODBUS协议简述 Communication

WHD系列智能型温湿度控制器使用的是MODBUS-RTU通讯协议，MODBUS协议详细定义了校验码、数据序列等，这些都是特定数据交换的必要内容。MODBUS协议在一根通讯线上使用主从应答式连接（半双工），这意味着在一根单独的通讯线上信号沿着相反的两个方向传输。首先，主计算机的信号寻址到一台唯一的终端设备（从机），然后，终端设备发出的应答信号以相反的方向传输给主机。

MODBUS协议只允许在主机（PC，PLC等）和终端设备之间通讯，而不允许独立的终端设备之间的数据交换，这样各终端设备不会在它们初始化时占据通讯线路，而仅限于响应到达本机的查询信号。

WHD Series Intelligent Temperature & Humidity Controller. MODBUS protocol defines detailedly checkout code, data sequence and so on which are necessary content of specific data change. MODBUS protocol uses half duplex connection mode in one communication wire. That means signals of a separate wire transfer along contrary direction. Firstly, signal of host computer seeks address to a exclusive terminal unit, then terminal unit sends out responding signal that is transmitted to the host computer with contrary direction.

MODBUS protocol only allows communication between mainframe(PC, PLC etc.) and terminal unit, it doesn't permit data change between separate terminal equipment. Each terminal unit will not occupy communication wire while initializing, it only responses to rogatory signal itself.

字符 Character	文字说明 Explanation	字符 Character	文字说明 Explanation
Prog	进入编程设置 Access programming	CoMM	通讯设置 Communication
CodE	密码 Password	Addr	地址 Address
xxxx	数字或其他内容 Figure and others	bAud	波特率 Baud rate
CH1/CH2/CH3	进入通道1/2/3 Access channels	dISP	显示设置 Display setting
H.dry	加热去湿 Heating to remove moisture	d.Cyc	循环显示 Circling display
HEAt	加热升温 Heating to rise temperature	VErn	软件版本号 Version No. of software
ALM.H	加热器断线报警 Heater alarm for broken wire	n.Cod	输入密码 Typing password
Fan.C	鼓风降温 Blow to reduce temperature	SAVE	保存 Storage
HYS.X	回滞量 hysteresis value	ruPt	传感器故障 Sensor failure
tr.1/tr.2	变送通道设置 Deliver access programming	SEL	变送输出对应选择 relevant output select
tr.Hi	高点设置 programming high	tr.Lo	低点设置 programming low

6.1.2 查询-回应周期 Searching-responding period



图 1 主-从 查询-回应周期表

查询 Searching

查询消息中的功能代码告之被选中的从设备要执行何种功能。数据段包含了从设备要执行功能的任何附加信息。例如功能代码03是要求从设备读保持寄存器并返回它们的内容。数据段必须包含要告之从设备的信息：从何寄存器开始读及要读的寄存器数量。错误检测域为从设备提供了一种验证消息内容是否正确的方法。

Function code of searching information tells the selected slave unit should carry out which kinds of function. Data segment includes any addition information that the slave unit will operate the function. For example, function code 03 required reading keep register from slave unit and returning their content. Data segment should contain the information that will be sent to slave unit: read from which register and the number of register. Error detecting region supplies slave unit with a method that can validate if the information content is correct.

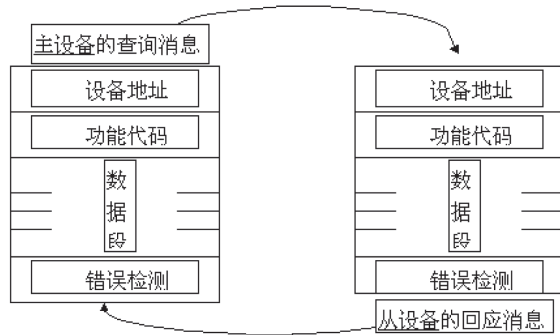
回应 Responding

如果从设备产生一正常的回应，在回应消息中的功能代码是在查询消息中的功能代码的回应。数据段包括了从设备收集的数据：如寄存器值或状态。如果有错误发生，功能代码将被修改以用于指出回应消息是错误的，同时数据段包含了描述此错误信息的代码。错误检测域允许主设备确认消息内容是否可用。

If the slave unit brings a normal response, function code of the response information is the response of function code in searing information. Data segment includes collecting data of slave unit: such as register value or state. If error occurs, function code will be amended to indicate the response information is wrong, meanwhile, data segment contains the code which describes this error. Error detecting region allows main unit affirm if the information is usable.

6.1.3 传输方式 Transmit mode

传输方式是指一个数据帧内一系列独立的数据结构以及用于传输数据的有限规则，下面定义了与MODBUS 协议RTU方式相兼容的传输方式。

每个字节的位：

- 1个起始位
- 8个数据位，最小的有效位先发送
- 无奇偶校验位
- 1个停止位

错误检测(Error checking)

CRC (循环冗余校验)

Transmit mode is a series of data configuration in a data frames and finity rule used for data transmission. Transmit mode that is compatible with MODBUS protocol-RTU mode is defined as follows.

Bit of each byte:

- 1 start bit
- 8 data bits, the minimal efficient bit delivering first
- No parity check bit
- 1 stop bit

Error checking: CRC(circle redundancy check)

6.1.4 协议 Protocol

当数据帧到达终端设备时，它通过一个简单的“端口”entry被寻址到的设备，该设备去掉数据帧的“信封”（数据头），读取数据，如果没有错误，就执行数据所请求的任务，然后，它将自己生成的数据加入到取得的“信封”中，把数据帧返回给发送者。返回的响应数据中包含了以下内容：终端从机地址(Address),被执行了的命令(Function),执行命令生成的被请求数据(Data)和一个校验码(Check)。发生任何错误都不会有成功的响应，或者返回一个错误指示帧。

When data frame reaches terminal unit, it enters searching addressed unit from a simple "port" . The unit takes out the "envelop" (data head) and reads data, then carries out mission required by data if there is no error. After that, the unit adds the produced data to "envelop" and returns data frame to sender. Response data returned includes: Address of terminal slave unit, Function carried out, Data produced and a Check. There is no successful response if any error occurs, or return to a false frame.

数据帧格式 Data frame format

地址 Address	功能 Function	数据 Data	校验 Check
8-Bits	8-Bits	N x 8-Bits	16-Bits

地址域 Address region

地址域在帧的开始部分，由一个字节（8位二进制码）组成，十进制为0~255，在我们的系统中只使用1~247,其它地址保留。这些位标明了用户指定的终端设备的地址，该设备将接收来自与之相连的主机数据。每个终端设备的地址必须是唯一的，仅仅被寻址到的终端会响应包含了该地址的查询。当终端发送回一个响应，响应中的从机地址数据便告诉了主机哪台终端正与之进行通信。

功能域 Function region

功能域代码告诉了被寻址到的终端执行何种功能。下表列出了该系列仪表用到的功能码，以及它们的意义和功能。

代码 Code	意义 Meaning	行为 Action
03 或(or) 04	读数据寄存器 Read data register	获得一个或多个寄存器的当前二进制值 Acquire one or several current binary value of register
16	预置多寄存器 Preset multi-register	设定二进制值到一系列多寄存器中 Set binary value to series of multi-register

数据域 Date region

数据域包含了终端执行特定功能所需要的数据或者终端响应查询时采集到的数据。这些数据的内容可能是数值,参考地址或者设置值。例如：功能域码告诉终端读取一个寄存器，数据域则需要指明从哪个寄存器开始及读取多少个数据，内嵌的地址和数据依照类型和从机之间的不同内容而有所不同。

错误校验域 Error-checking region

该域允许主机和终端检查传输过程中的错误。有时，由于电噪声和其它干扰，一组数据在从一个设备传输到另一个设备时在线路上可能会发生一些改变，出错校验能够保证主机或者终端不去响应那些传输过程中发生了改变的数据，这就提高了系统的安全性和效率，错误校验使用了16位循环冗余的方法（CRC16）。

Address region which is the beginning of frame consists of a byte(8 bits binary code). The decimalist is 0~255, and the system uses 1~247. The bits indicate address of terminal unit appointed by users which acquire data from the connected host computer. Address of each terminal unit must be exclusive, and the address searched terminal will bring address search. When terminal returns a response, slave address data of response tells host computer with which terminal is communicating.

Function region code tells the address searched terminal which function to carry out. Function codes used in meter are as follows.

Data region includes the data which terminal needed to carries out specific function or which is sampled when terminal responses searching. The content of data maybe numerical value, reference address or setup value. For example: Function

Check region allows error between host computer and terminal transmission. Sometimes because of electrical noise and other disturbance, a set of data may change while transmitting from one unit to another, error- checking can assure host or terminal not to answer the changed data. It improves the security and efficiency of system. Error-checking adopts CRC16 method.

6.1.5 协议 Protocol

错误校验（CRC）域占用两个字节，包含了一个16位的二进制值。CRC值由传输设备计算出来，然后附加到数据帧上，接收设备在接收数据时重新计算CRC值，然后与接收到的CRC域中的值进行比较，如果这两个值不相等，就发生了错误。

CRC运算时，首先将一个16位的寄存器预置为全1，然后连续把数据帧中的每个字节中的8位与该寄存器的当前值进行运算，仅仅每个字节的8个数据位参与生成CRC，起始位和终止位以及可能使用的奇偶位都不影响CRC。在生成CRC时，每个字节的8位与寄存器中的内容进行异或，然后将结果向低位移位，高位则用“0”补充，最低位（LSB）移出并检测，如果是1，该寄存器就与一个预设的固定值（0A001H）进行一次异或运算，如果最低位为0，不作任何处理。

上述处理重复进行，直到执行完了8次移位操作，当最后一位（第8位）移完以后，下一个8位字节与寄存器的当前值进行异或运算，同样进行上述的所有8次移位异或操作，当数据帧中的所有字节都作了处理，生成的最终值就是CRC值。

生成一个CRC的流程为：

- 预置一个16位寄存器为0FFFFH（全1），称之为CRC寄存器。
- 把数据帧中的第一个字节的8位与CRC寄存器中的低字节进行异或运算，结果存回CRC寄存器。
- 将CRC寄存器向右移一位，最高位填以0，最低位移出并检测。
- 如果最低位为0：重复第三步（下一次移位）；如果最低位为1：将CRC寄存器与一个预设的固定值（0A001H）进行异或运算。
- 重复第三步和第四步直到8次移位。这样处理完了一个完整的八位。
- 重复第2步到第5步来处理下一个八位，直到所有的字节处理结束。
- 最终CRC寄存器的值就是CRC的值。

此外还有一种利用预设的表格计算CRC的方法，它的主要特点是计算速度快，但是表格需要较大的存储空间，该方法此处不再赘述，请参阅相关资料。

CRC region occupies 2 bytes, binary value 16 bits. CRC value is accounted by transmit unit, then adds to data frame. Receiver unit accounts CRC value again while receiving data, then compares with the value of CRC region. If the two are unlikeness, there is an error.

While CRC operating, Preset 16 bits register 1 beforehand, then operate the 8 bits of each byte in data frame and current value of register continuously. Only 8 data bits of each byte participate in creating CRC, which is not influenced by start bit, stop bit and parity bit. While creating CRC. 8 bits of each byte exclusive OR with the content in register. The result is moved to low bit, "0" is used in high bit. LSB moves out and will be detected, if 1, the register carries out a exclusive OR operation with a preset fixed value(0A001H), if the lowest bit is 0, do nothing.

Operation above carries repeatedly till 8 bit moving is completed. When the last bit moves, next 8 bits carries out exclusive OR operation with current value of register, while operating another said 8 bit moving exclusive OR operation. All bytes are operated, CRC value is the final value. Flow to create a CRC:

- Preset a 16 bits register 0FFFFH beforehand, which is called CRC register.
- The 8 bits of first byte in data frame carries out exclusive OR operation with the low byte in CRC register and store the result in CRC register.
- Move CRC register one bit to right, define the highest 0, move out the lowest and check it.
- If the lowest bit is 0, repeat step 3; if is 1, the register carries out a exclusive OR operation with a preset fixed value (0A001H)
- Repeat the step 3 and 4 till the eighth moving. A whole 8 bits is transacted.
- Repeat step 2 to 5 to deal with next 8 bits till all bytes to be transacted.
- CRC value is the final CRC register value.

In addition, there is a way to account CRC by presetting a table beforehand. The main characteristic is speediness of account, but the table needs biggish storage space.

6.2 通讯应用格式详解 Communication format explanation

本节所举实例将尽可能的使用如图所示的格式，（数字为16进制）。
Examples as follows is used as tables (hexadecimal)

从机地址 Addr	功能码 Fun	数据起始地址 寄存器高字节 Data start reg hi	数据起始地址 寄存器低字节 Data start reg lo	数据读取个数 寄存器高字节 Data #of regs hi	数据读取个数 寄存器低字节 Data #of regs lo	循环冗余校验 低字节 CRC16 lo	循环冗余校验 高字节 CRC16 hi
01H	03H	00H	00H	00H	03H	05H	CBH

6.2.1 读数据（功能码03或04） Reading(function code 03 or 04)

查询数据帧 Searching data frame

此功能允许用户获得设备采集与记录的数据及系统参数。主机一次请求的数据个数没有限制，但不能超出定义的范围。

下面的例子是从01号从机读2个采集到的基本数据，CH1的温度值和湿度值，其中温度值的地址是0001H，湿度值的地址是0002H，长度都是2个字节。

This function allows user acquire system parameter and data of sampled and recorded by unit. It is not limited for data number of required by host computer, but can't beyond the defined address range.

The following example show that from 01 slave computer to read two collected basic data reading, CH1 temperature value and humidity value, address of temperature value is 0003H, address of humidity value is 0004H, both length is 2 byte.

从机地址 Addr	功能码 Fun	数据起始地址 寄存器高字节 Data start reg hi	数据起始地址 寄存器低字节 Data start reg lo	数据读取字节数 寄存器高字节 Data #of regs hi	数据读取字节数 寄存器低字节 Data #of regs lo	循环冗余校验 低字节 CRC16 lo	循环冗余校验 高字节 CRC16 hi
01H	03H	00H	01H	00H	02H	95H	CBH

响应数据帧 Response data frame

响应包含从机地址、功能码、数据的字节长度、数据和CRC错误校验。

下面是读取CH1温度，湿度值的响应。

Response includes slave computer address, function code, byte length of data, data and CRC error-checking.

Following example is response of reading CH1 temperature, humidity value.

从机地址 Addr	功能码 Fun	字节计数 Byte count	数据1 高字节 Data1 hi	数据1 低字节 Data1 lo	数据2 高字节 Data2 hi	数据2 低字节 Data2 lo	循环冗余 校验低字节 CRC16 lo	循环冗余 校验高字节 CRC16 hi
01H	03H	04H	01H	20H	02H	5EH	7AH	9DH

温度 = (0120H) / 0AH = 288 / 10 = 28.8℃

湿度 = (025EH) / 0AH = 606 / 10 = 60.6%

以下是参数读取的地址表：

temperature = (0120H) / 0AH = 288 / 10 = 28.8℃

humidity = (025EH) / 0AH = 606 / 10 = 60.6%

The address table for reading parameters is shown as following:

地址 Address	数据内容 Data Content	数据类型 Data type	读/写 Read/Write	命令字 command word	备注 Note
0	工作状态: bit0~bit3 为第1路 工作状态: bit4~bit7 为第2路 工作状态: bit8~bit11 为第3路 BH0 加热器状态 0=正常 1=故障 BH1 传感器状态 0=正常 1=故障 BH2 加热状态 0=停止 1=加热 BH3 鼓风状态 0=停止 1=鼓风	Unsigned int	R	0.3、04	0 ~ 4095
1	通道1所测温度值 Temperature value measured in channel 1	signed int	R	0.3、04	
2	通道1所测湿度值 Humidity value measured in channel 1	signed int	R	0.3、04	
3	通道2所测温度值 Temperature value measured in channel 2	signed int	R	0.3、04	
4	通道2所测湿度值 Humidity value measured in channel 2	signed int	R	0.3、04	
5	通道3所测温度值 Temperature value measured in channel 3	signed int	R	0.3、04	
6	通道3所测湿度值 Humidity value measured in channel 3	signed int	R	0.3、04	
7	仪表通讯地址 Meter communication address	Unsigned int	R/W	0.3、04 / 16	1~247
8	仪表通讯波特率 Meter communication baud rate	Unsigned int	R/W	0.3、04 / 16	0~4 分别代表1200~19200 0~4 show 1200~19200 respectively
9	报警允许及：通道允许 bit0~bit1 为第1路 bit2~bit3 为第2路 bit4~bit5 为第3路 bit0第1路加热器故障检测: 0允许1禁止 bit1第1路通道是否打开: 0允许1禁止	Unsigned int	R/W	0.3、04 / 16	0 ~ 63
10	仪表显示模式 Meter display mode	Unsigned int	R/W	0.3、04 / 16	循环时间 (S) ,OFFH 为不循环 Cycling time(S), OFFH indicate non-cycling
11	通道1排风设定温度 Temperature set for blowing in channel 1	signed int	R/W	0.3、04 / 16	0 ~ 1000
12	通道1加热设定温度 Humidity set for heating in channel 1	signed int	R/W	0.3、04 / 16	10 ~ 999
13	通道1加热设定温度 Temperature set for heating in channel 1	signed int	R/W	0.3、04 / 16	-400 ~ 1000
14	通道1各回滞量值 Each hysteresis value in channel 1	Unsigned int	R/W	0.3、04 / 16	1 ~ 40
15	通道2排风设定温度 Temperature set for blowing in channel 2	signed int	R/W	0.3、04 / 16	0 ~ 1000
16	通道2加热设定温度 Humidity set for heating in channel 2	signed int	R/W	0.3、04 / 16	10 ~ 999
17	通道2加热设定温度 Temperature set for heating in channel 2	signed int	R/W	0.3、04 / 16	-400 ~ 1000
18	通道2各回滞量值 Each hysteresis value in channel 2	Unsigned int	R/W	0.3、04 / 16	1 ~ 40
19	通道3排风设定温度 Temperature set for blowing in channel 3	signed int	R/W	0.3、04 / 16	0 ~ 1000
20	通道3加热设定温度 Humidity set for heating in channel 3	signed int	R/W	0.3、04 / 16	10 ~ 999
21	通道3加热设定温度 Temperature set for heating in channel 3	signed int	R/W	0.3、04 / 16	-400 ~ 1000
22	通道3各回滞量值 Each hysteresis value in channel 3	Unsigned int	R/W	0.3、04 / 16	1 ~ 40
23	保留	Unsigned int	R	0.3、04	
24	保留	Unsigned int	R	0.3、04	
25	保留	Unsigned int	R	0.3、04	

6.2.2 预置多寄存器 (功能码16) Preset multi-register (Function code 16)

查询数据帧 Searching data frame

设置第一路加热升温启动温度值为5℃, 该值在寄存器中的地址是000DH。
主机发送:

The temperature value set for starting the heater in Channel 1 is 5℃, its register address is 0012H. Delivered by host computer:

从机地址 Addr	功能码 Fun	数据起始地址寄存器高字节 Data start reg hi	数据起始地址寄存器低字节 Data start reg lo	数据设置寄存器数量高字节 Data of reg number HI	数据设置寄存器数量低字节 Data of reg number Lo	数据长度 Data long	数据高字节 Data Hi	数据低字节 Data Lo	循环冗余校验低字节 CRC16 lo	循环冗余校验高字节 CRC16hi
01H	10H	00H	0DH	00H	01H	02H	00H	32H	26H	98H

响应数据帧 Response data frame

从机地址 Addr	功能码 Fun	数据起始地址寄存器高字节 Data start reg hi	数据起始地址寄存器低字节 Data start reg lo	数据设置寄存器数量高字节 Data of reg number HI	数据设置寄存器数量低字节 Data of reg number Lo	循环冗余校验低字节 CRC16 lo	循环冗余校验高字节 CRC16 hi
01H	10H	00H	0DH	00H	01H	90H	0AH

三 传感器 Sensor

1 概述 General

WH系列普通型温湿度控制器及WHD系列智能型温湿度控制器的传感器均使用外接方式。传感器部分采用专用外壳, 通风效果好, 外观精致, 既能有效保护内部元件, 提高使用寿命, 又方便安装、接线。

The sensor of WH Series General Purpose Temperature & Humidity Controller and WHD Series Intelligent Temperature & Humidity Controller adopt external connecting mode, and special housing with advantages of good ventilation, aesthetic appearance, protect inner component effectively, boost service life, easily mounting and wiring.

2 型号说明 Type explanation

■ WH系列普通型温湿度控制器传感器

(WH Series general purpose temperature & humidity controller sensor):

型号 (Type)	功能 (Function)	接线 (Wiring)	安装方式 (Mounting mode)	外形、尺寸 (Outline, size)
W-1	1路温度传感器 One temperature sensor	<p>21、22为温度信号输出, 与控制器连接; 23、24无用途 21,22 is temperature signal output, connected with controller; 23,24 not applicable</p>	导轨式 固定式	
H-1	1路湿度传感器 One humidity sensor	<p>23、24为湿度信号输出, 与控制器连接; 21、22无用途 23,24 is humidity signal output, connected with controller; 21,22not applicable</p>		
WH-1	1路温度传感器及1路湿度传感器 One temperature sensor and one humidity sensor	<p>21、22为温度信号输出, 23、24为湿度信号输出, 分别与控制器连接 21,22 is temperature signal output, 23,24 is humidity signal output; connected with controller respectively.</p>		

■ WHD系列智能型温湿度控制器传感器

(WHD Series Intelligent purpose temperature & humidity controller sensor):

型号 (Type)	功能 (Function)	接线 (Wiring)	安装方式 (Mounting mode)	外形、尺寸 (Outline, size)
WH-2	1路温、湿度 One temperature humidity	<p>V+、V-、CLK、Data分别与控制器对应接线端连接 V+, V-, CLK, Data is connected with the controller's matched wiring terminal respectively.</p>	导轨式 固定式	